



## Classic 'Six'



## Classic 'Eight'



## Classic 'Ten'













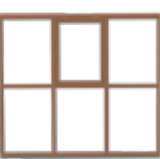

## Classic 'Twelve'





Overview - Oversigt - Übersicht - Översikt - Détails -  
 Overzicht - Sisällys - Zawartość - Oversikt - Visión general

	
	4 - 6
	7 - 8
	9 - 10
	11 - 18
	19 - 22
	23 - 30
	31
	32 - 33
	34 - 38
	39

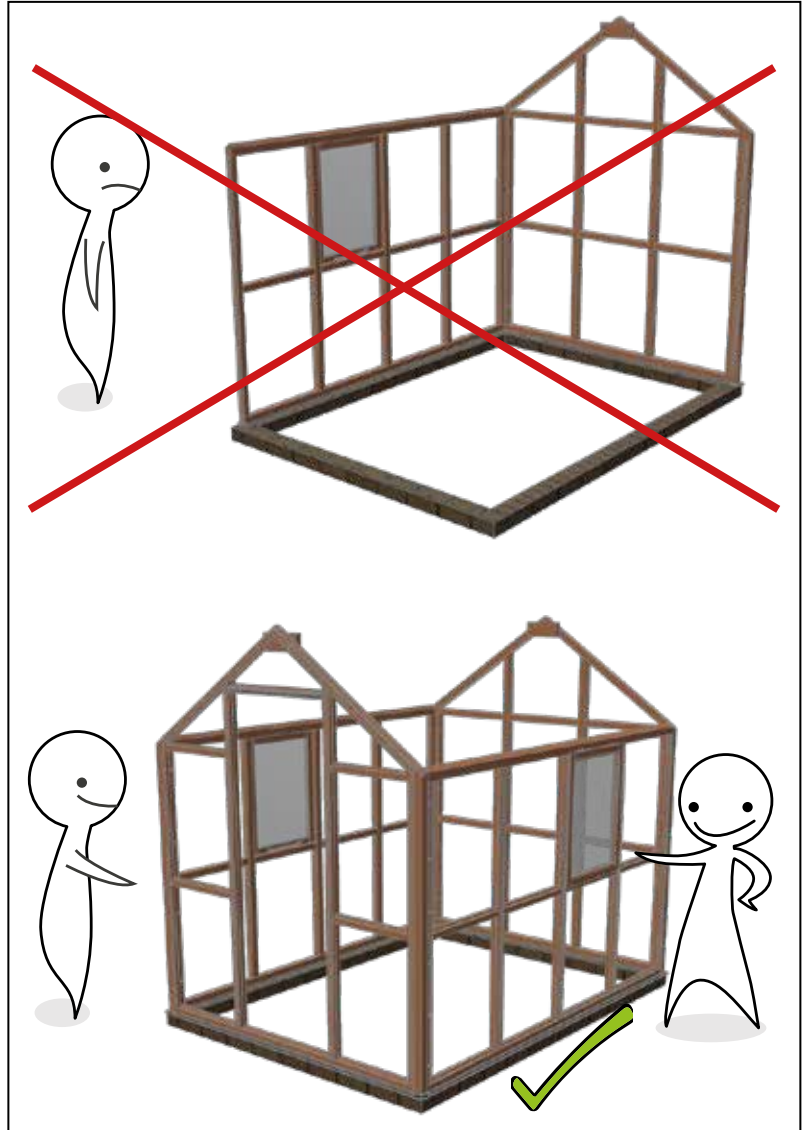

Portal Frame - Portalramme - Portalrahmen - Portal ram - Portique - Portaal frame -  
 Portaalin kehys - Rama portalu - Portalramme - Marco del pórtico

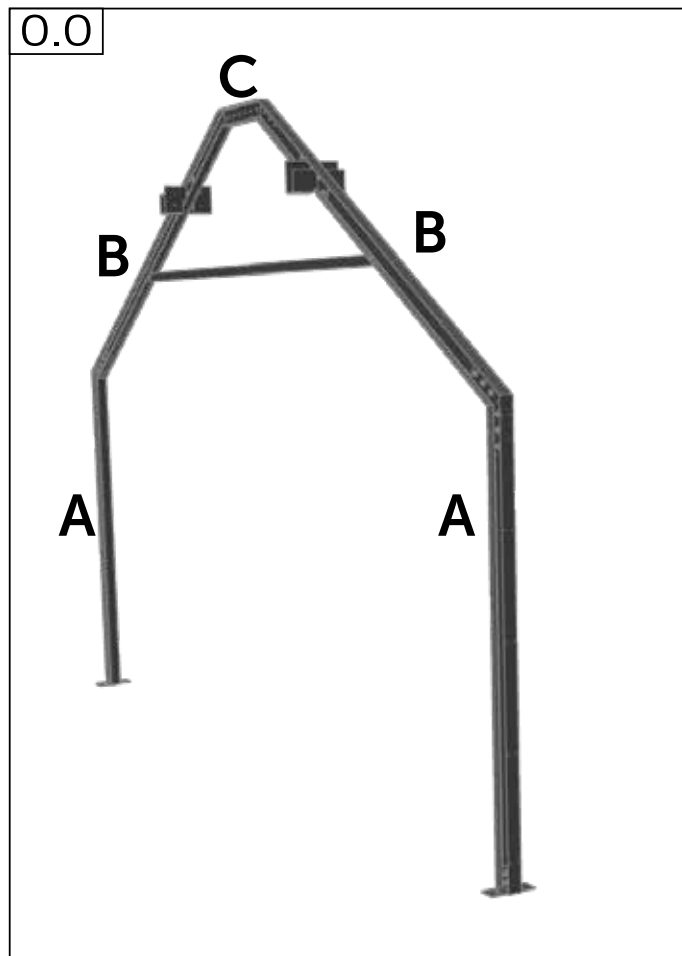
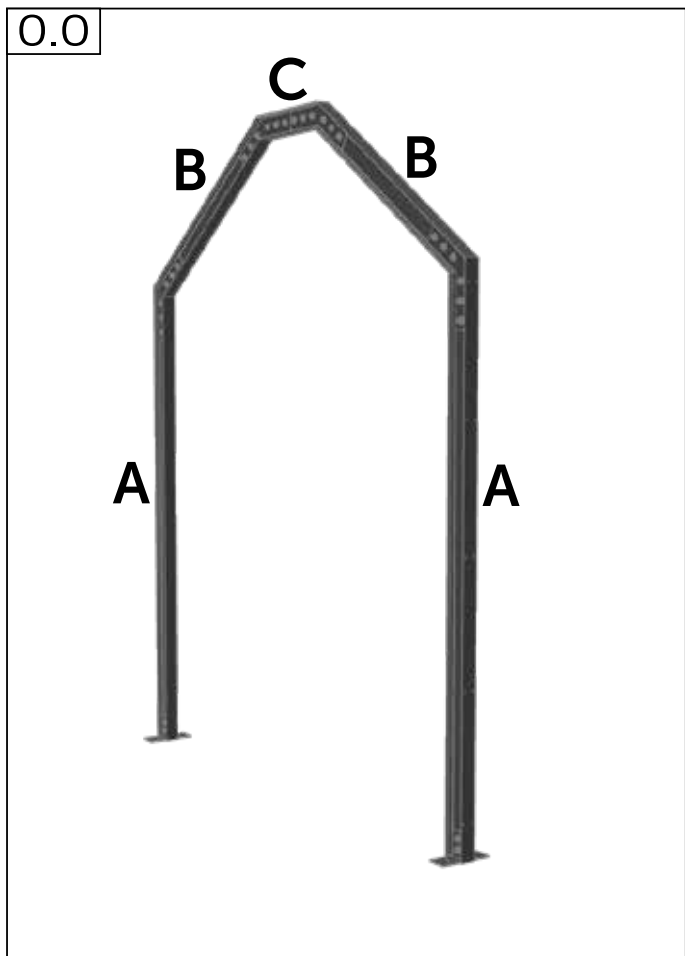

	#	mm
	AL3067	-
	AL3060	-
	AL3059	-
	A AL2018	1559
	B AL2018	0851
	B AL2018	1199
	B AL2018	1596
	B AL2018	1894
	C AL2018	0341
	BL153	M8 x 20
	WA205	M8
	NU102	M8

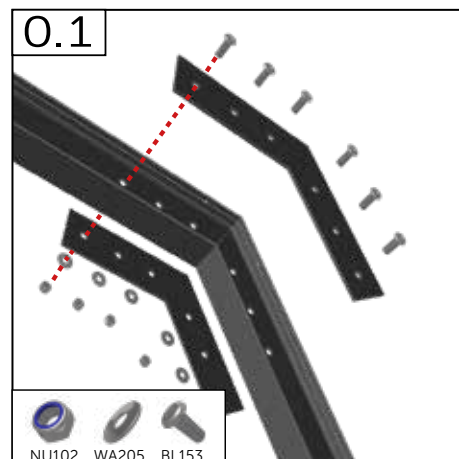
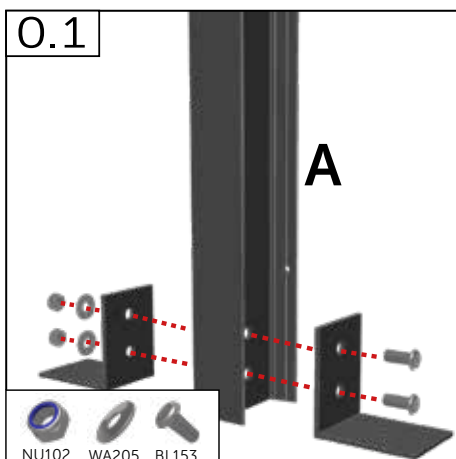
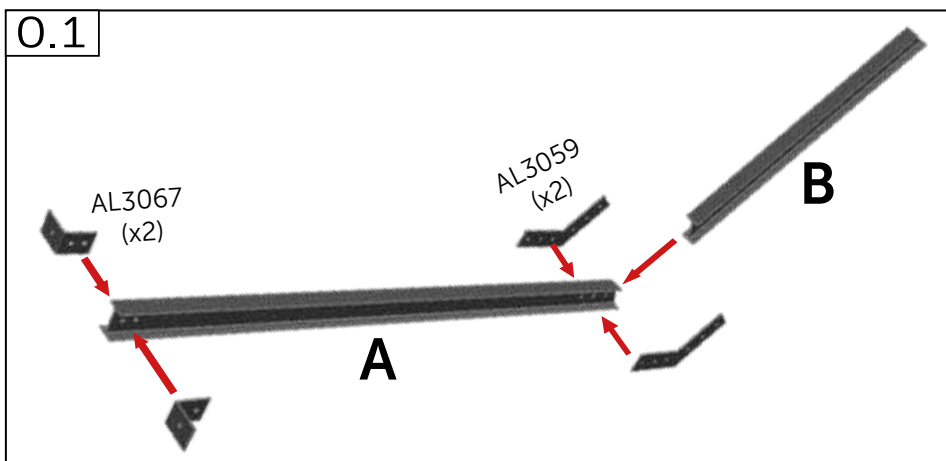



0.2

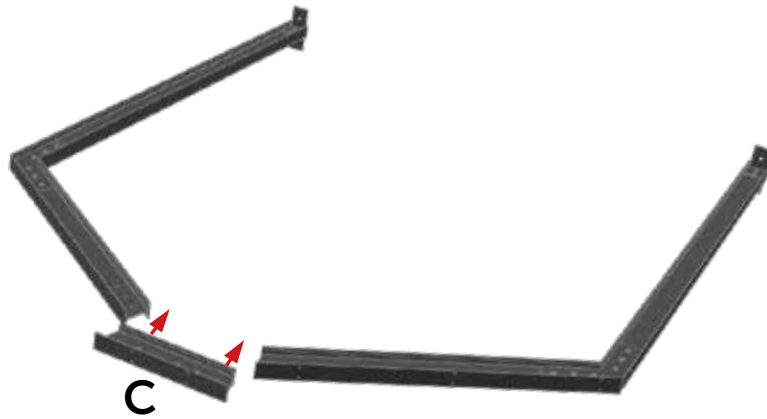

0.3

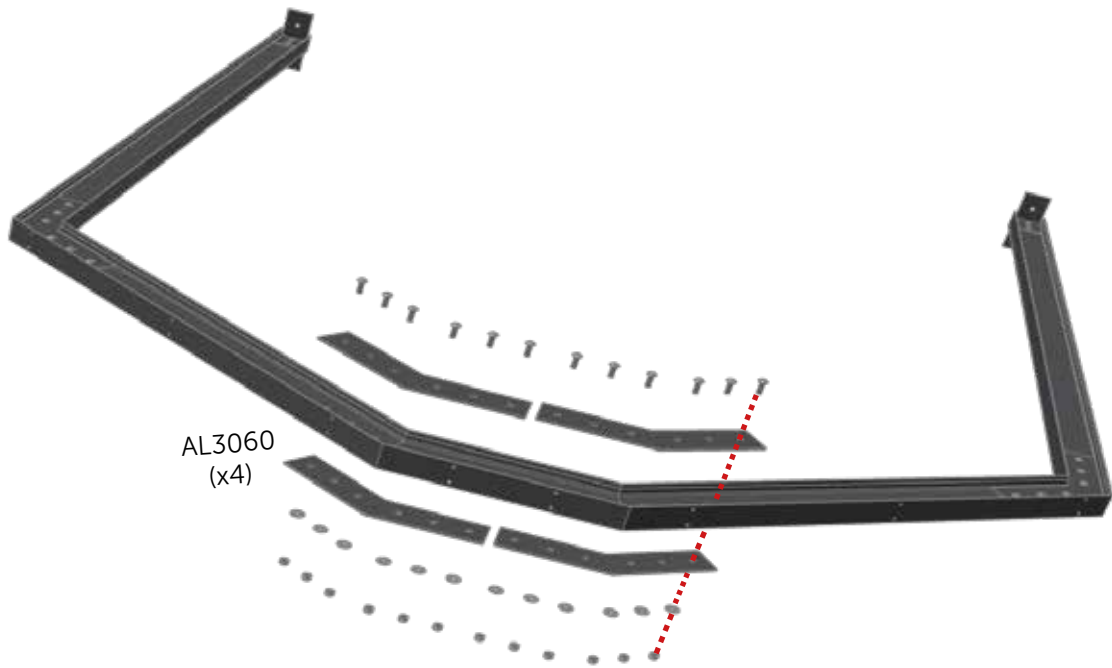





0.4

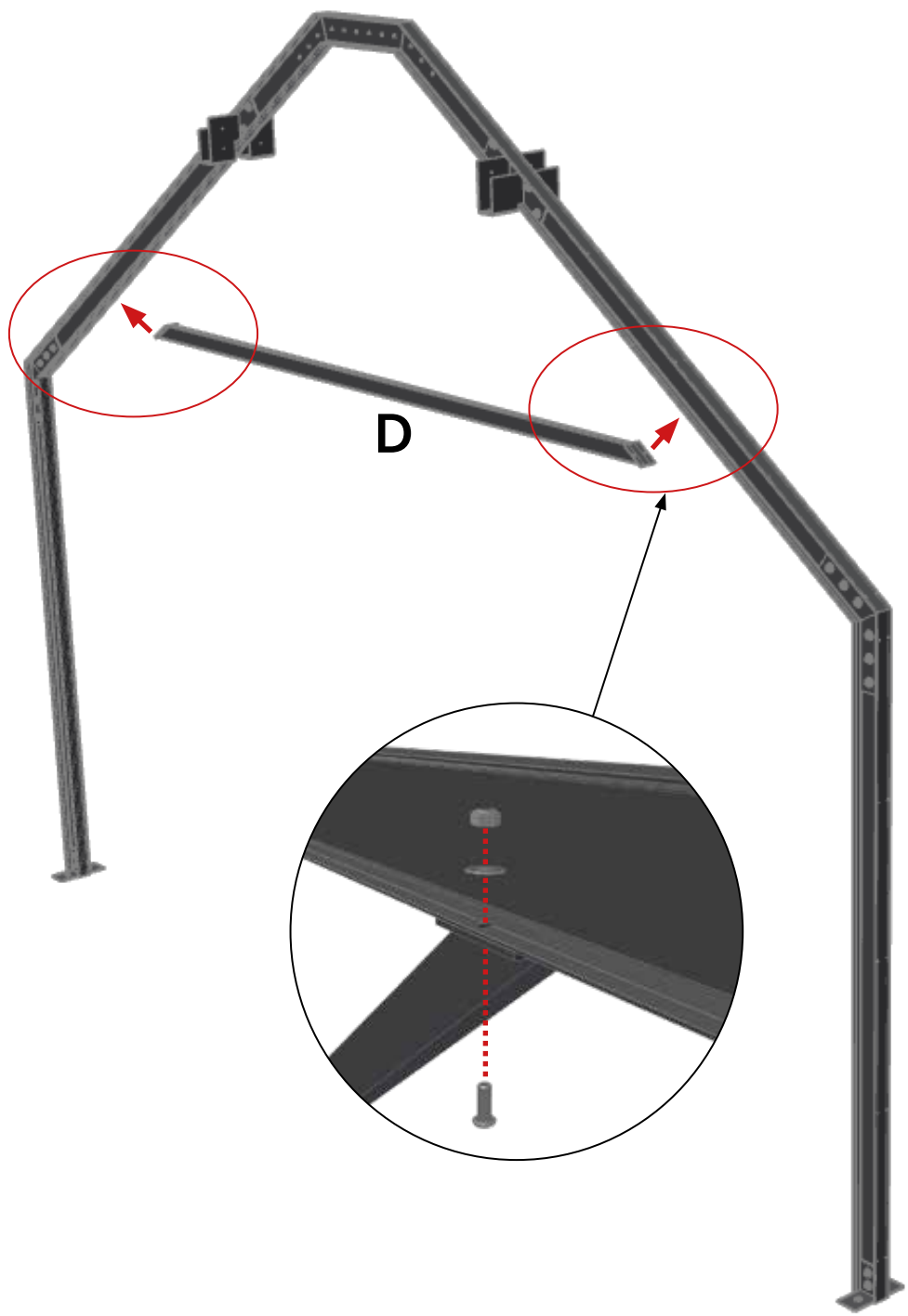

(Classic 12 Only) Portal Frame - Portalramme - Portalrahmen - Portal ram - Portique -  
 Portaal frame - Portaalin kehys - Rama portalu - Portalramme - Marco del pórtico

0.5



	#	mm
	D AL3085	2008
	BL122	M6 x 16
	WA106	M6
	NU101	M6

Gables - Gavle - Giebel - Gavlar - Pignons - Gevels - Päädyt - ściana szczytowa - Gavler - Aguilones

	#	mm
	SA8000	Classic 'Six'
	SA8001	Classic 'Six'
	SA8007	Classic 'Eight'
	SA8016	Classic 'Eight', 'Ten', 'Twelve'
	SA8017	Classic 'Eight'
	SA8022	Classic 'Ten'
	SA8023	Classic 'Ten'
	SA8018	Classic 'Ten'
	SA8024	Classic 'Twelve'
	SA8019	Classic 'Twelve'
	W013-01	-
	W013-02	-
	SC024	4.2 x 38
	SC027	4.2 x 65
	SC026	4.2 x 50
	WA301	No. 8

1.0



1.1

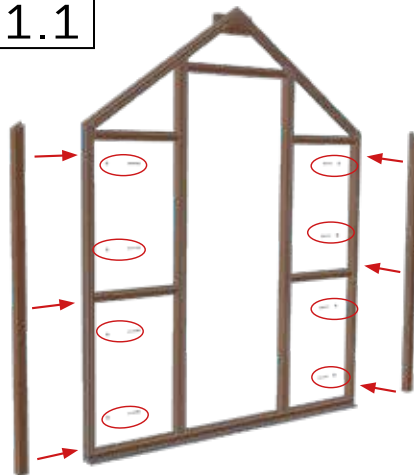

WA301



SC027



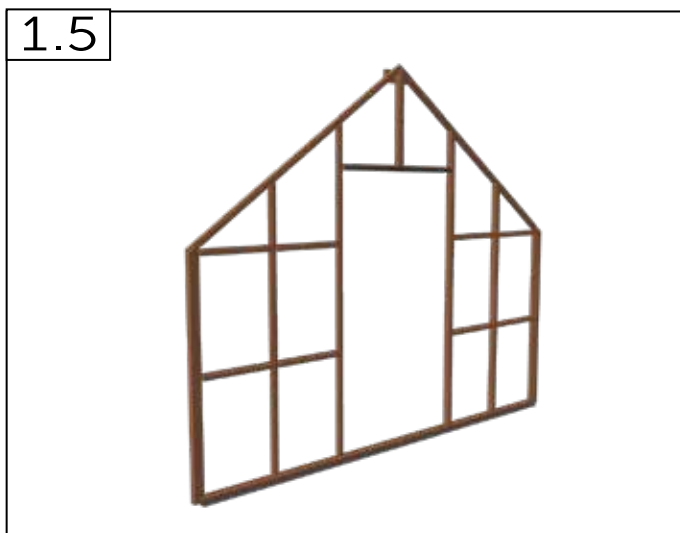
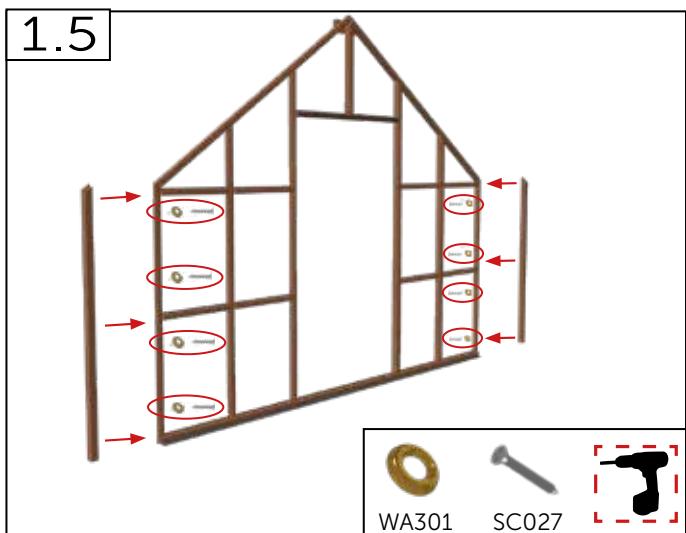
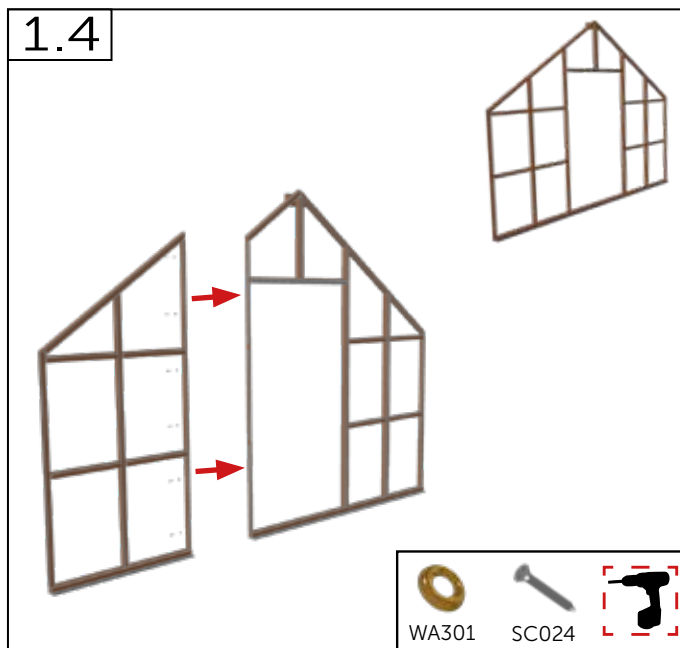
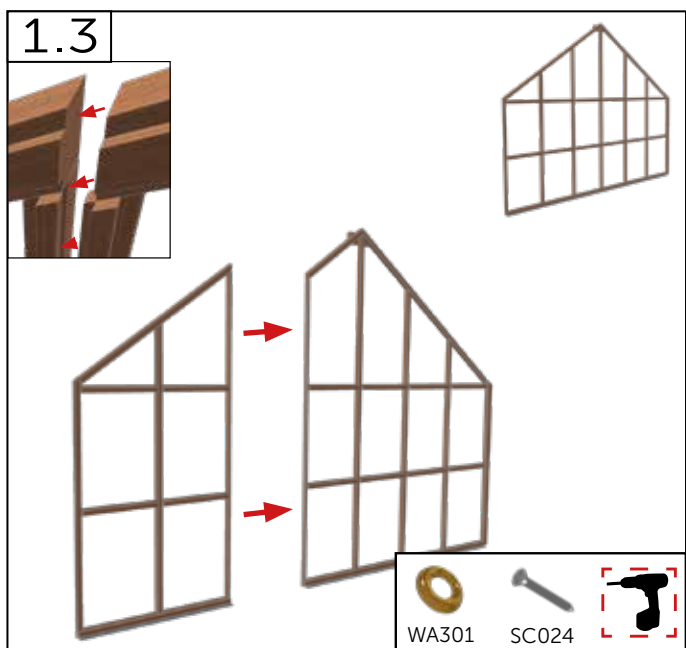
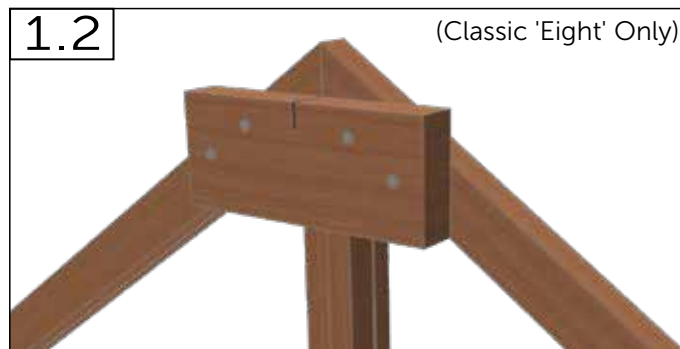
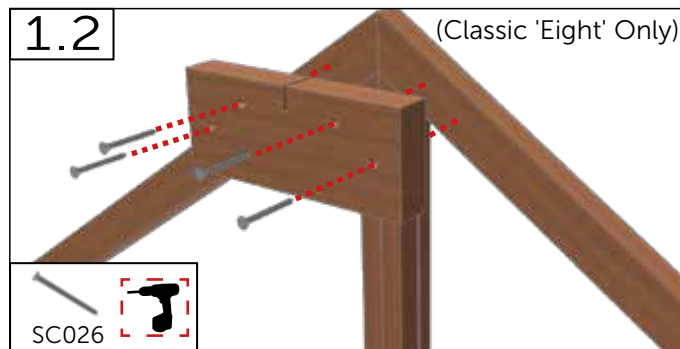
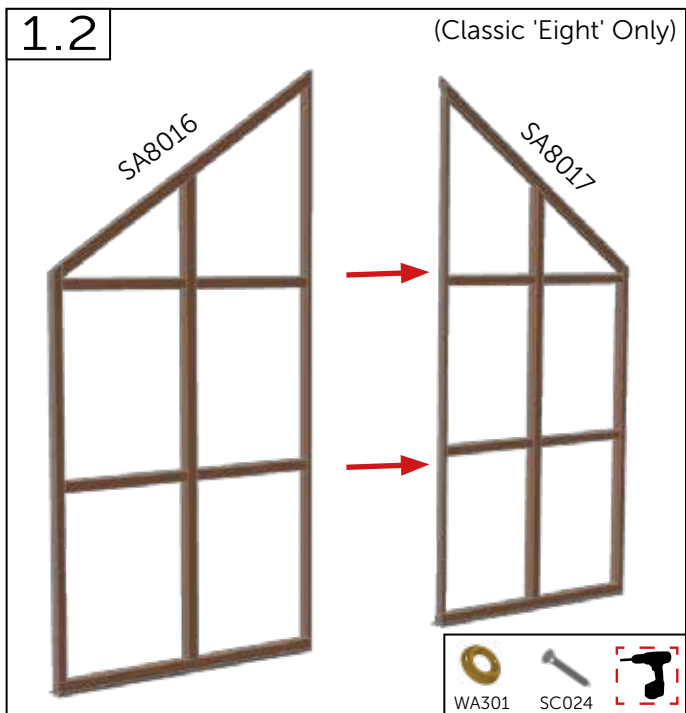

(Classic 8', 10', 12') Gables - Gavle - Giebel - Gavlar - Pignons - Gevels - Päädyt - ściana szczytowa - Gavler - Aguilones

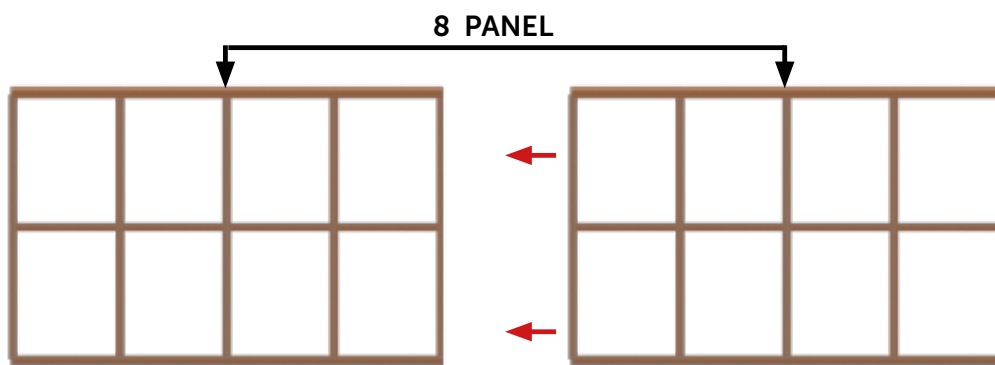
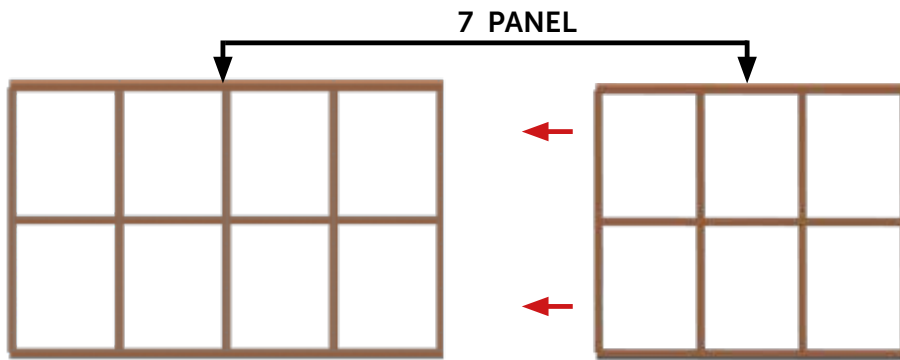
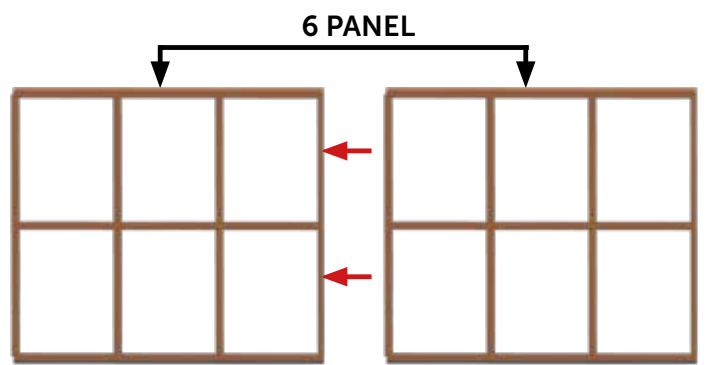
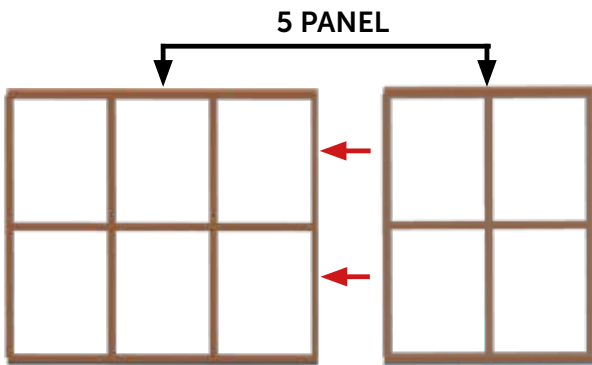
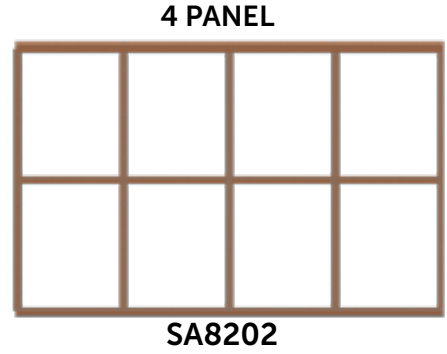
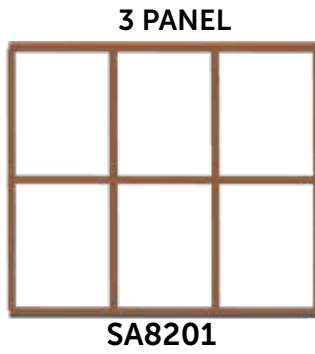

2.0



	#	mm
	SC027	4.2 x 65
	SC301	No. 8

2.0

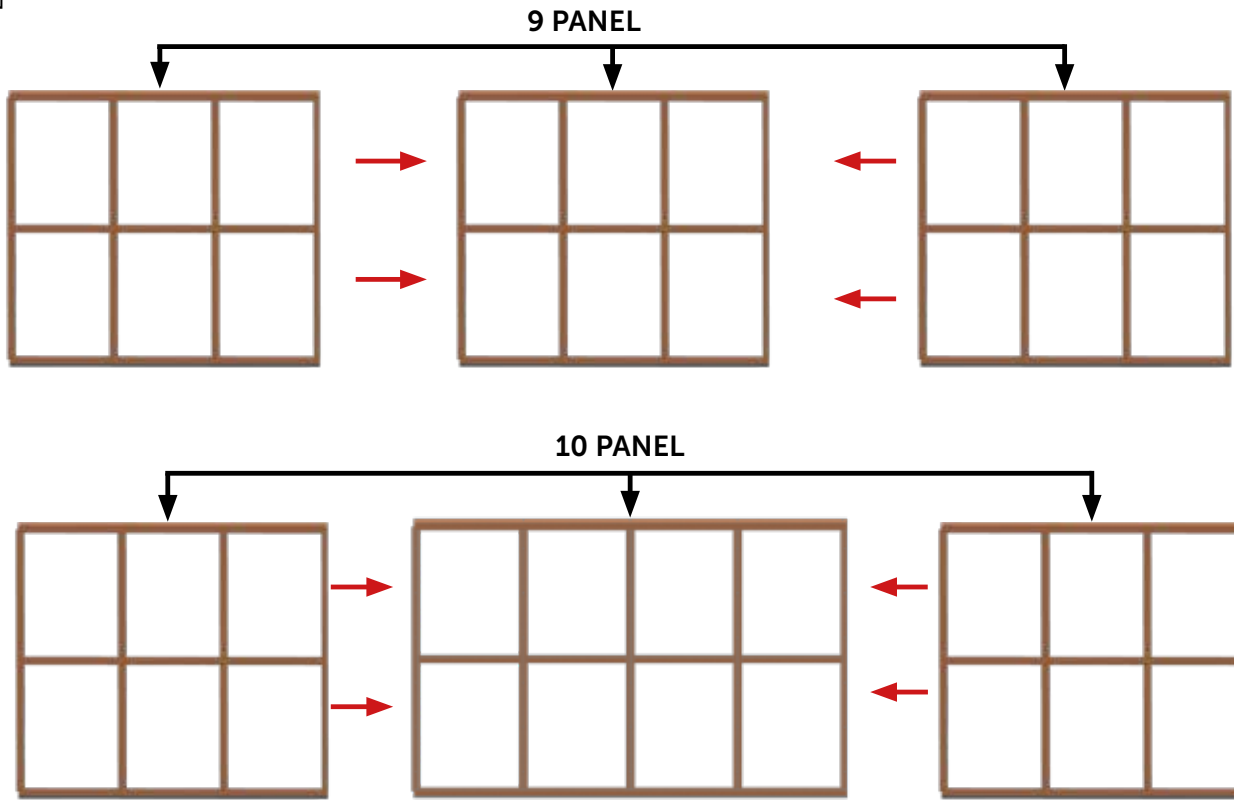

2.1



2.2



2.1

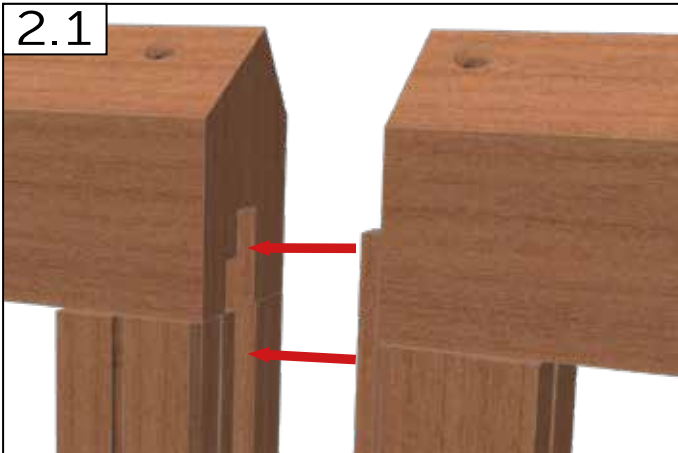

2.2

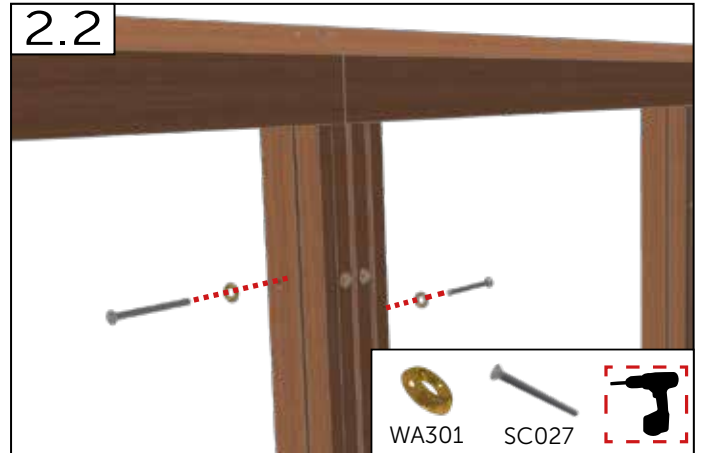



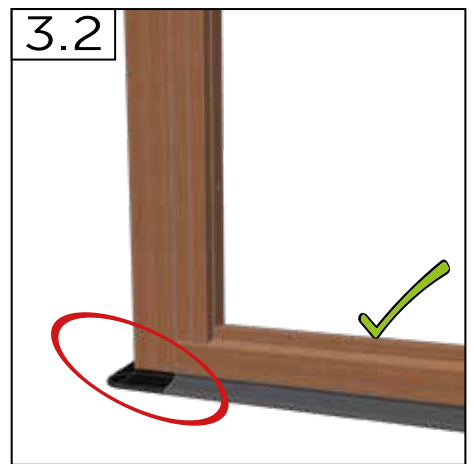
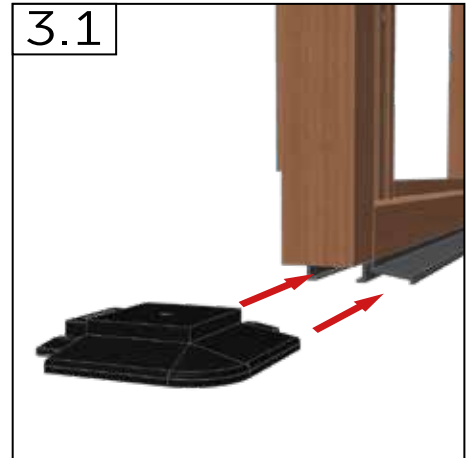
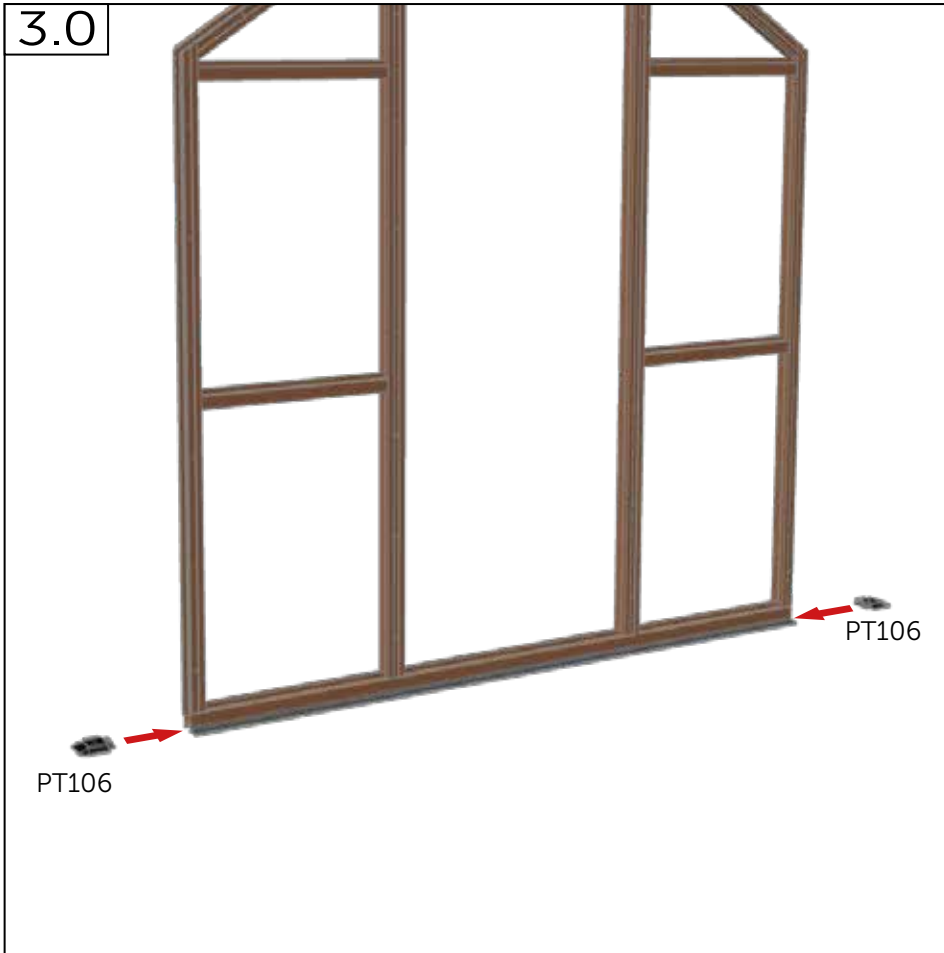

	#	mm
	PT106	-
	SC027	4.2 x 65
	WA301	No. 8

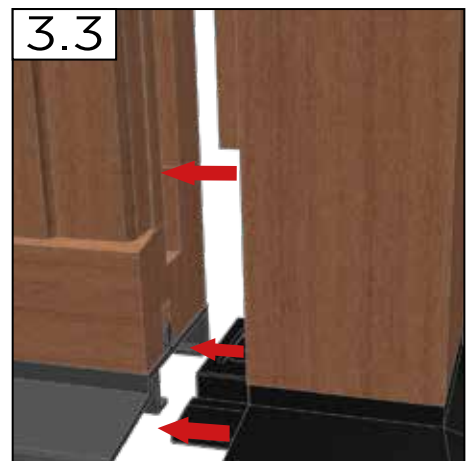
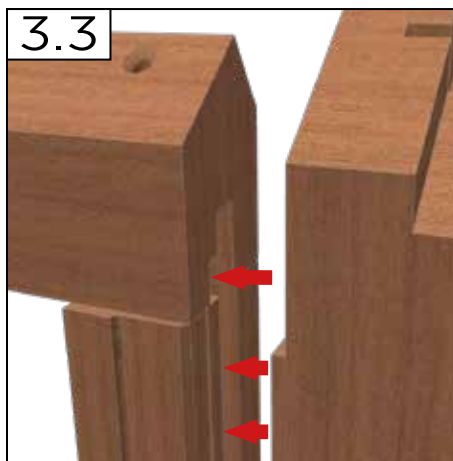
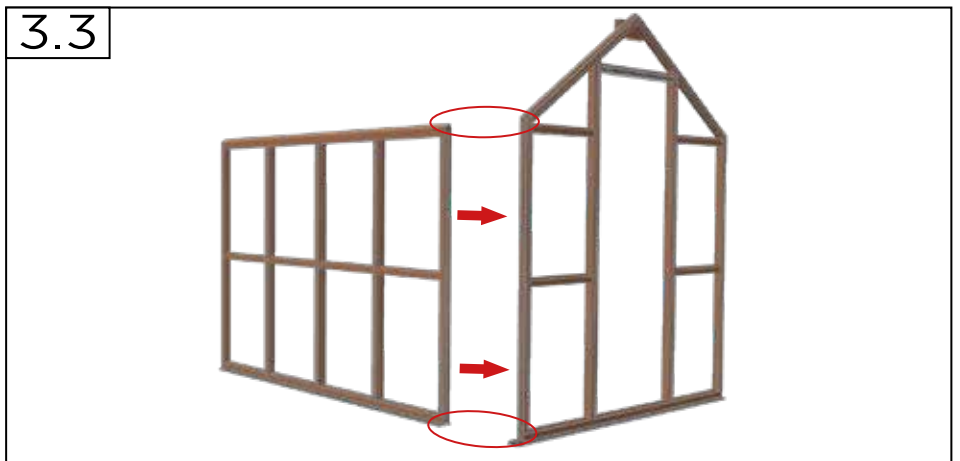

3.4

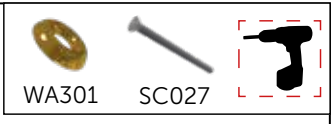

3.5

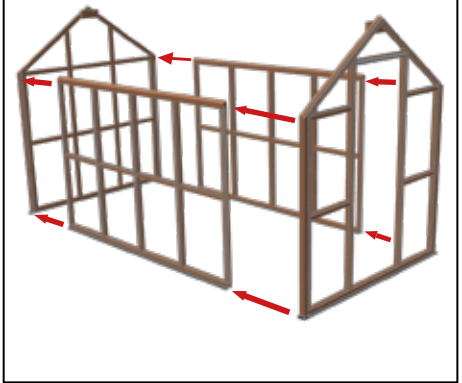

3.6

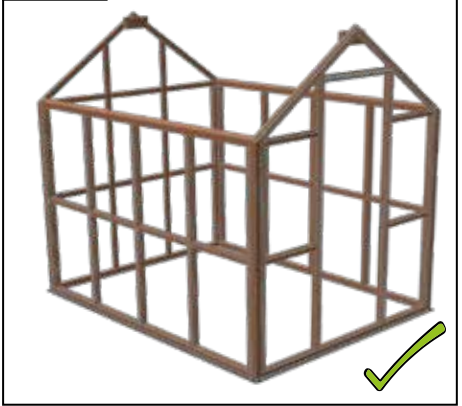

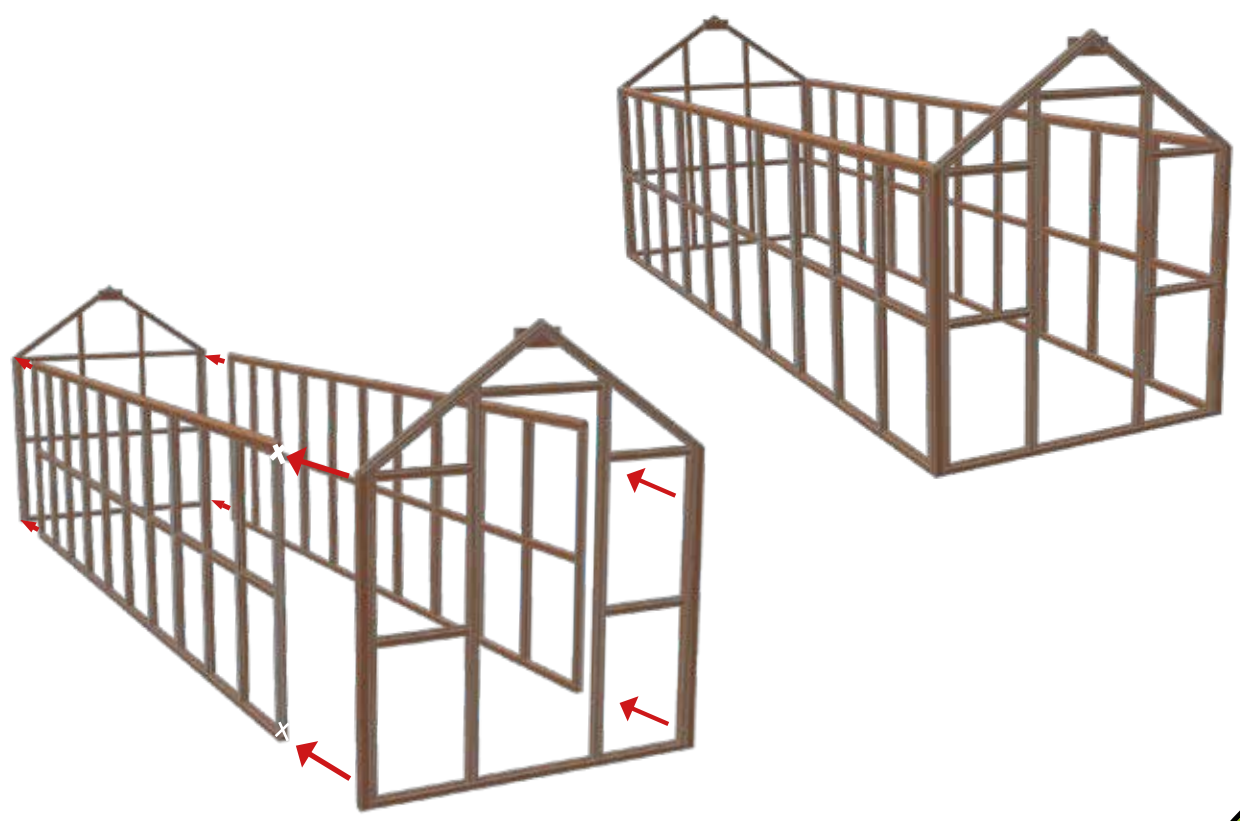

3.7

(Extension Length Only)







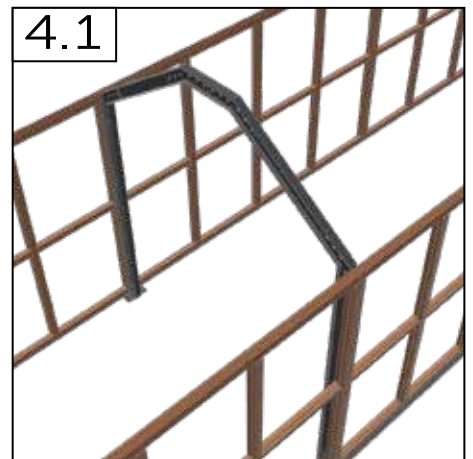
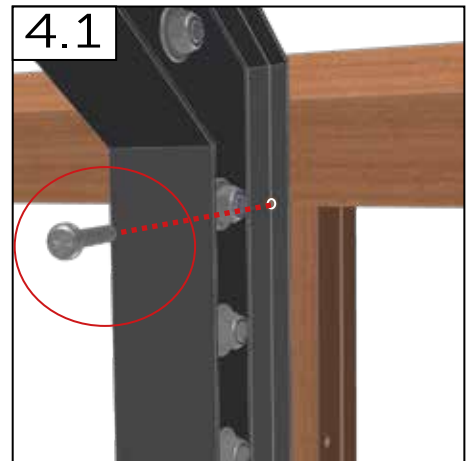
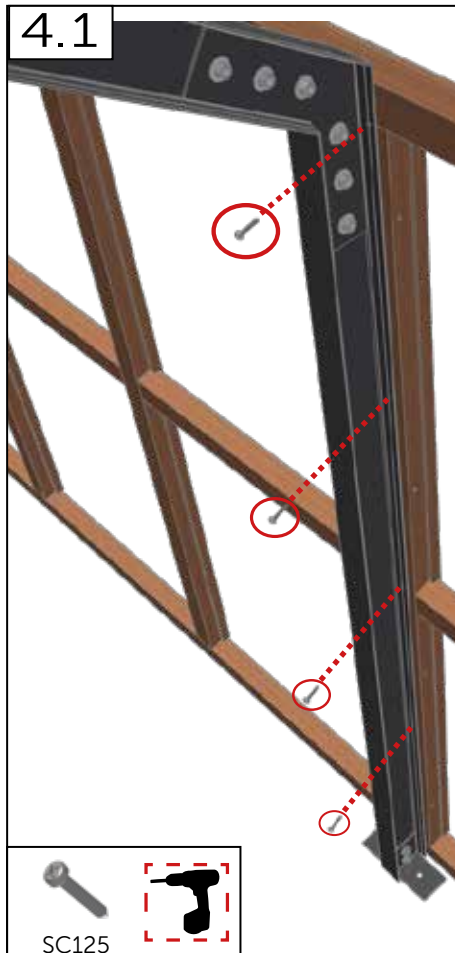

4.0

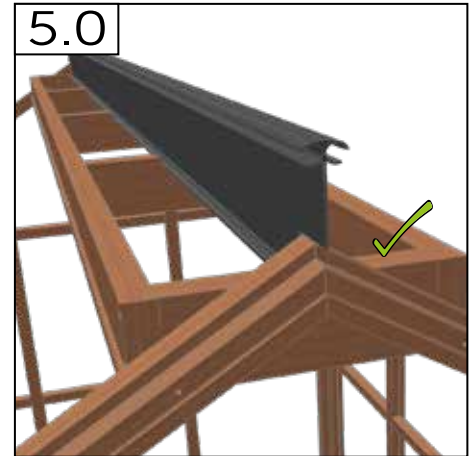
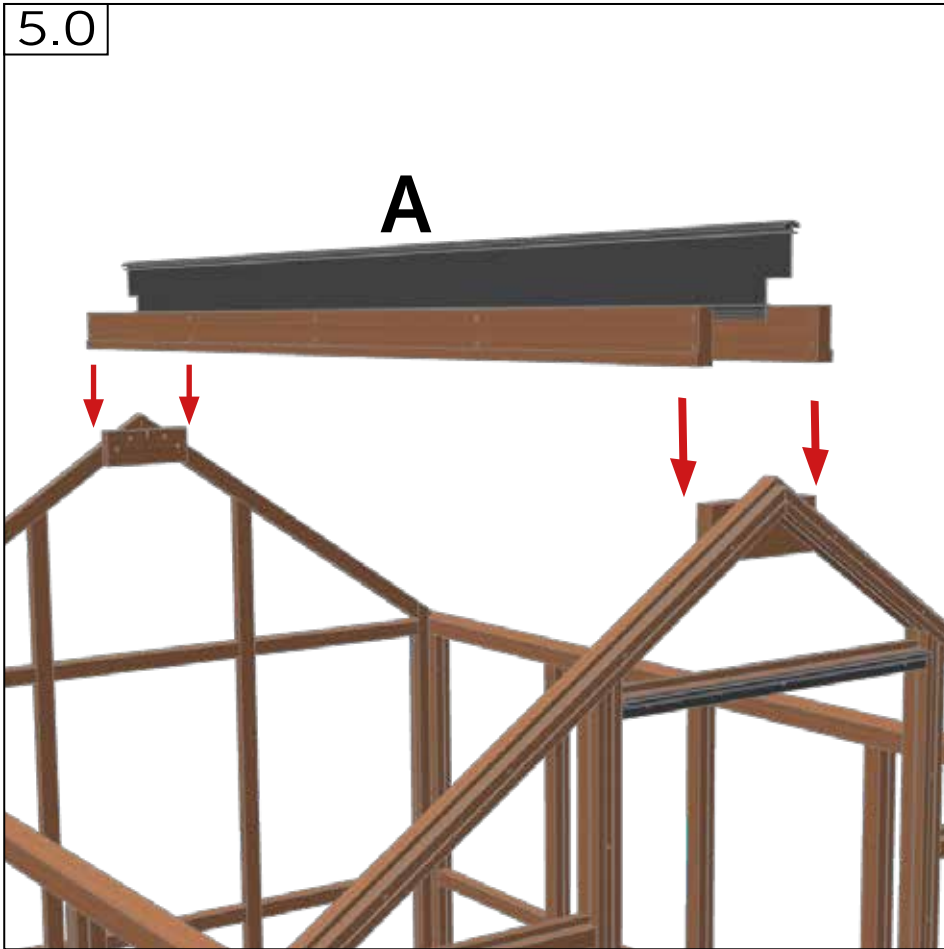

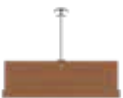
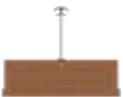
	#	mm
	-	-
	SC125	4.2 x 25





	#	mm
	A	
	B	
	AD001	70
	BL153	M8 x 20
	WA205	M8
	NUT	M6
	AL3043	-
	SC027	4.2 x 65

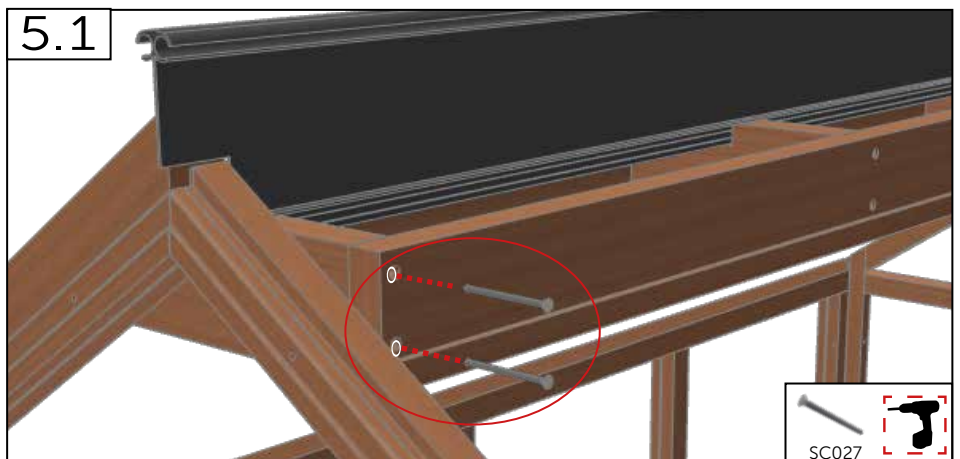



5.0

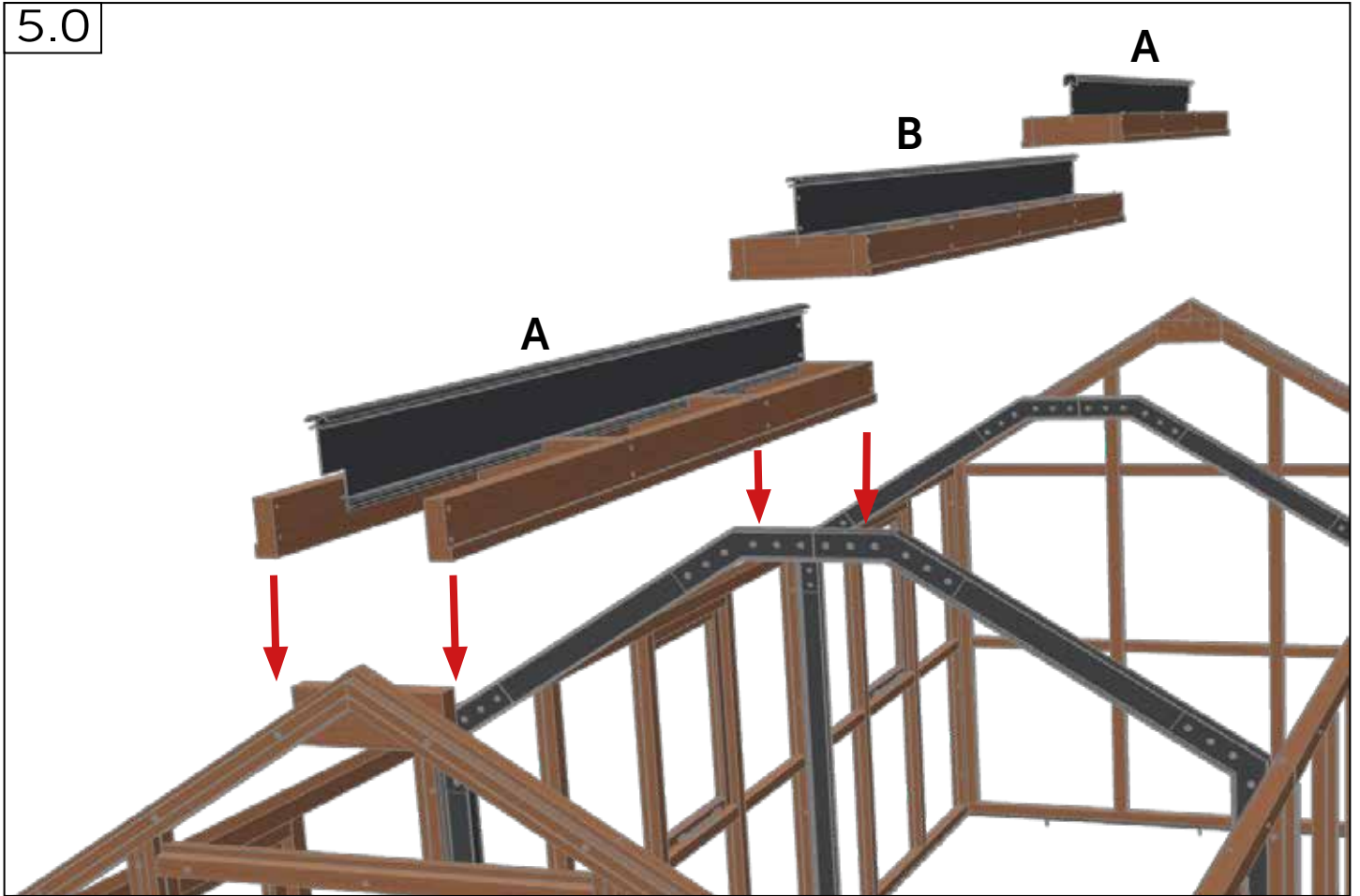

5.1

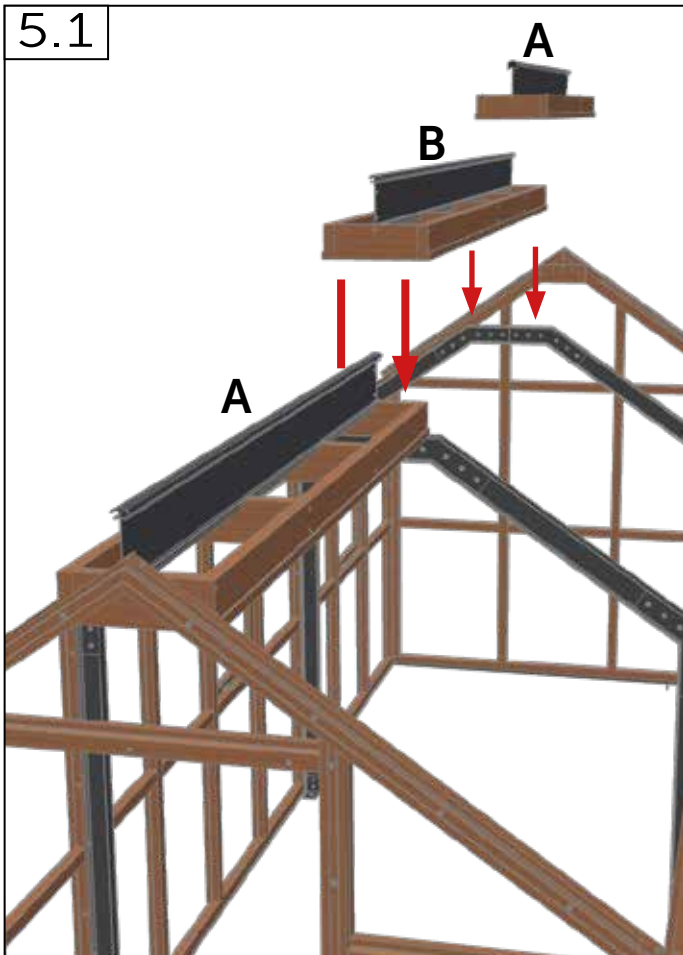

5.2

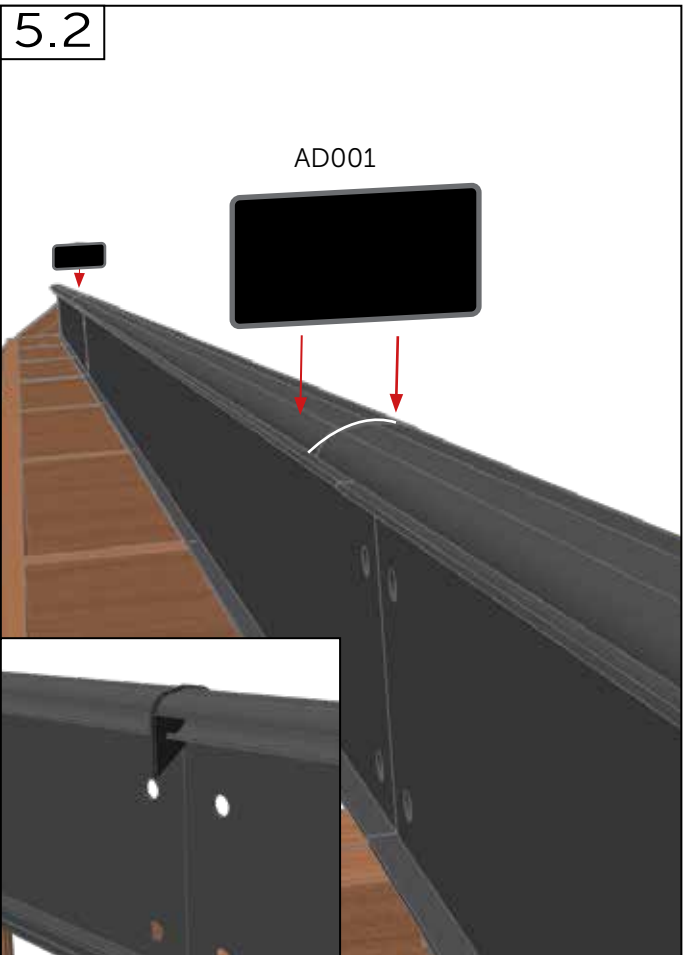

5.3

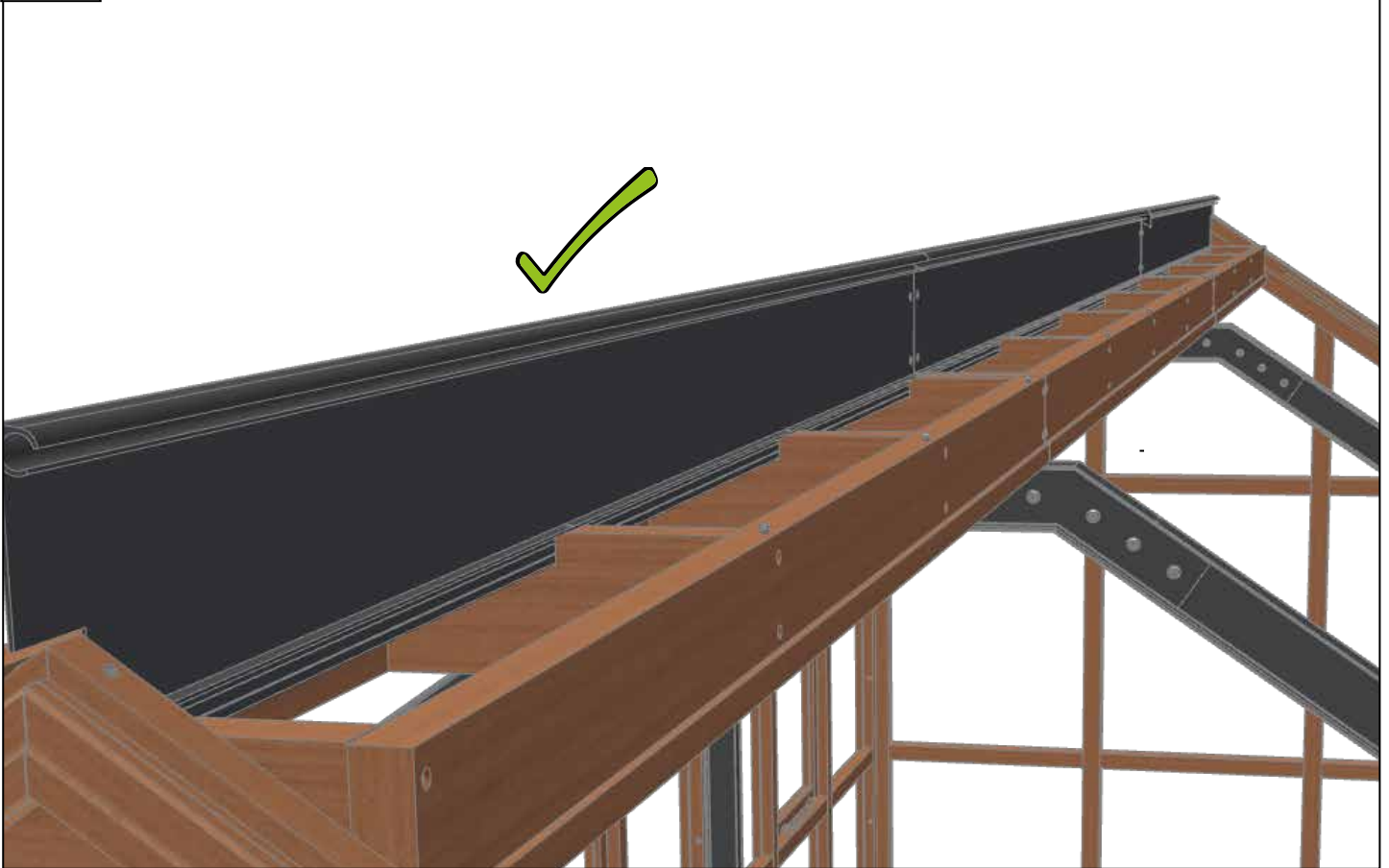

5.4

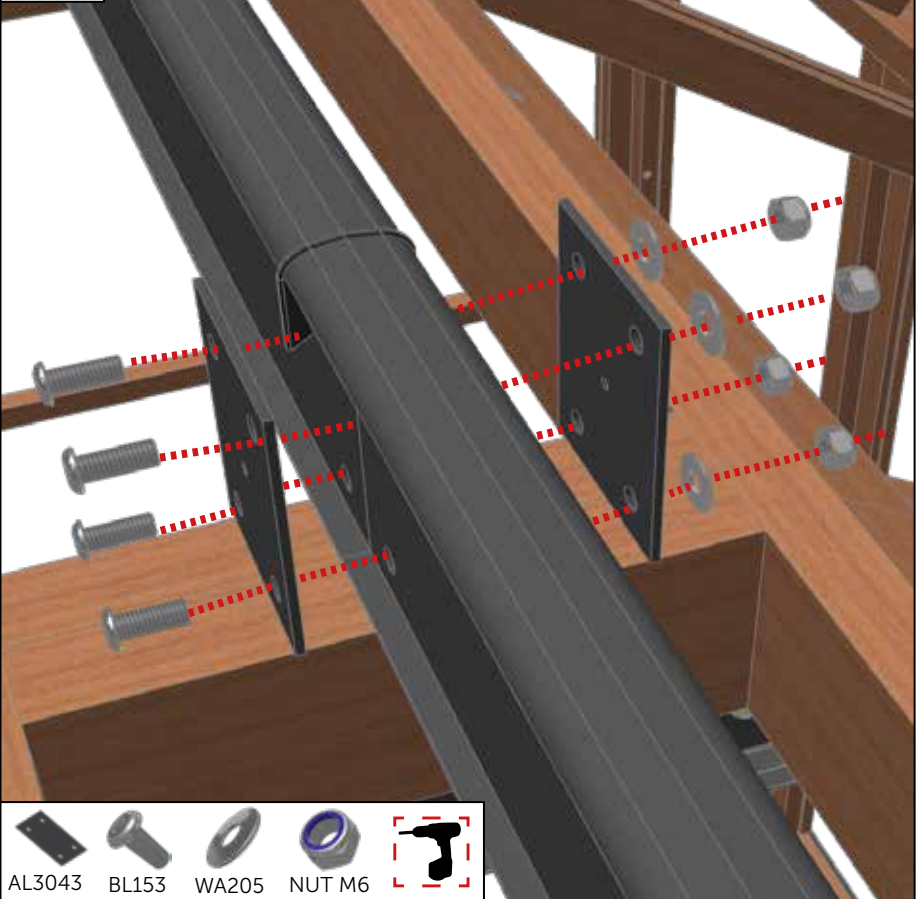

5.5



5.5

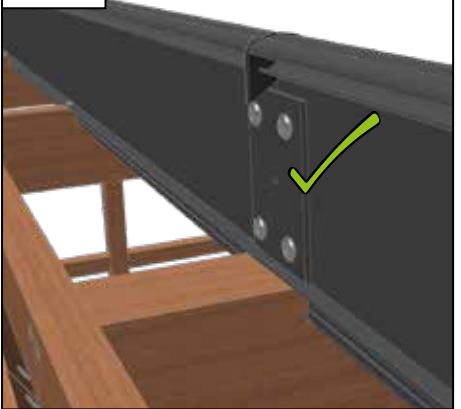



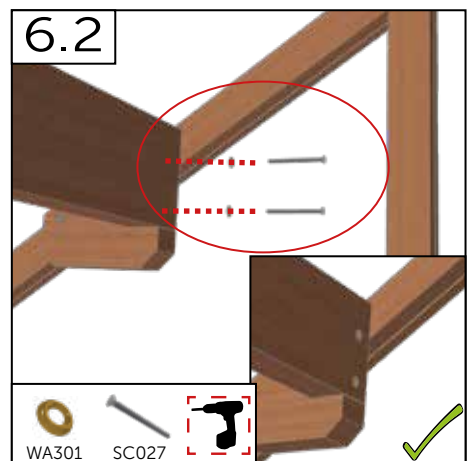
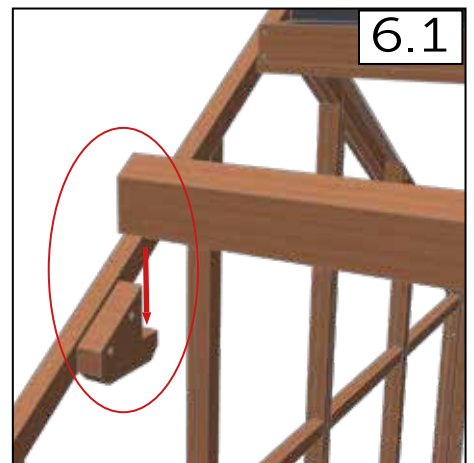
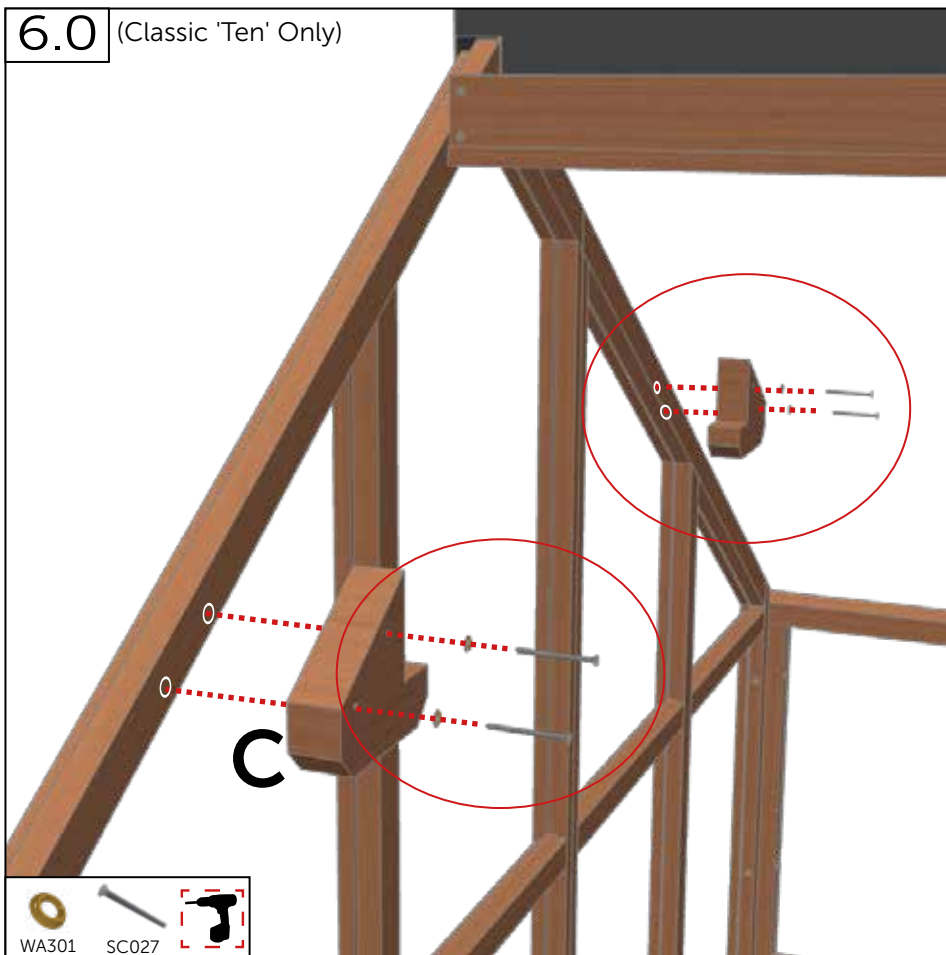
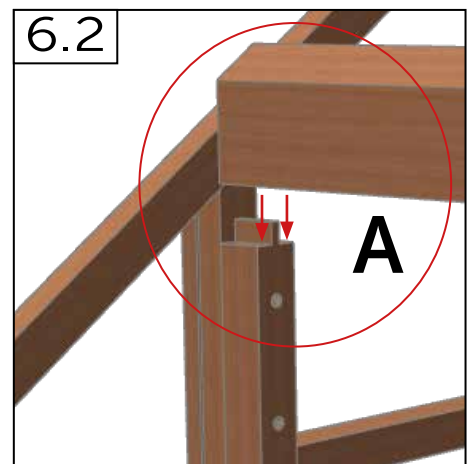
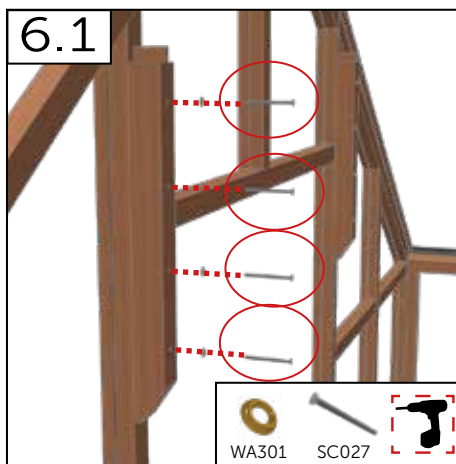
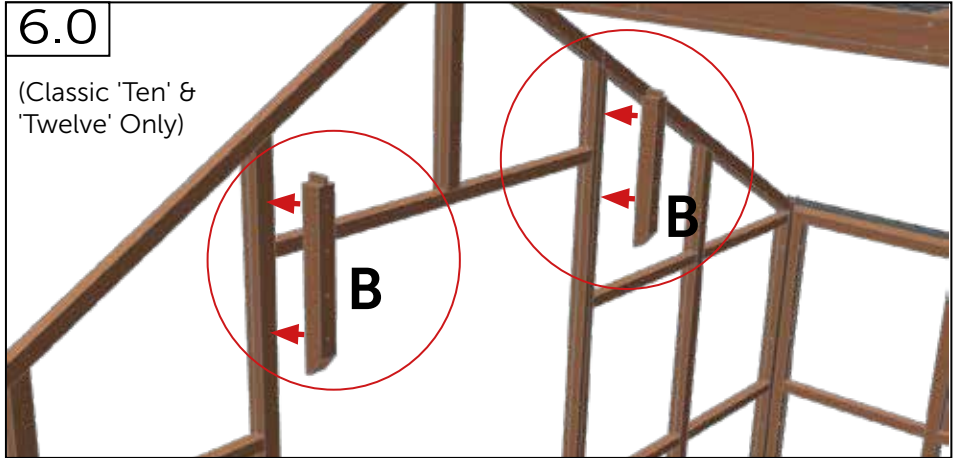

(Classic 10', 12') Assemble - Samilng - Verbinden - Montera - Assemblage  
 - Monteren - kokoaminen - Montaż stelaża - Montere - Armar

	#	mm
	B W475-300	-
	C W488-300	-
	SC027	4.2 x 65
	WA301	No. 8
	A W093	-

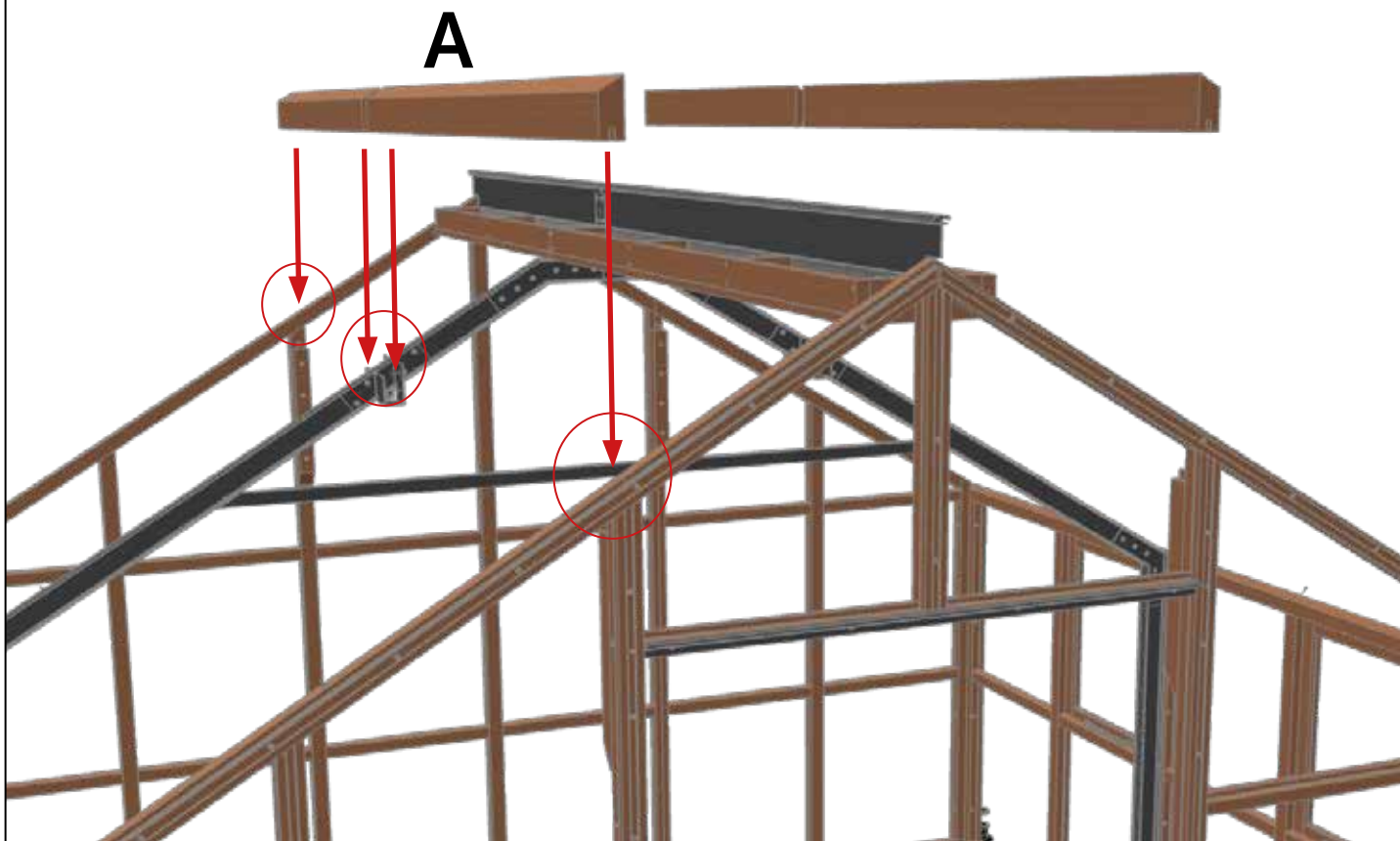

6.0



	#	mm
	A W093	-
	SC125	4.2 x 25

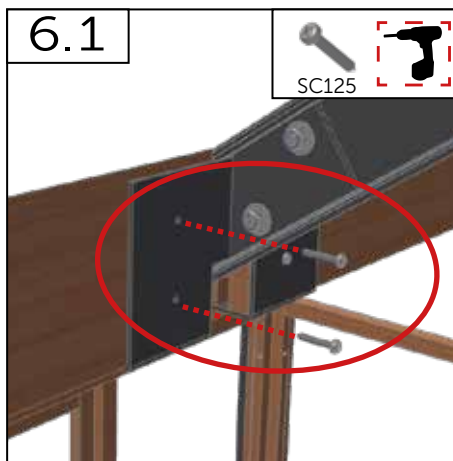

7.0

2 PANEL

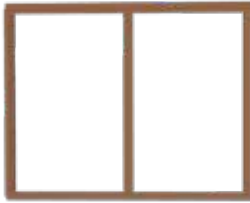

3 PANEL



4 PANEL



5 PANEL

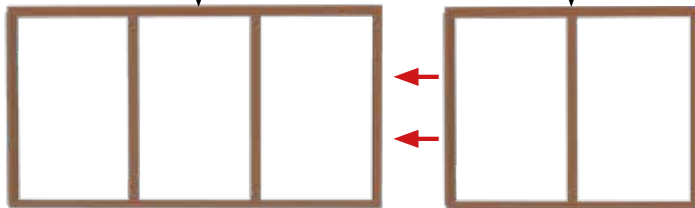

6 PANEL

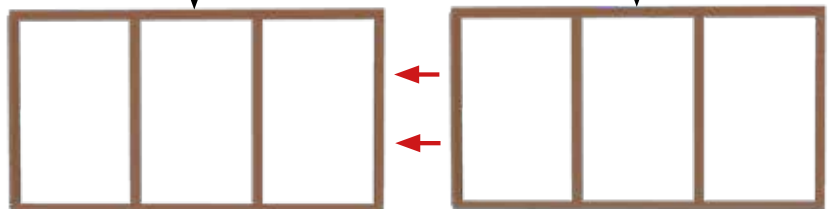

7 PANEL

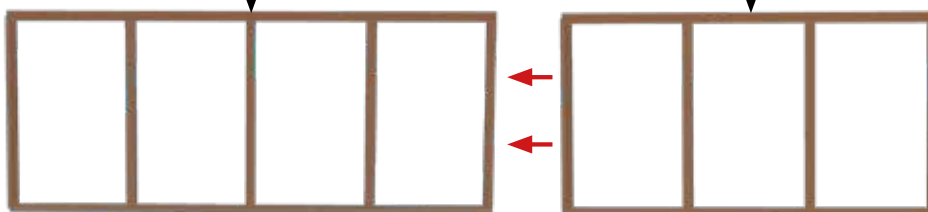

8 PANEL

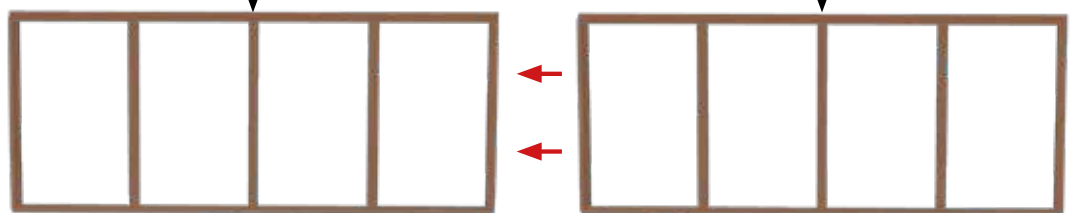

	#	mm
	SC027	4.2 x 65
	WA301	No. 8
	W010	-
	W055	-

7.0

9 PANEL

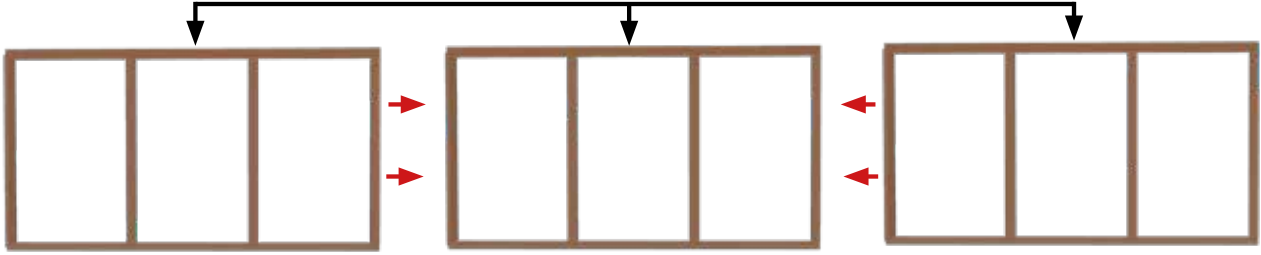

10 PANEL

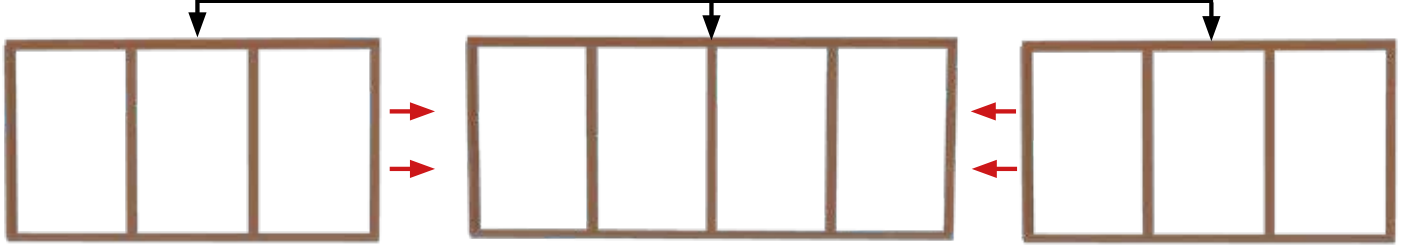

7.1

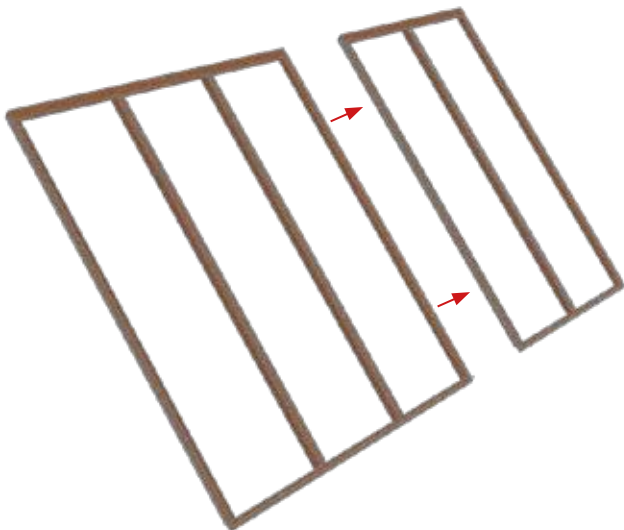

7.1

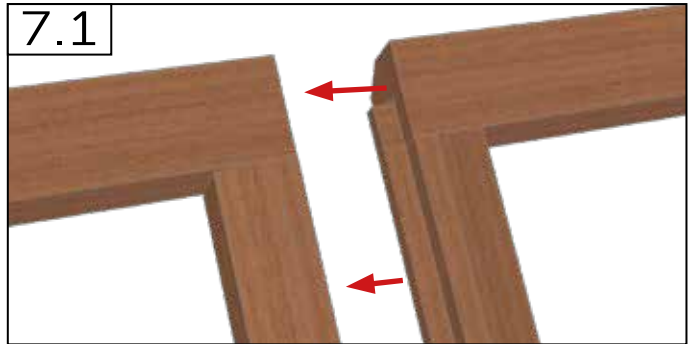

7.1

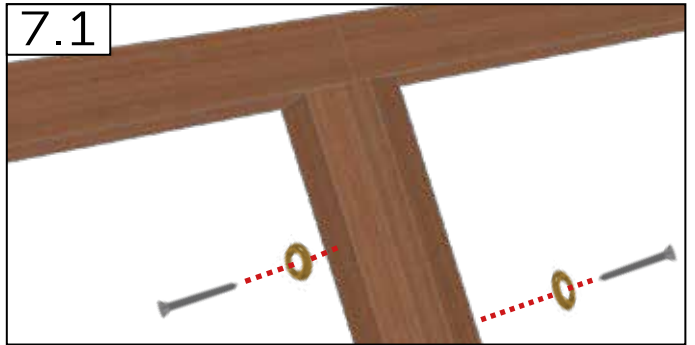

7.2

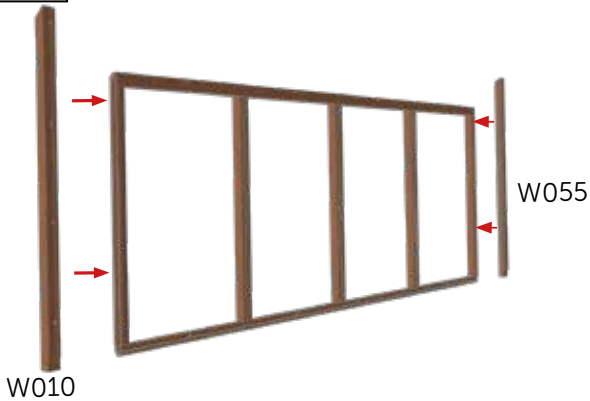

7.2

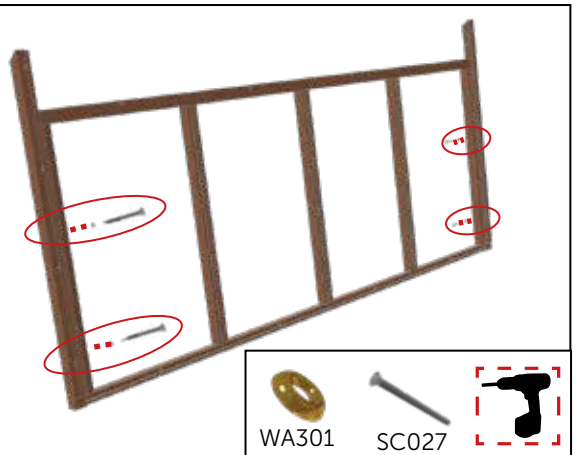



8.0

	#	mm
	SC027	4.2 x 65
	WA301	No. 8
	SC125	4.2 x 25
	SC026	4.2 x 50

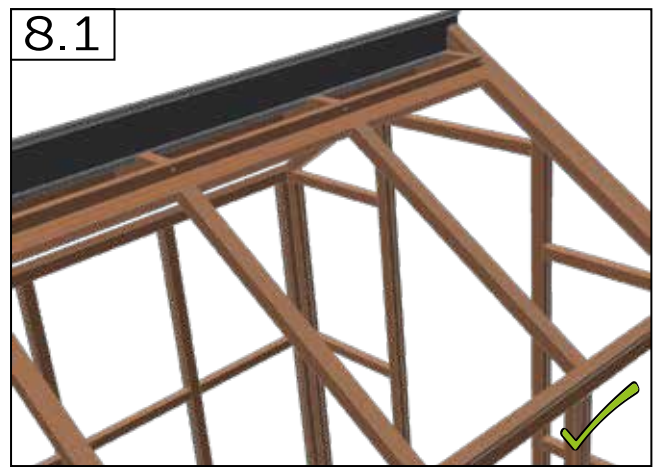

8.2

SC027

8.3

SC026

8.4

SC026

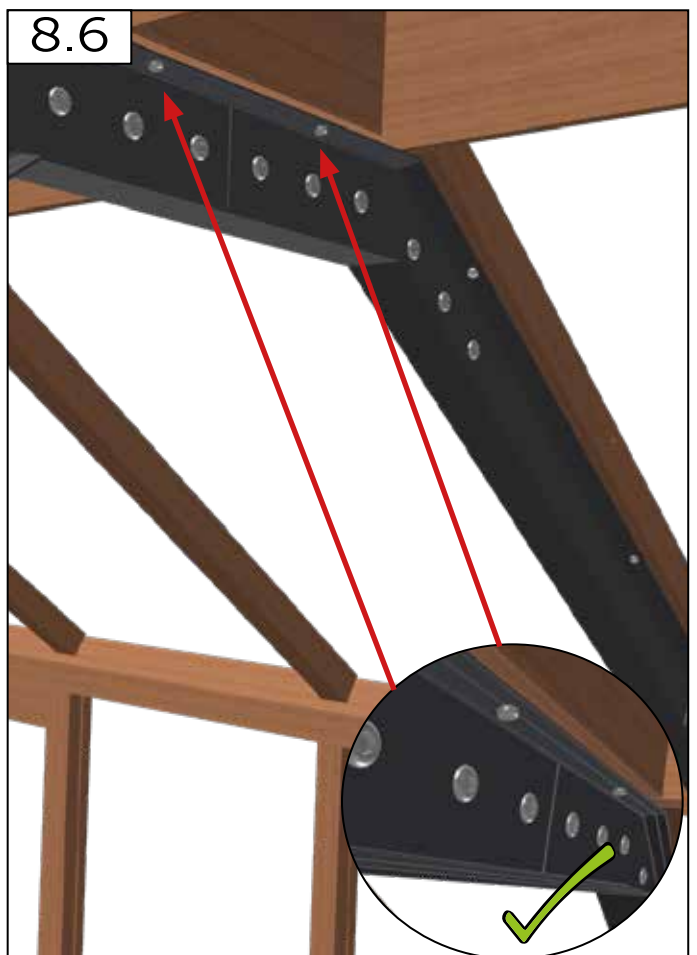
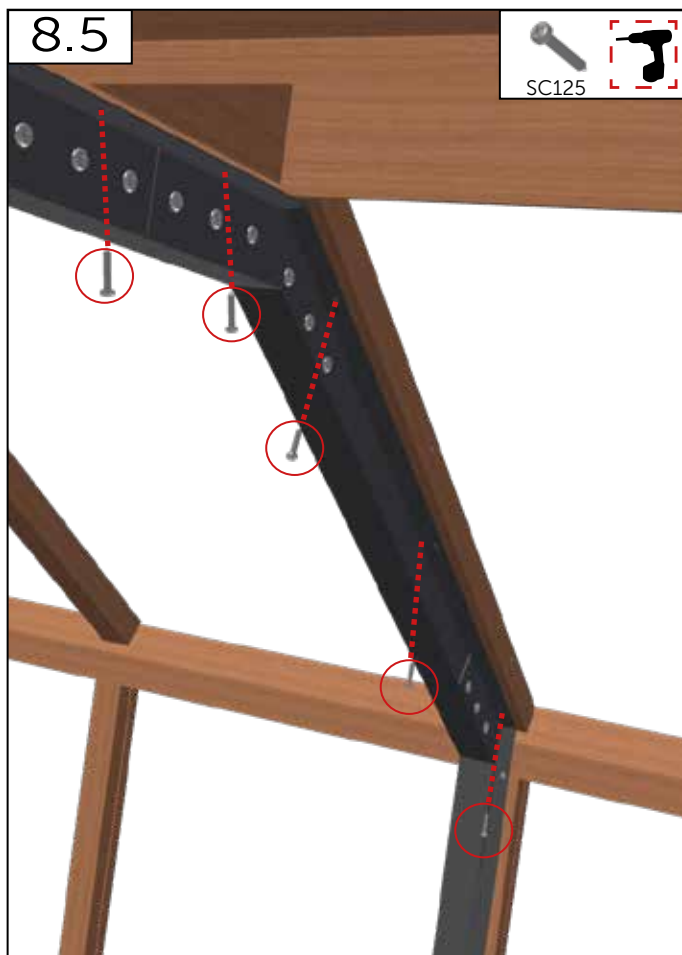
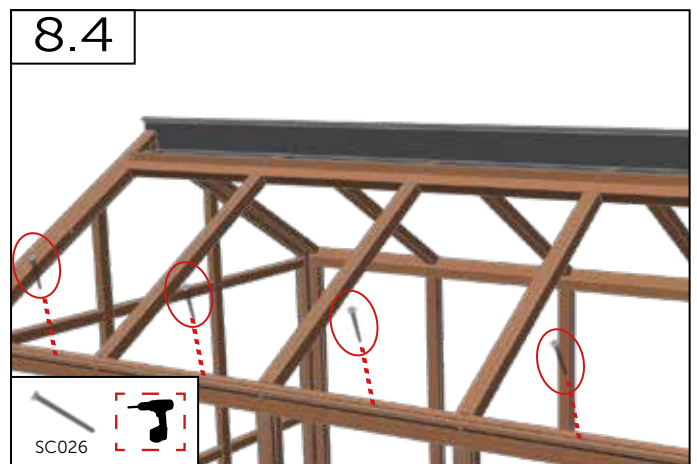
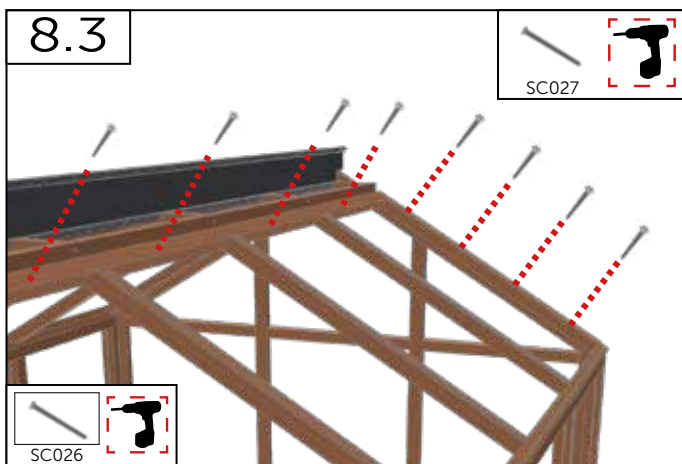
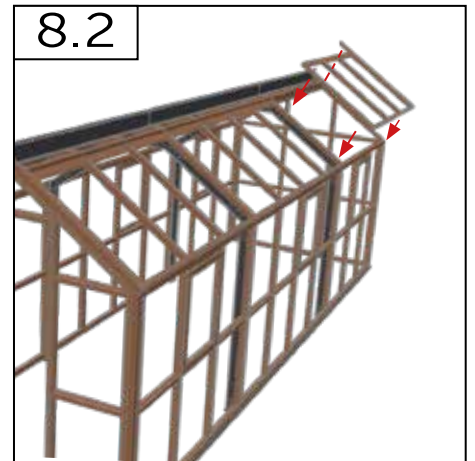
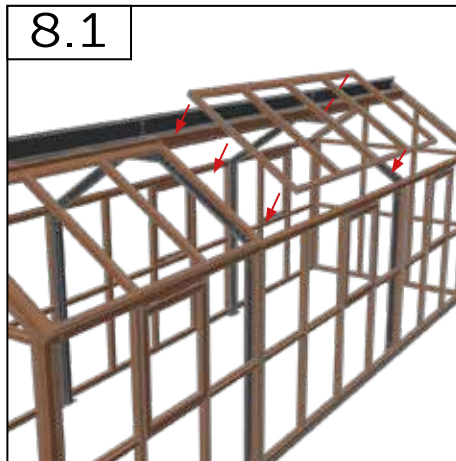
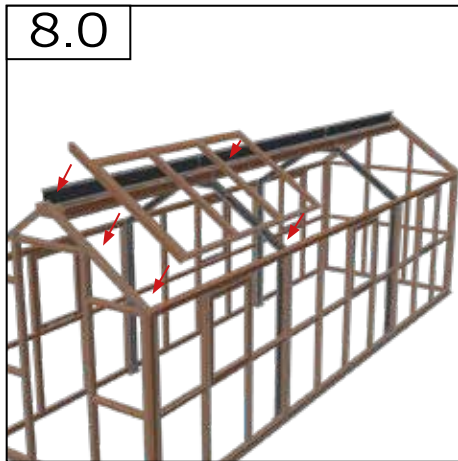

# (Extension) Roof - Tag - Dach - Tak - Toit - Dak - Katto - Techo



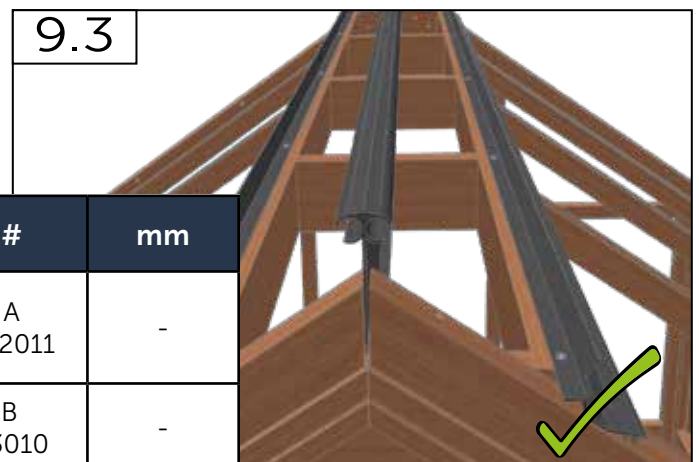
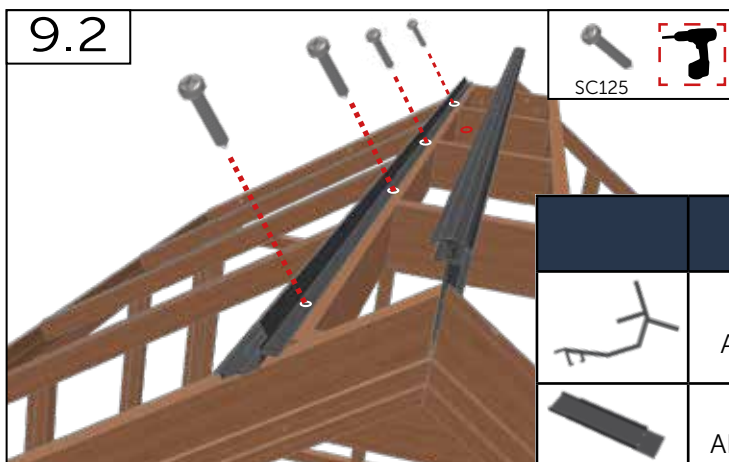
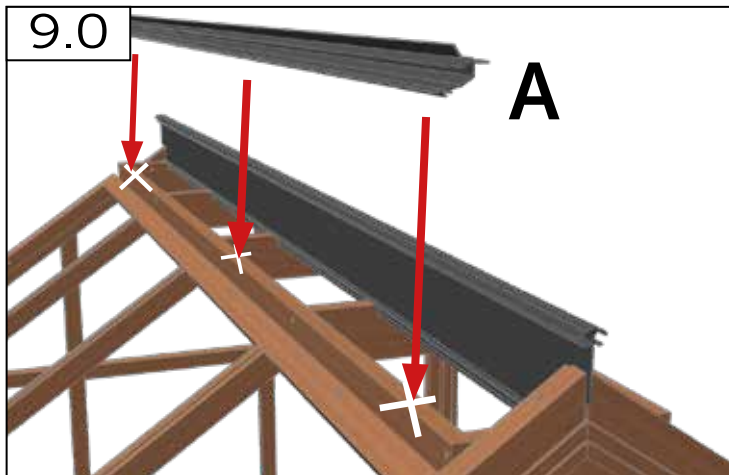

Trims - Trimmer - Trimmen - Garnitures - Versierungen - Trimmit  
 - Wykończenia - dornos



	#	mm
	A AL2011	-
	B AL3010	-
	SC125	4.2 x 25

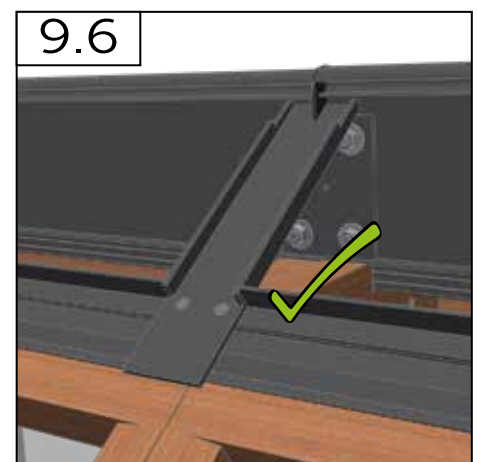
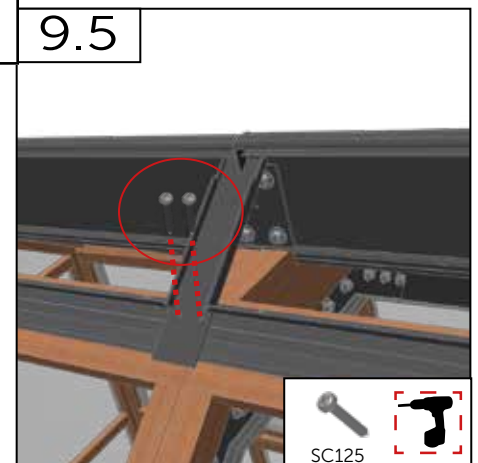
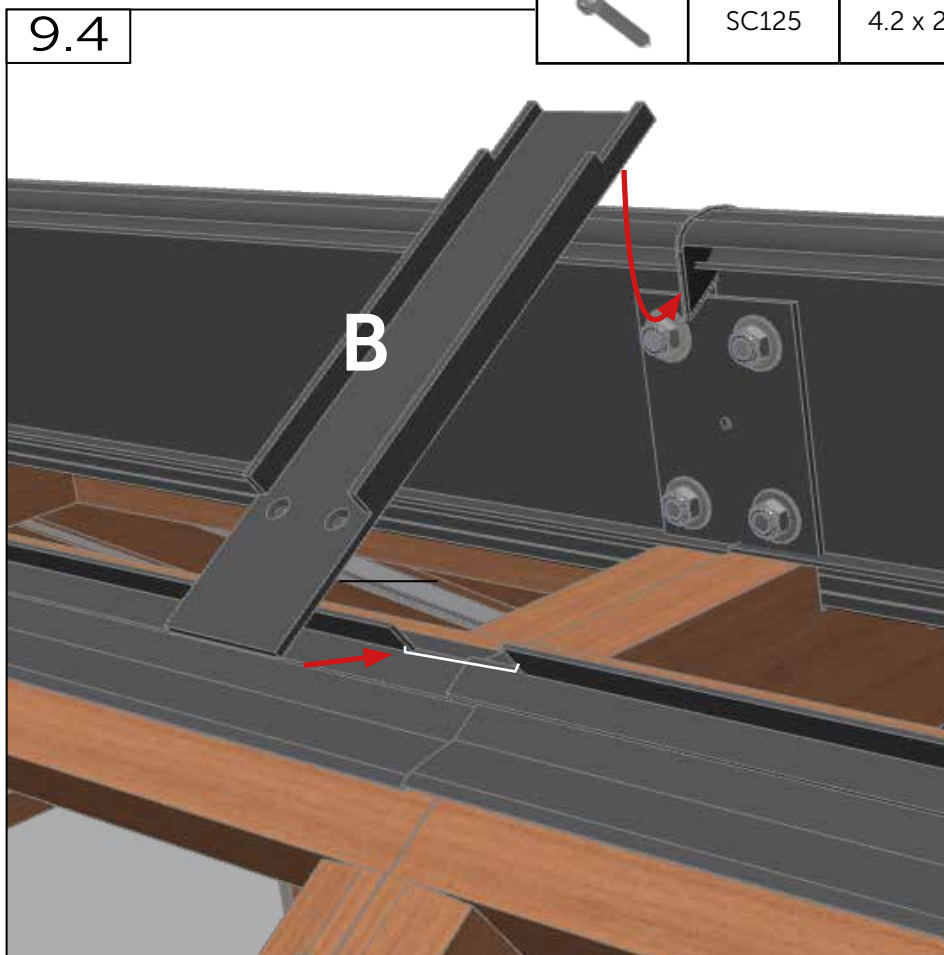

(Extension) Trims - Trimmer - Trimmen - Garnitures - Versierungen - Trimmit  
 - Wykończenia - dornos

	#	mm
	B AL2000	-
	AV001	-
	WA500	M6 x 16
	NU101	M6
	BL122	M6 x 16
	SC125	4.2 x 25

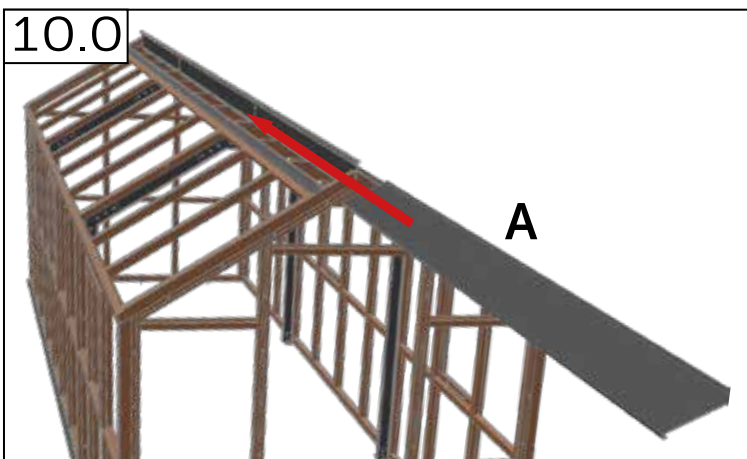
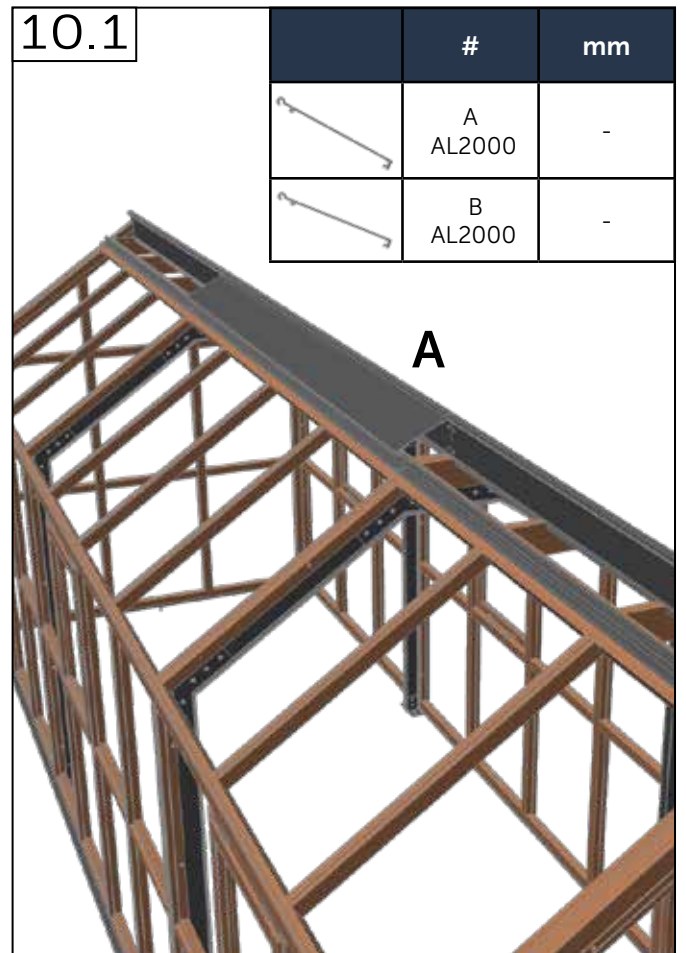
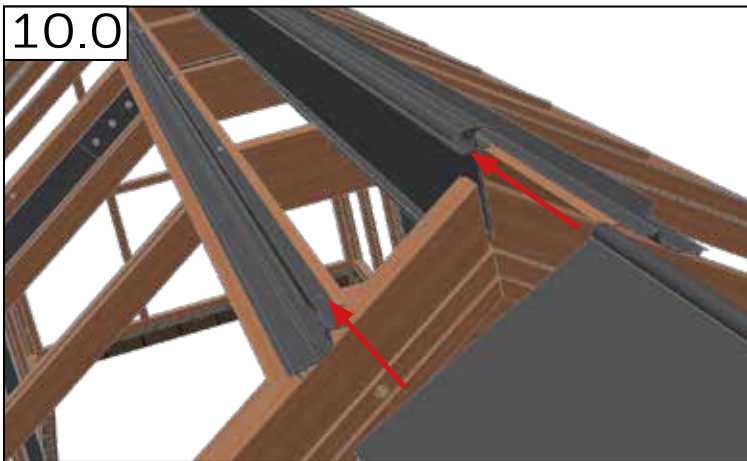
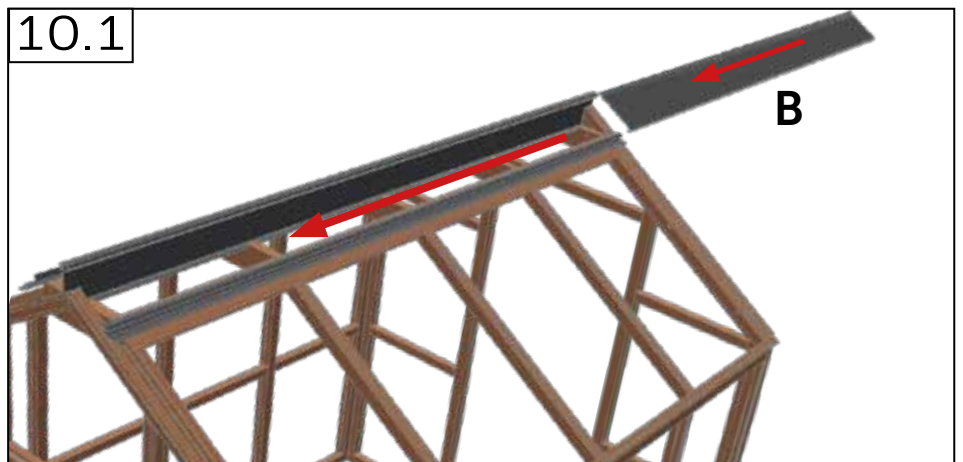
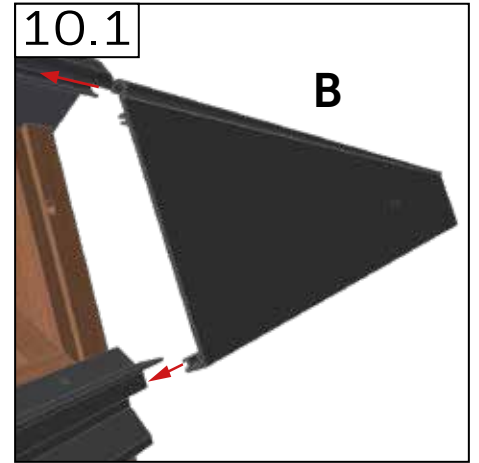
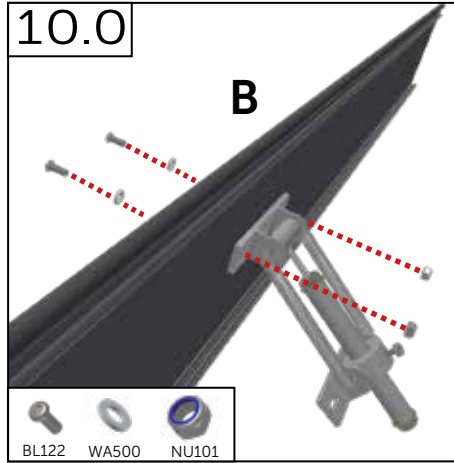



10.2

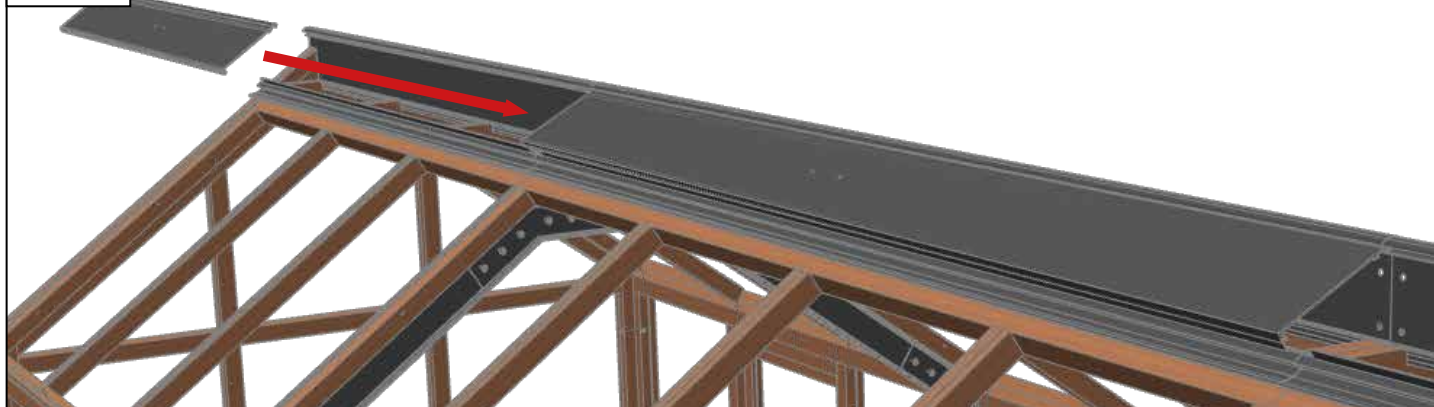

10.3

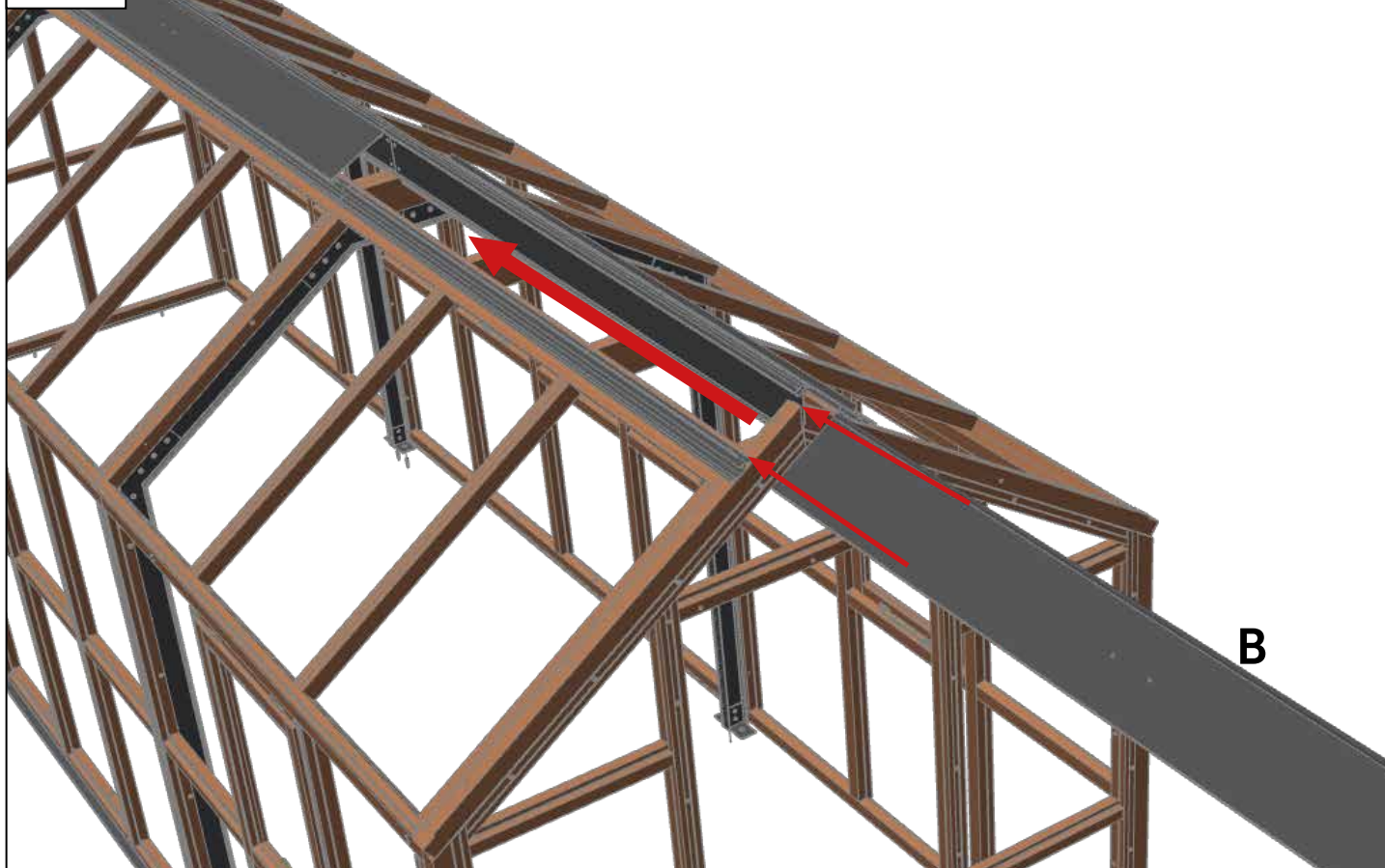

10.4

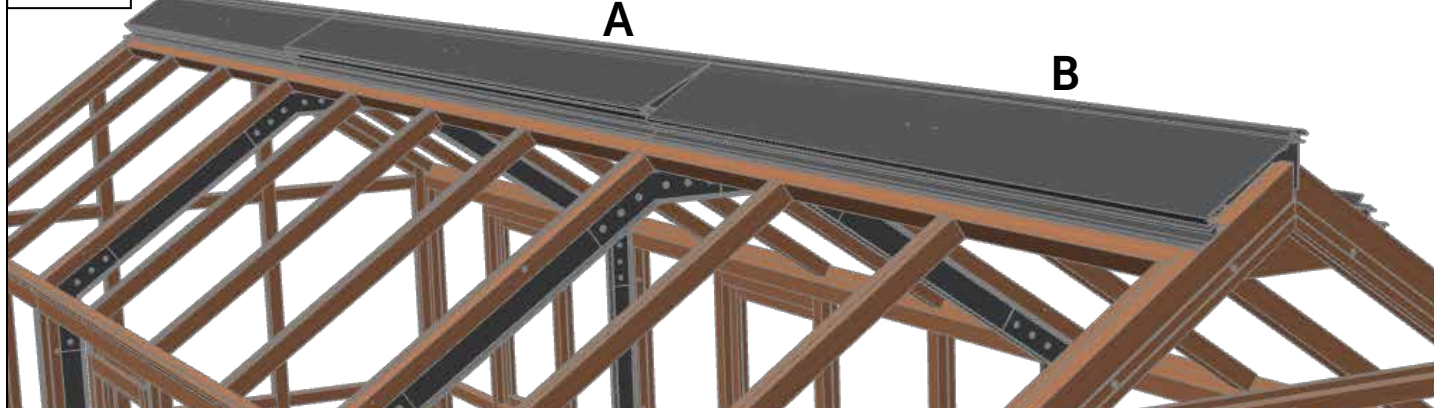

Trims - Trimmer - Trimmen - Garnitures - Versierungen - Trimmit  
 - Wykończenia - dornos

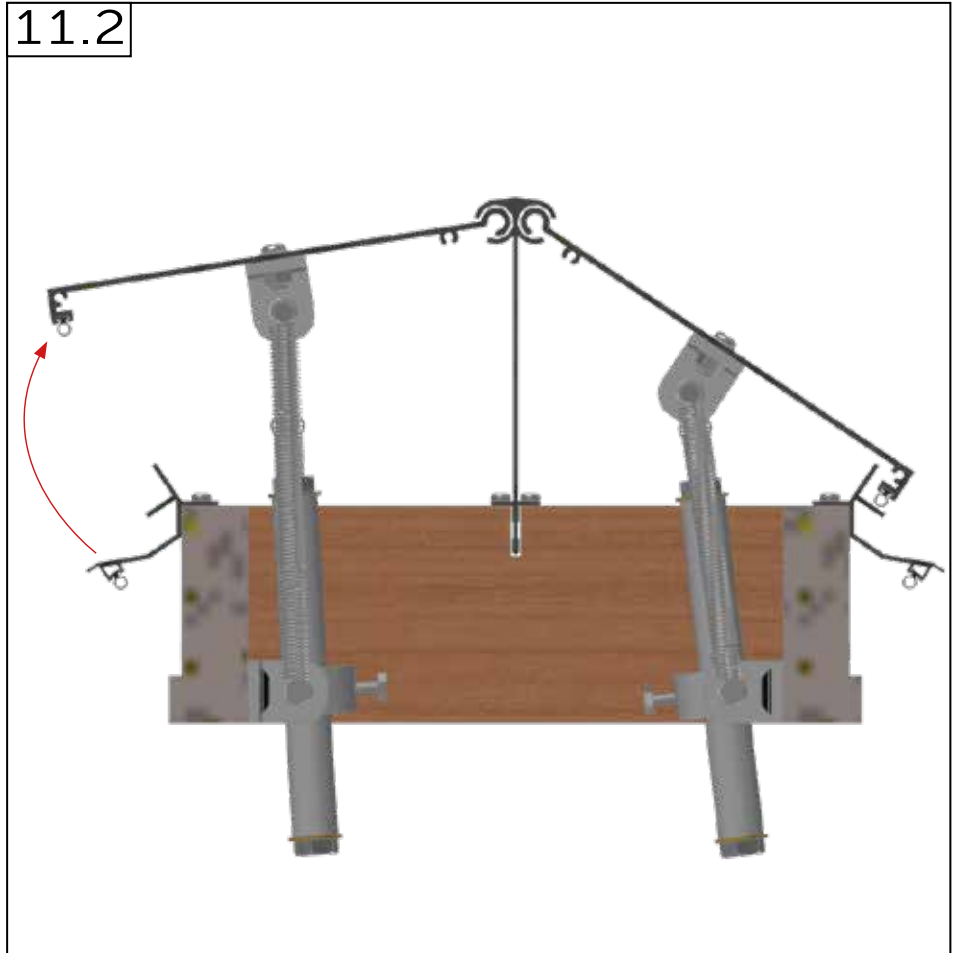
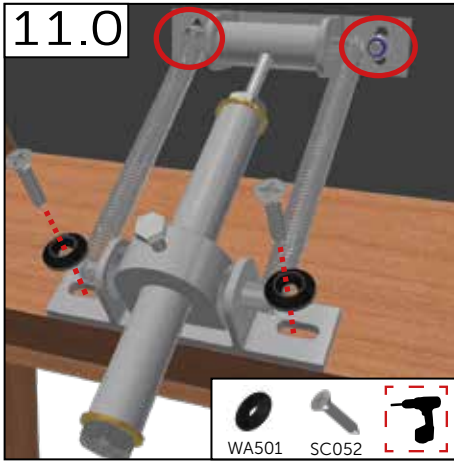



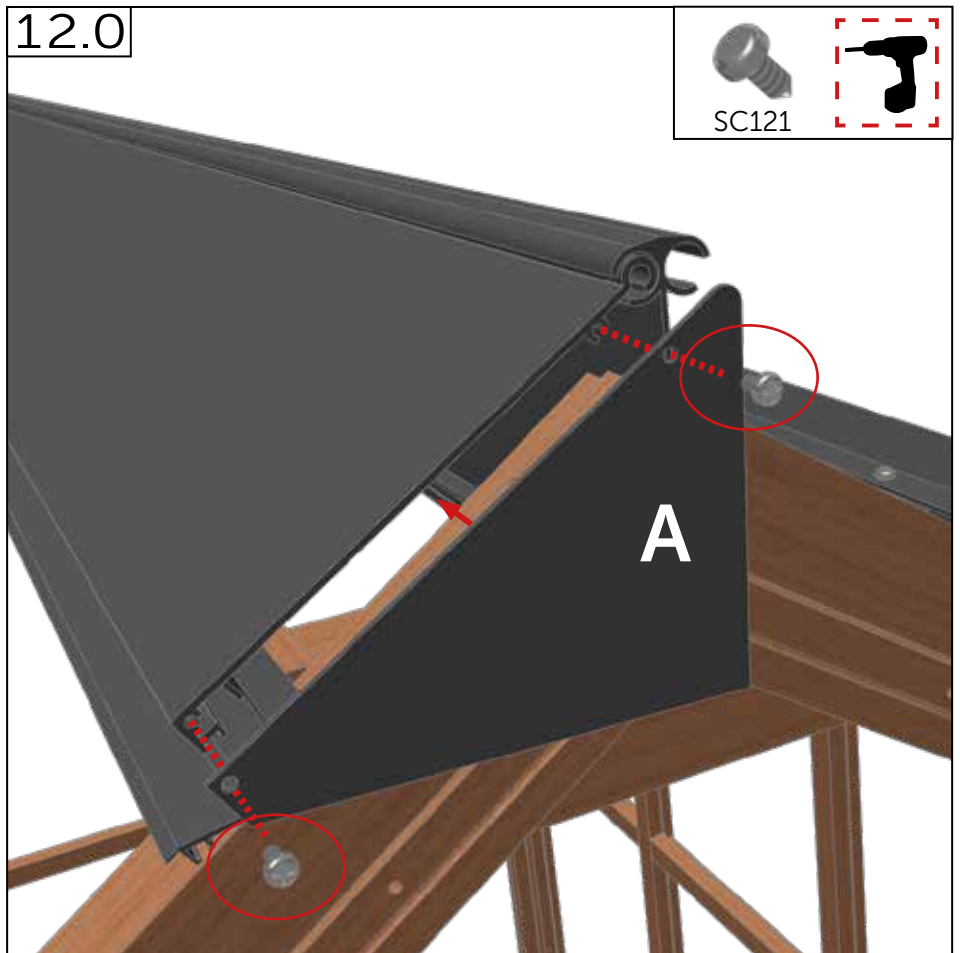



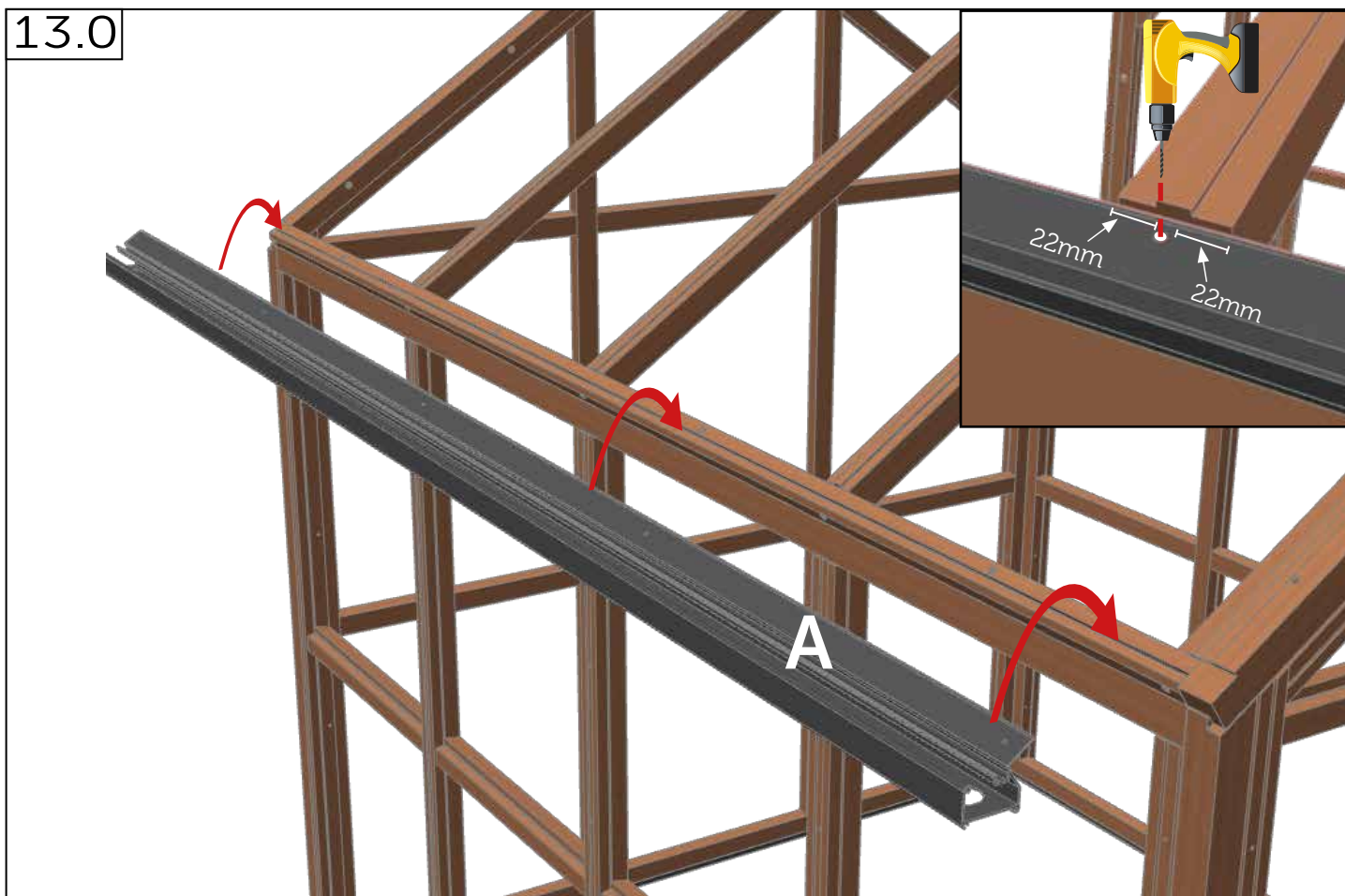

	AV001	-
	SC052	4.8 x 25
	WA501	18 x 5.3
	SC121	4.2 x 9.5
	A AL3016	-





13.0



	#	mm
	A AL2008	-
	PT200	MALE FEMALE
	SC125	4.2 x 25
	SC121	4.2 x 9.5
	B AL3003	-
	C AL3051	-
	PT204	-

13.1

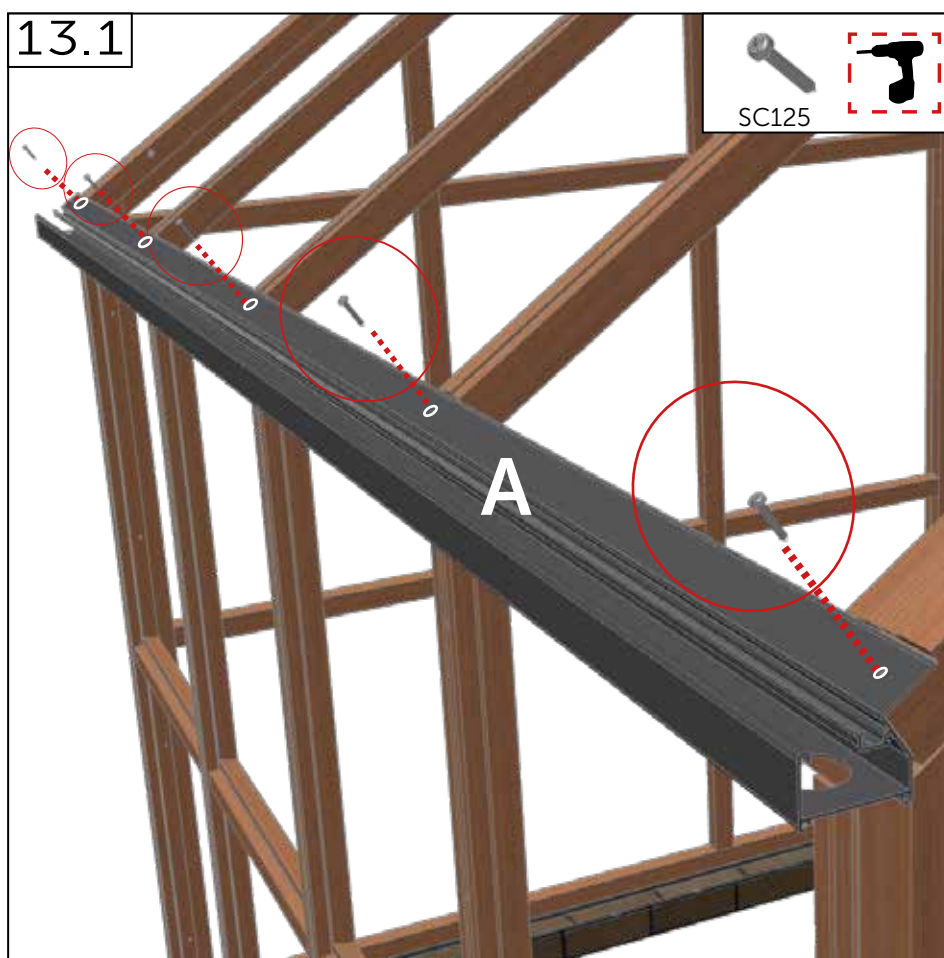

13.2

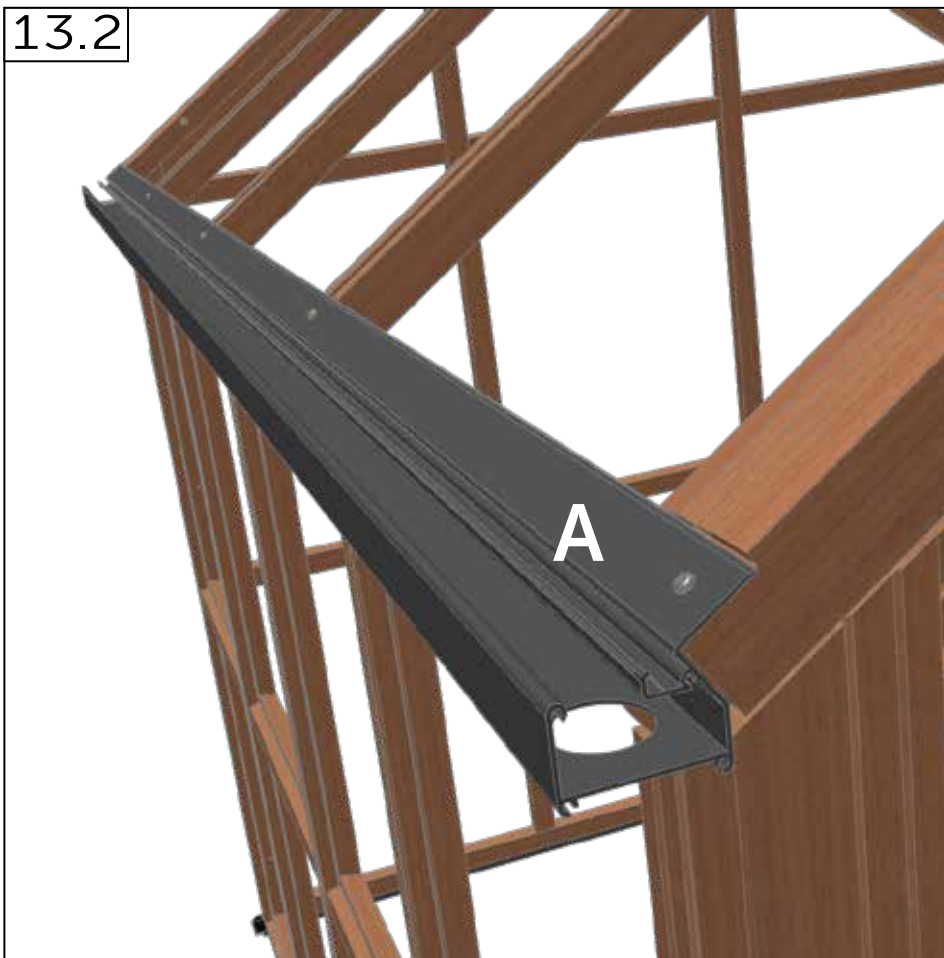

13.3

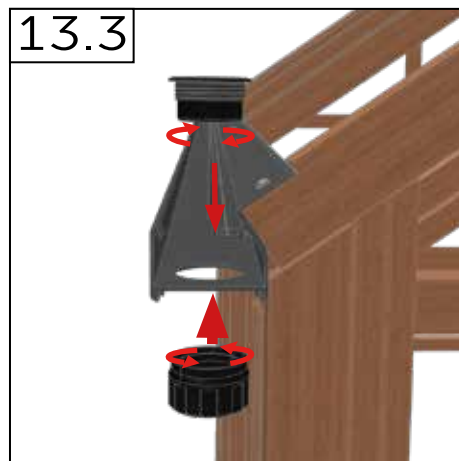

13.3

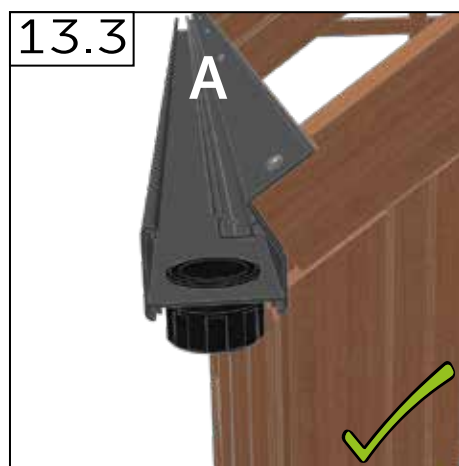

13.4

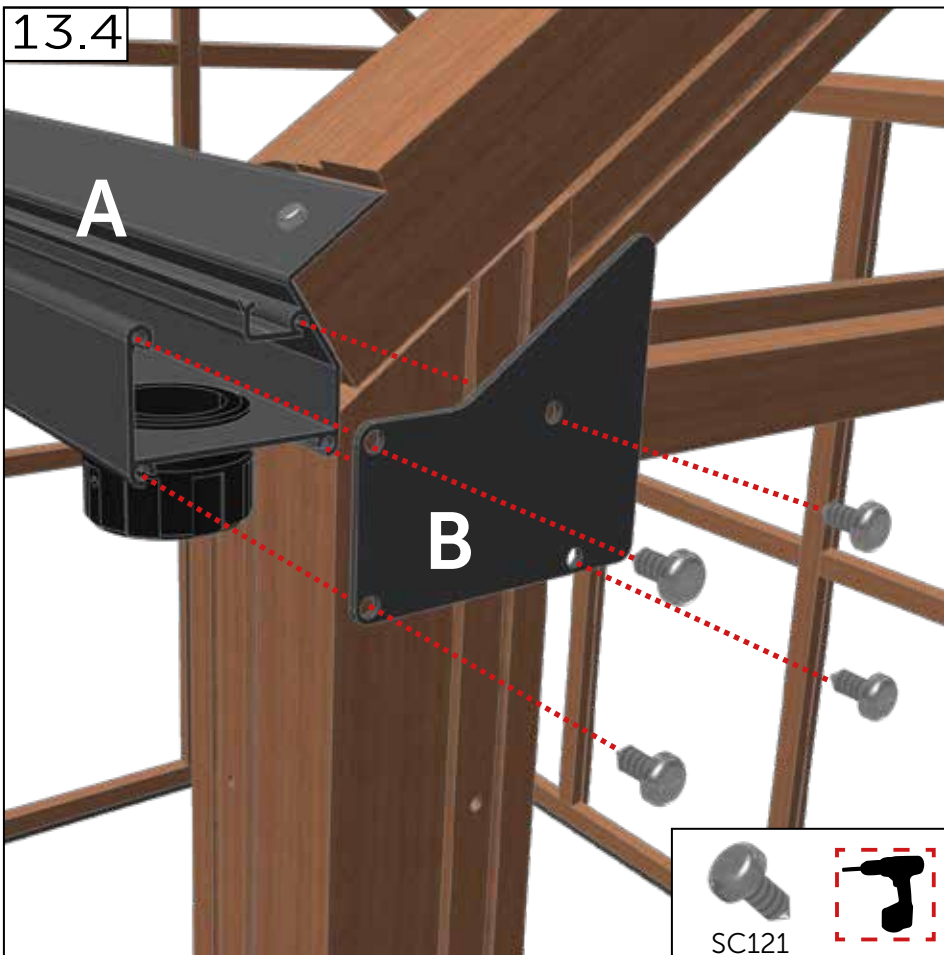

13.5

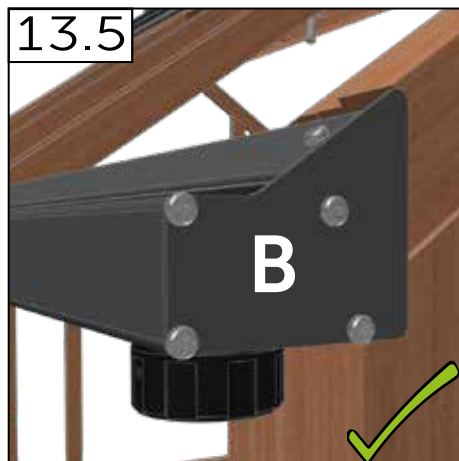



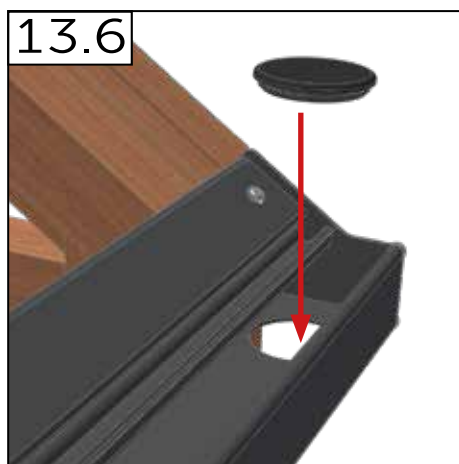

13.6



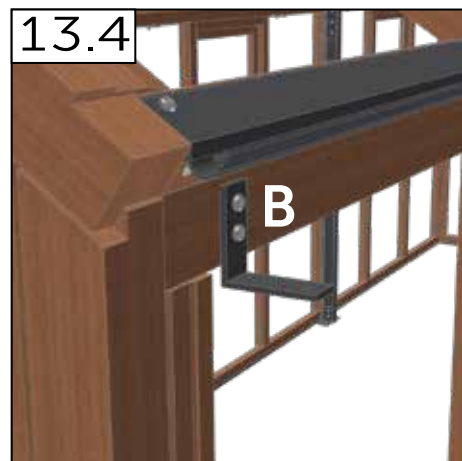
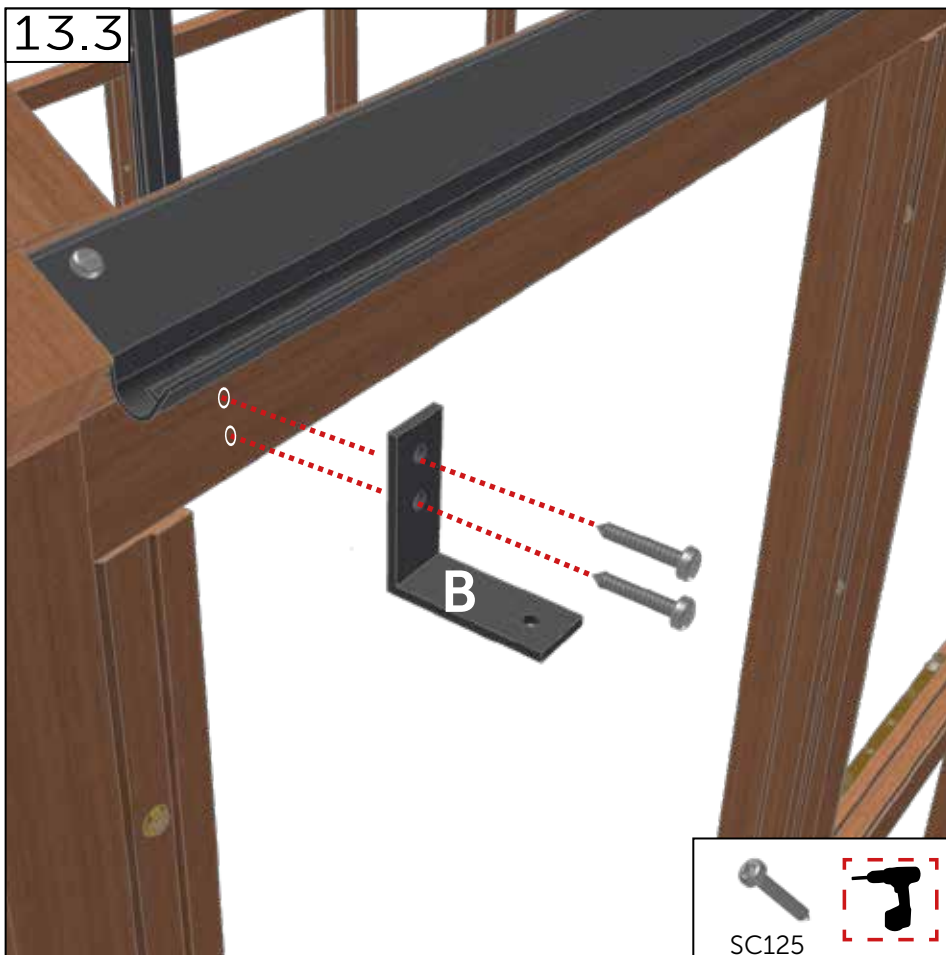
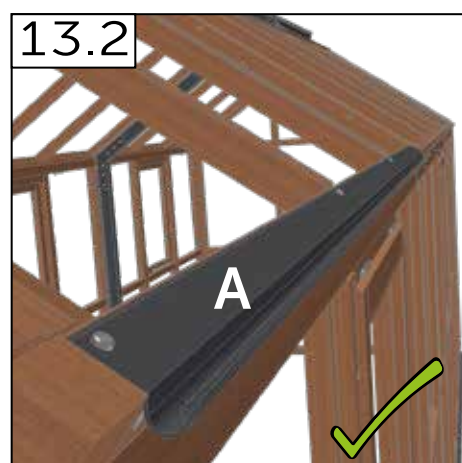
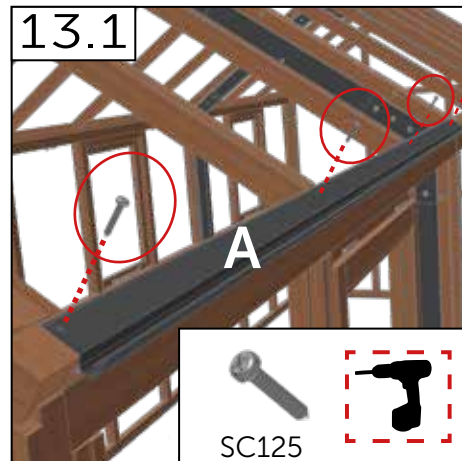
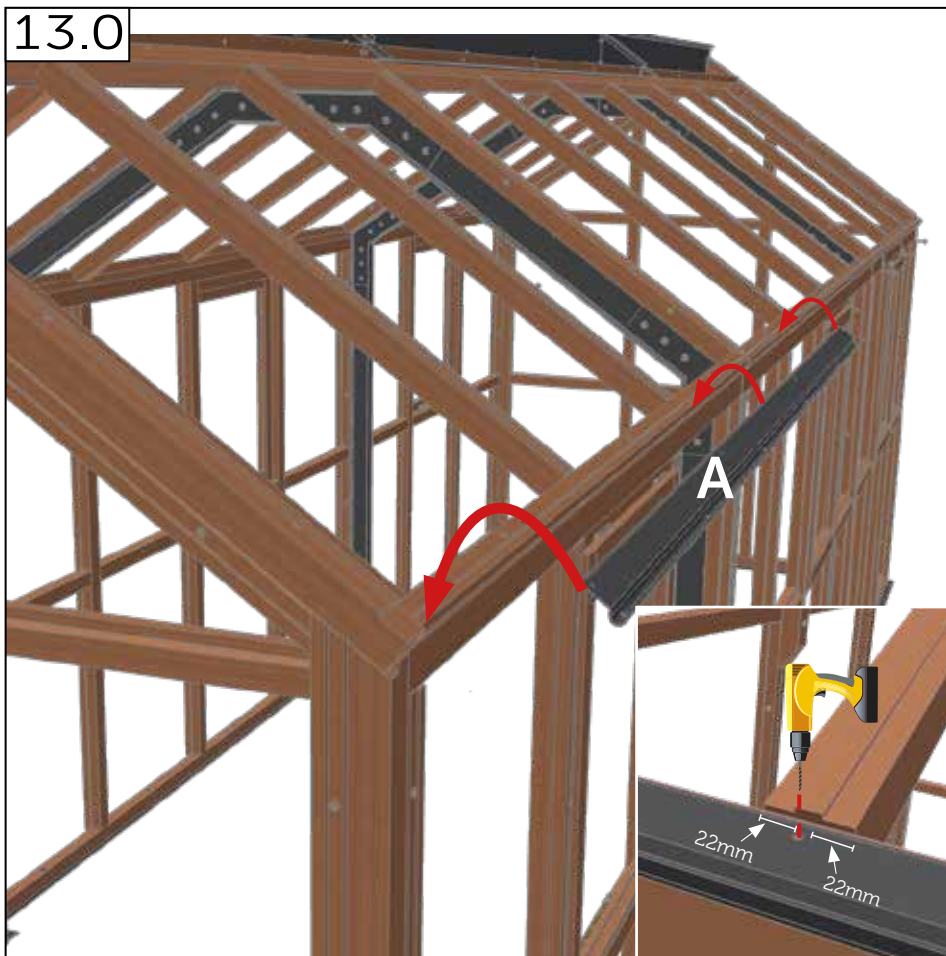









(Extension) Trims - Trimmer - Trimmen - Garnitures - Versierungen - Trimmit  
 - Wykończenia - dornos



	#	mm
	A AL2022	-
	SC125	4.2 x 25
	B AL3051	-

(Extension) Trims - Trimmer - Trimmen - Garnitures - Versierungen - Trimmit  
- Wykończenia - dornos

	#	mm
	A AL2014	-
	B AL2014	-
	C AL3018	-
	PT200	MALE FEMALE
	BL122	M6 x 16
	WA500	M6 x 16
	NU101	M6
	Silicone	-
	PT204	-

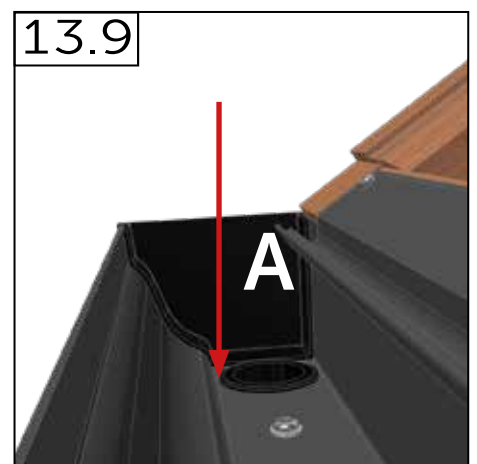
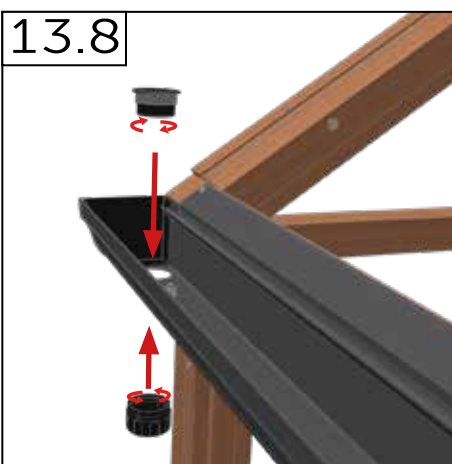
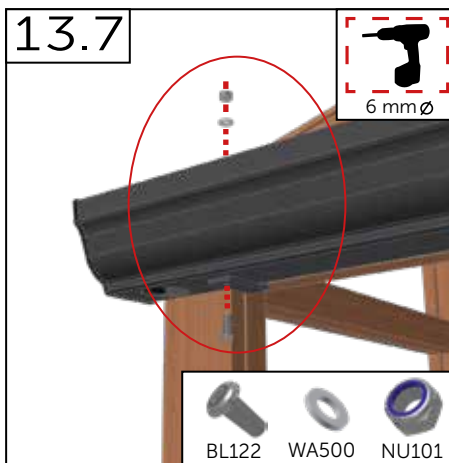
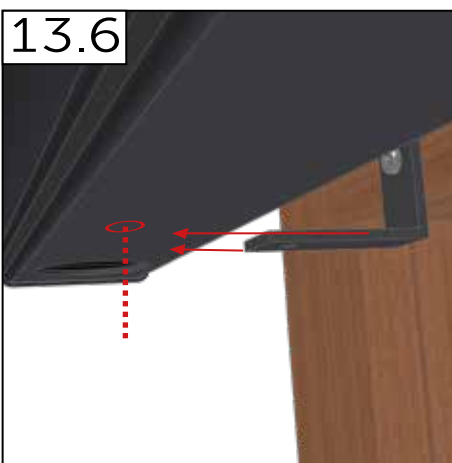
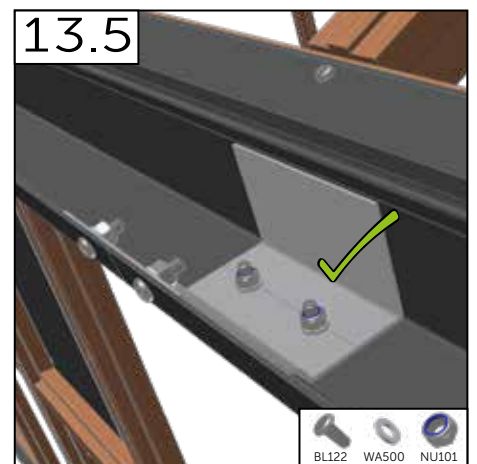
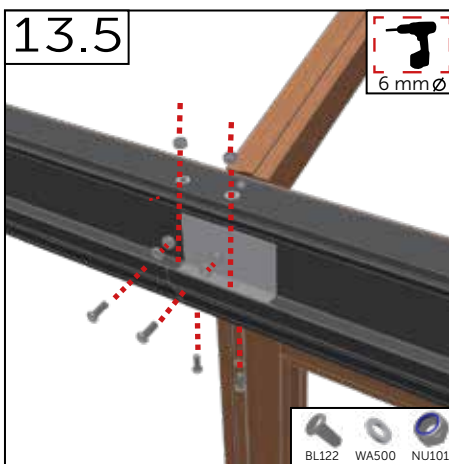
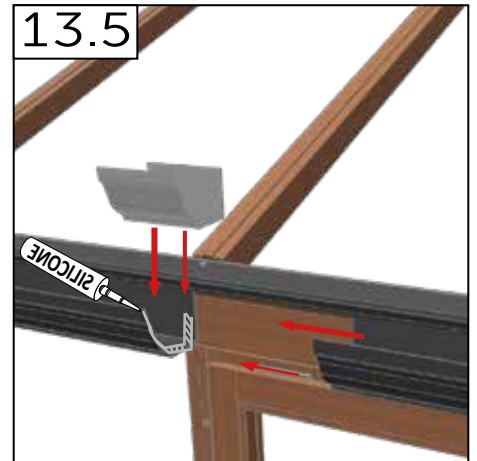
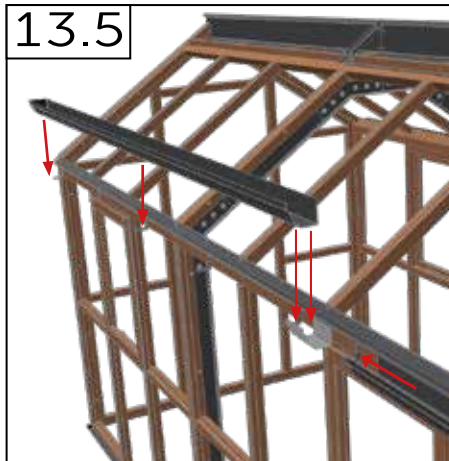



Securing - Sikring - Sicherung - Säkra - Sécurisation - Beveiligen  
 - Zabezpieczanie - Sikring - Asegurar

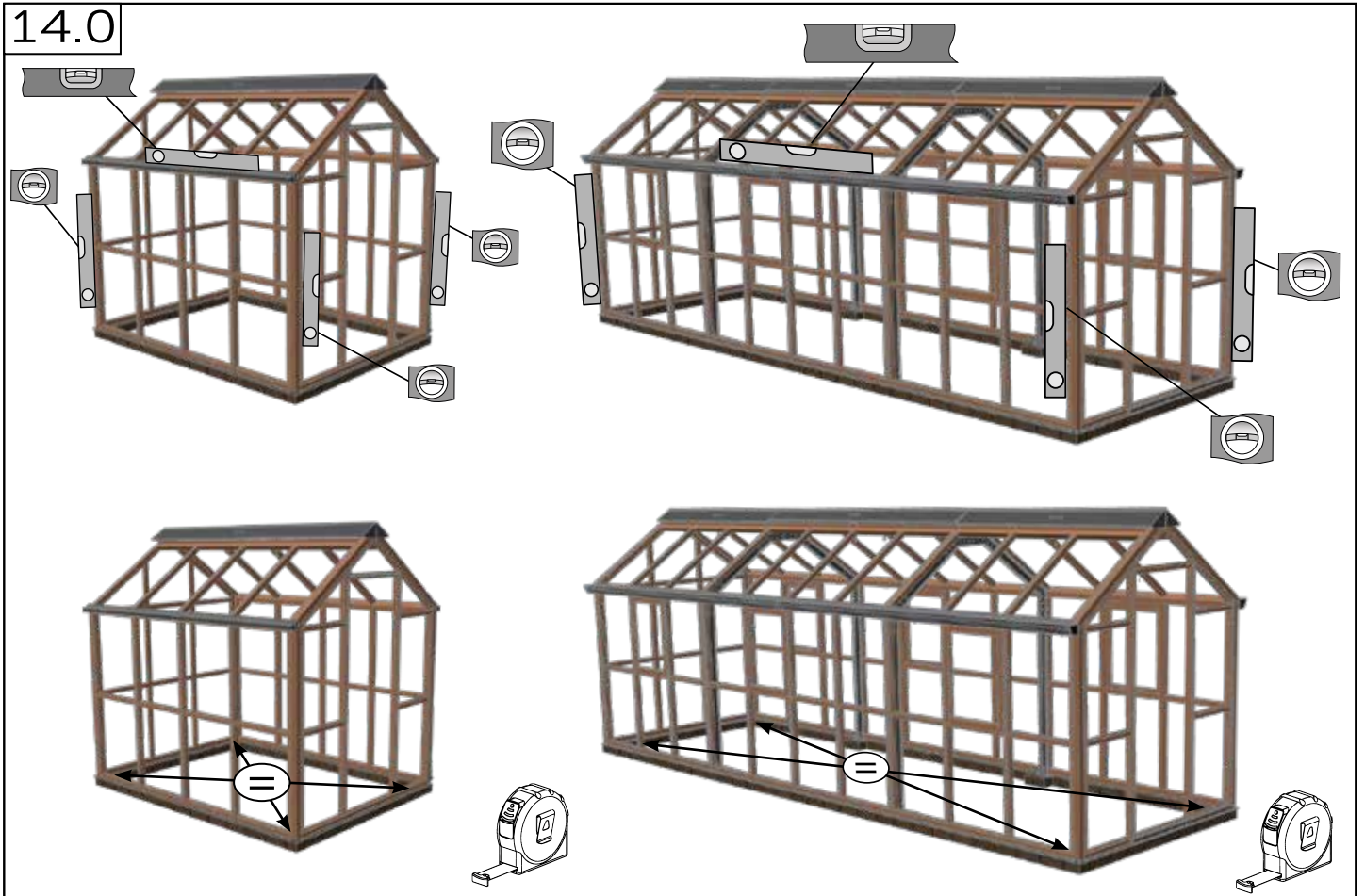

	#	mm
	SC058	4.8 x 100
	WA501	18 x 53
	FX200	8 x 40

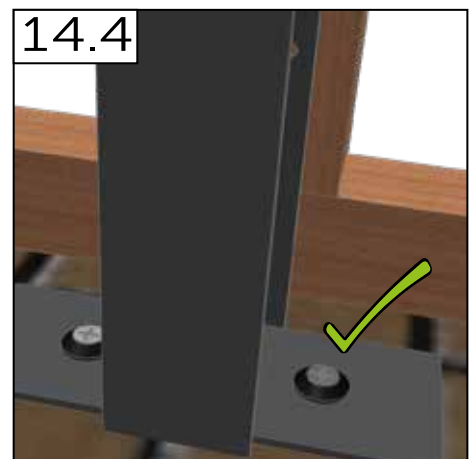
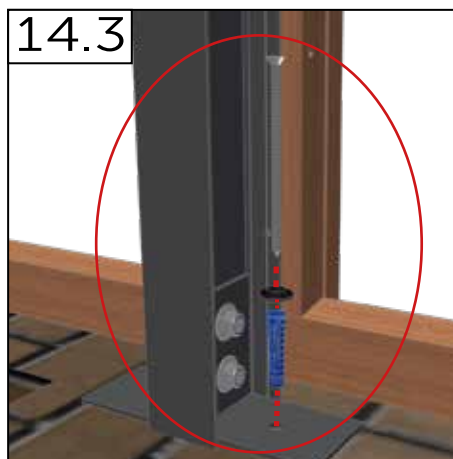
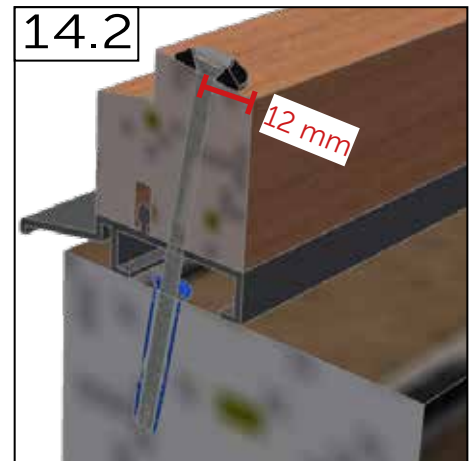
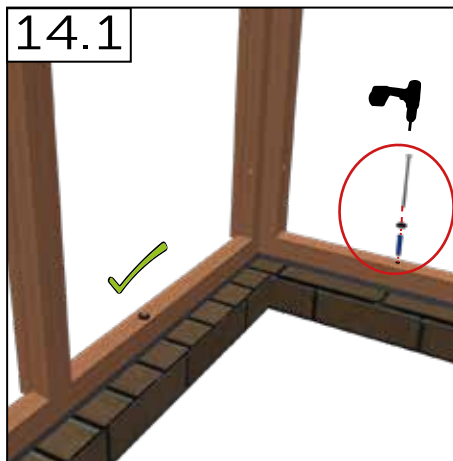

15.0

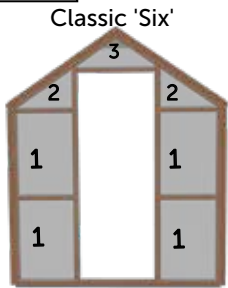

- 1. 0488 x 0717
- 2. 0488 x 0349
- 3. 0660 x 0256

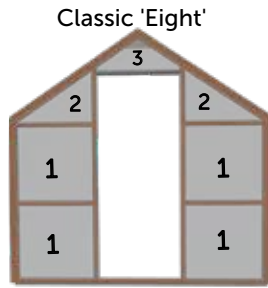

- 1. 0717 x 0717
- 2. 0717 x 0506
- 3. 0775 x 0312

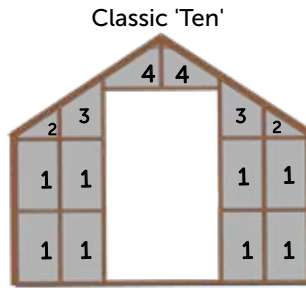

- 1. 0401 x 0717
- 2. 0401 x 0290
- 3. 0402 x 0584
- 4. 0545 x 0460

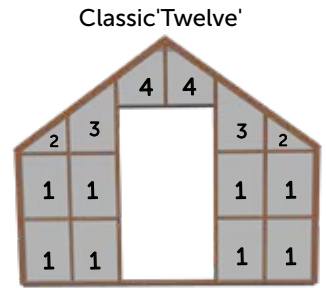

- 1. 0545 x 0717
- 2. 0545 x 0388
- 3. 0545 x 0780
- 4. 0545 x 0659

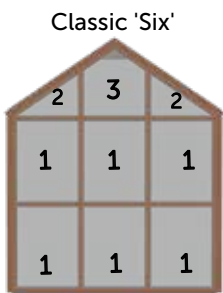

- 1. 0545 x 0717
- 2. 0545 x 0388
- 3. 0545 x 0594

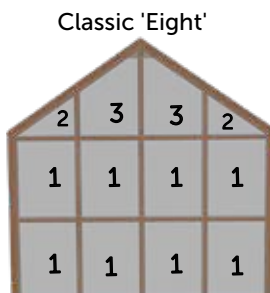

- 1. 0545 x 0717
- 2. 0545 x 0388
- 3. 0545 x 0780

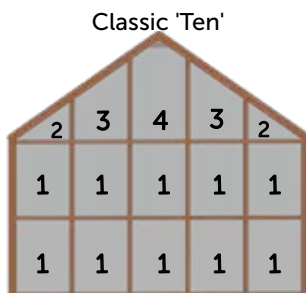

- 1. 0545 x 0717
- 2. 0545 x 0388
- 3. 0545 x 0780
- 4. 0545 x 0986

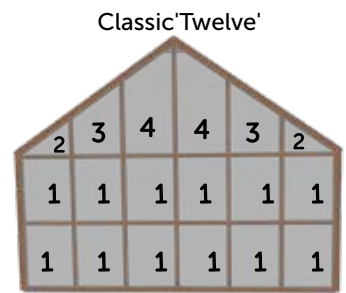

- 1. 0545 x 0717
- 2. 0545 x 0388
- 3. 0545 x 0780
- 4. 0545 x 1173

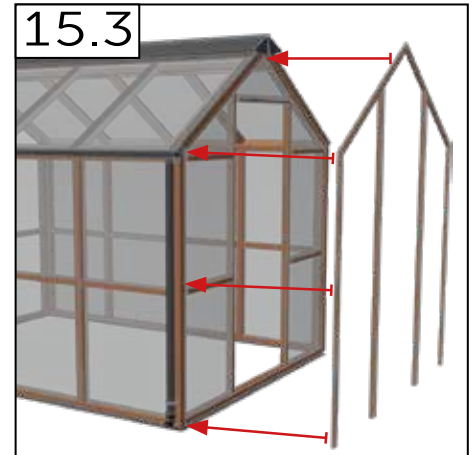
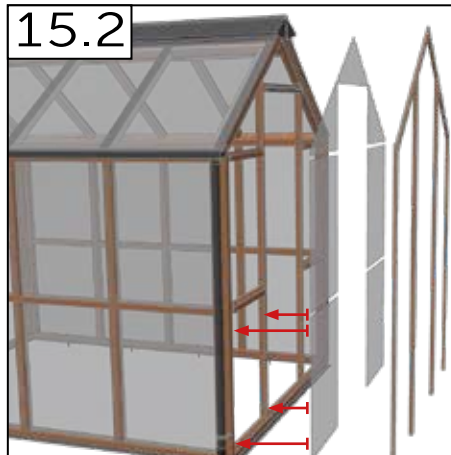
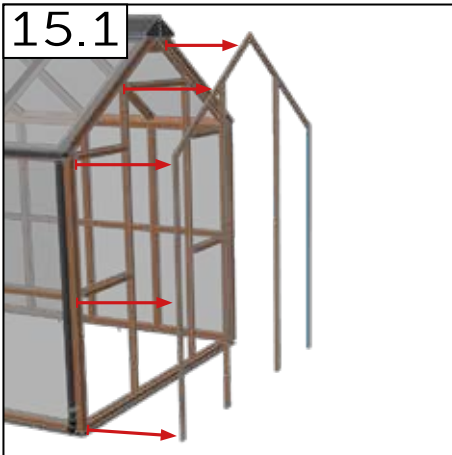

	#	mm
	GLASS	-
	A AL2009	-
	SC125	4.2 x 25
	SC305	3.5 x 32
	WA300	No. 6

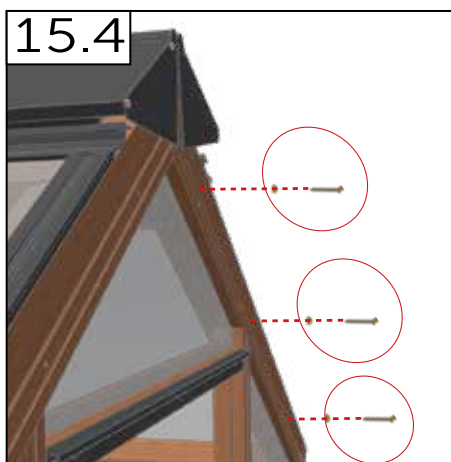

16.0

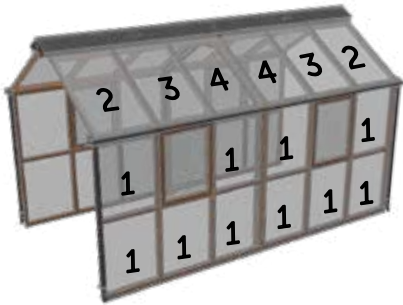

- Classic 'Six'**
1. 0545 x 0717
  2. 0589 x 0963
  3. 0555 x 0963
  4. 0570 x 0963

- Classic 'Eight'**
1. 0545 x 0717
  2. 0589 x 1310
  3. 0555 x 1310
  4. 0570 x 1310

- Classic 'Ten'**
1. 0545 x 0717
  2. 0589 x 1658
  3. 0555 x 1658
  4. 0570 x 1658

- Classic 'Twelve'**
1. 0545 x 0717
  2. 0589 x 2006
  3. 0555 x 2006
  4. 0570 x 2006

16.1

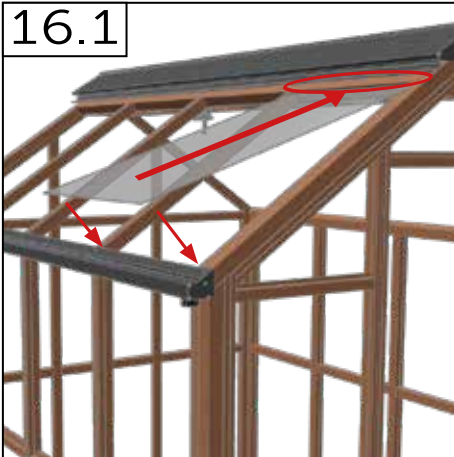

16.2



16.3

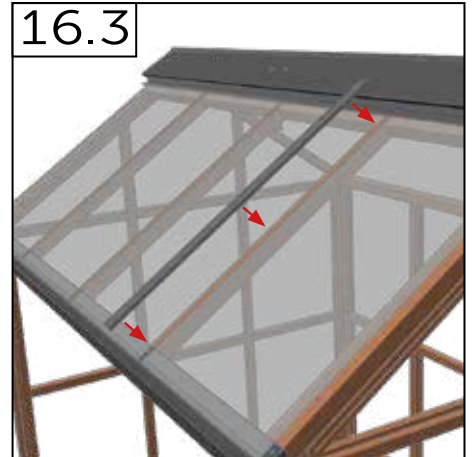

16.4

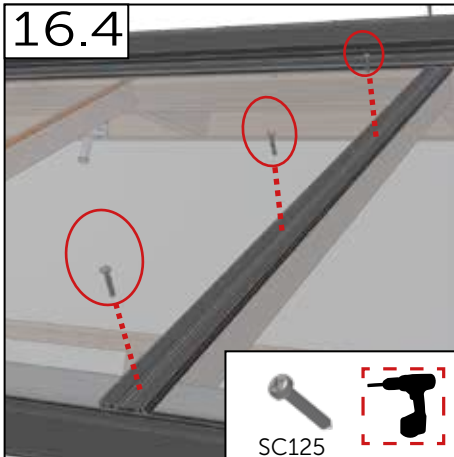

16.5

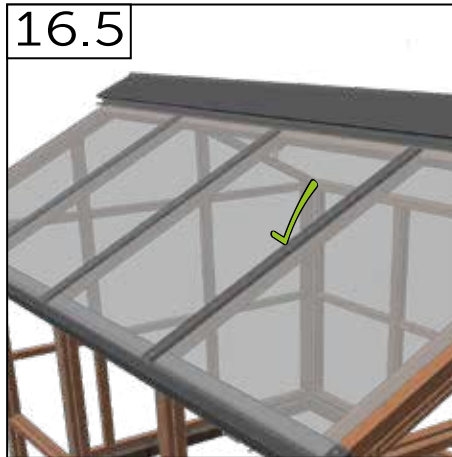

16.6

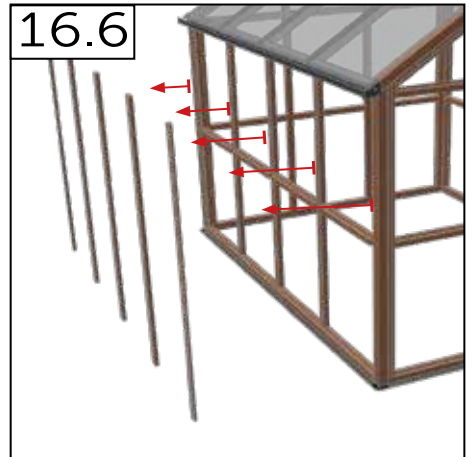

16.7

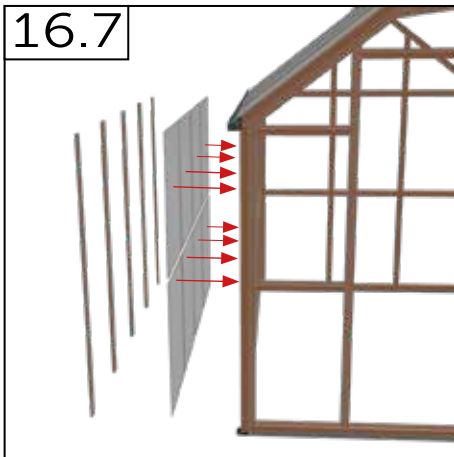

16.8

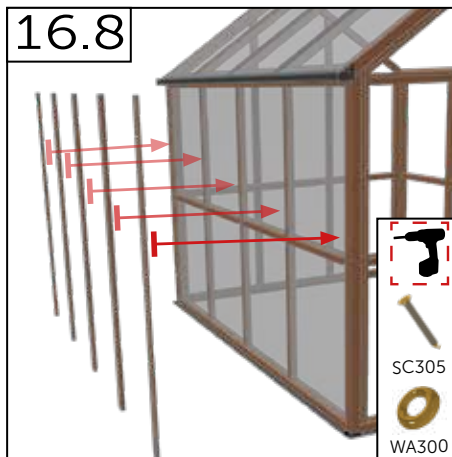

16.9

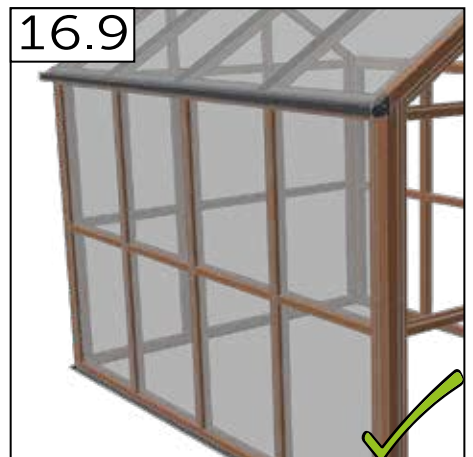



17.0

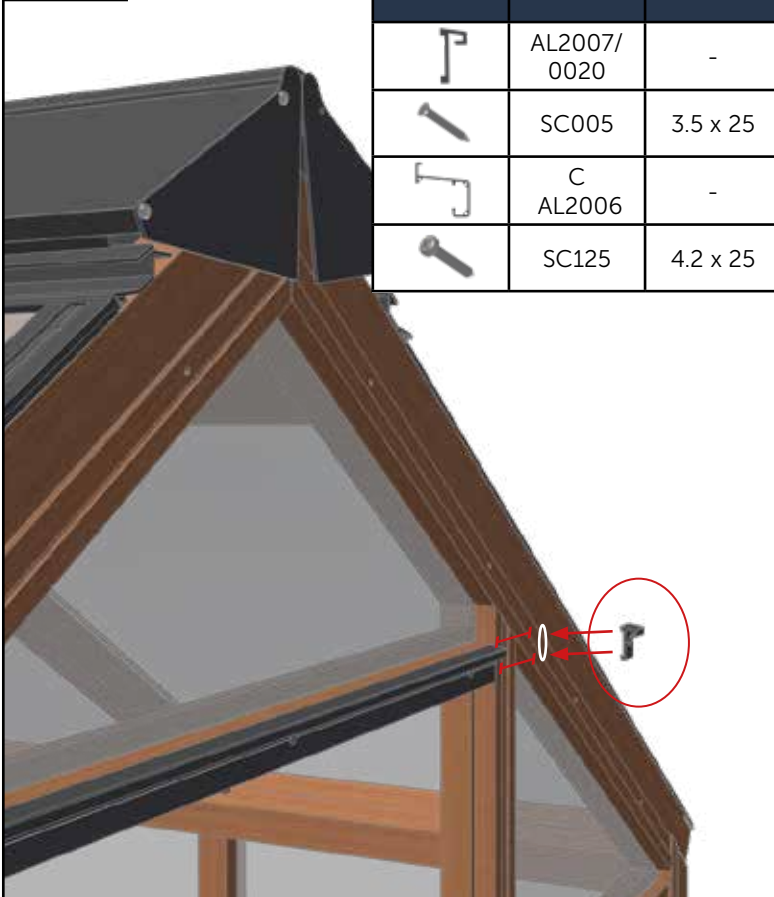

17.1

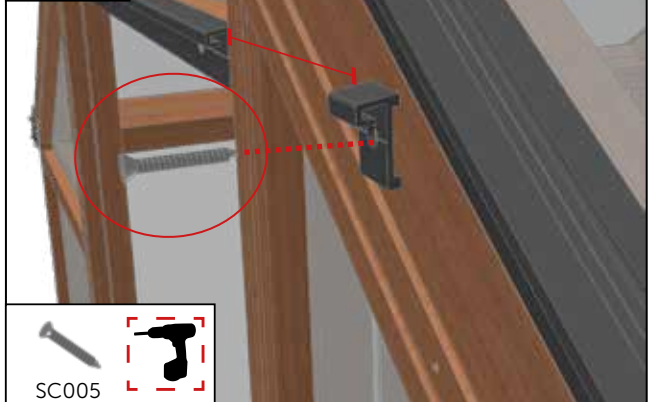

17.2



17.3

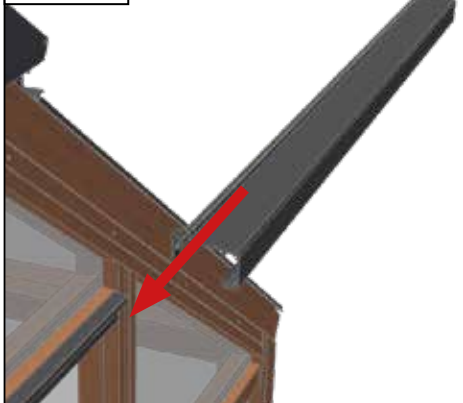

17.4

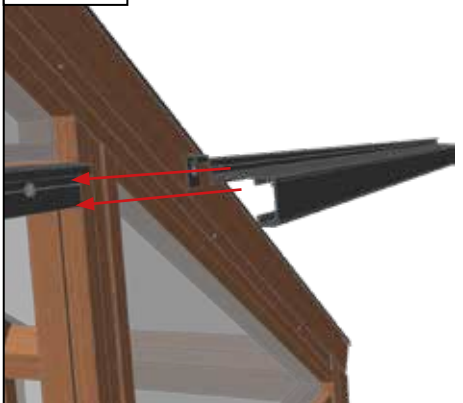

17.5

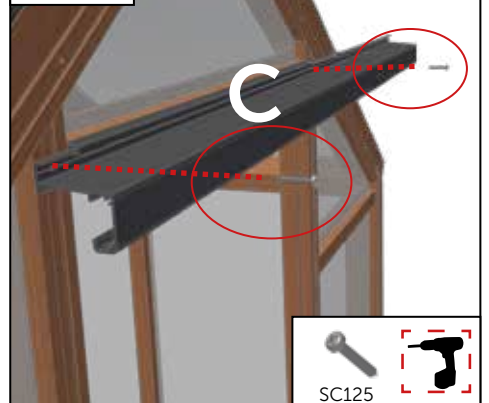

17.6

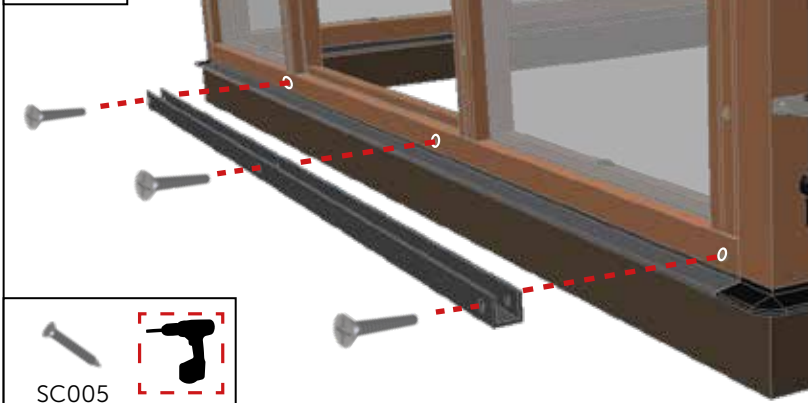

17.7

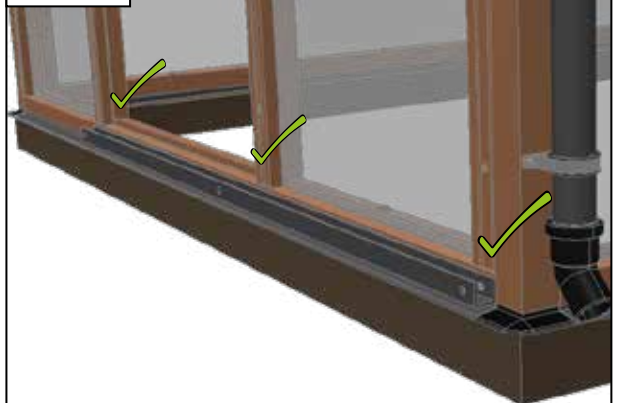

18.0

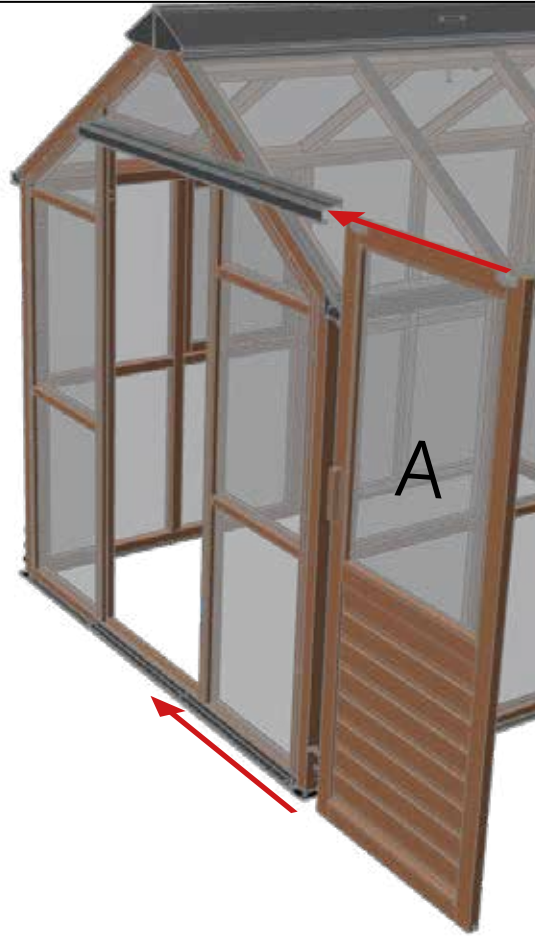

	#	mm
	A	-
	SC026	4.2 x 50
	W056-01	-
	B AL3098	-
	C AL3099	-
	SC125	4.2 x 25

18.1

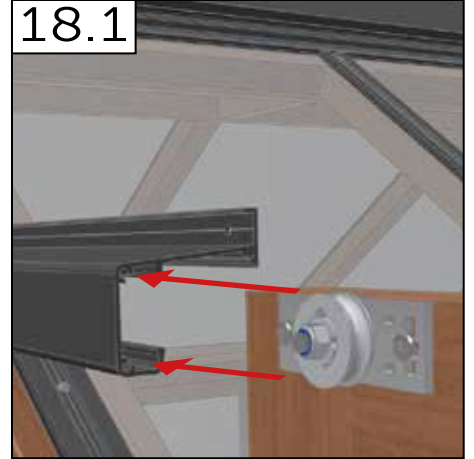

18.2

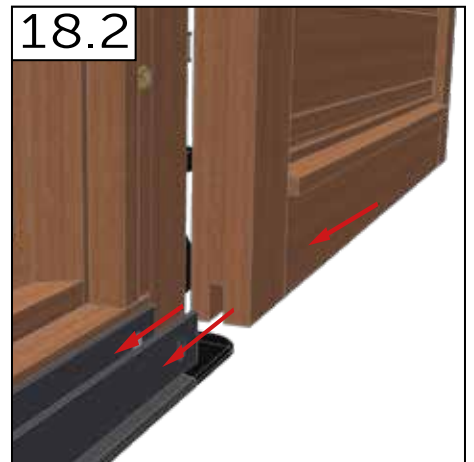

18.3

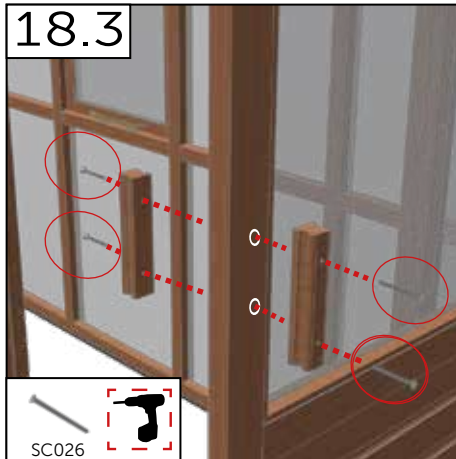

18.4

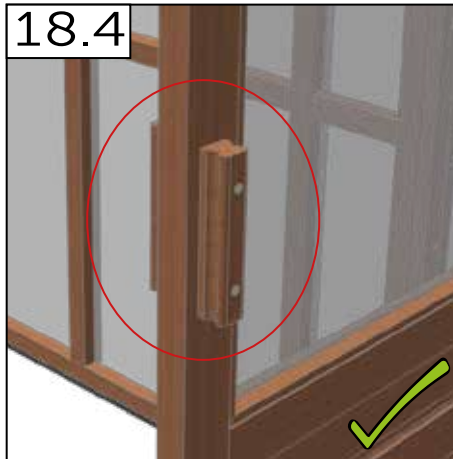

18.5



18.6

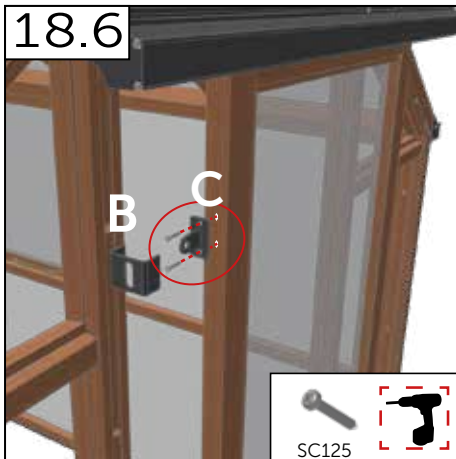



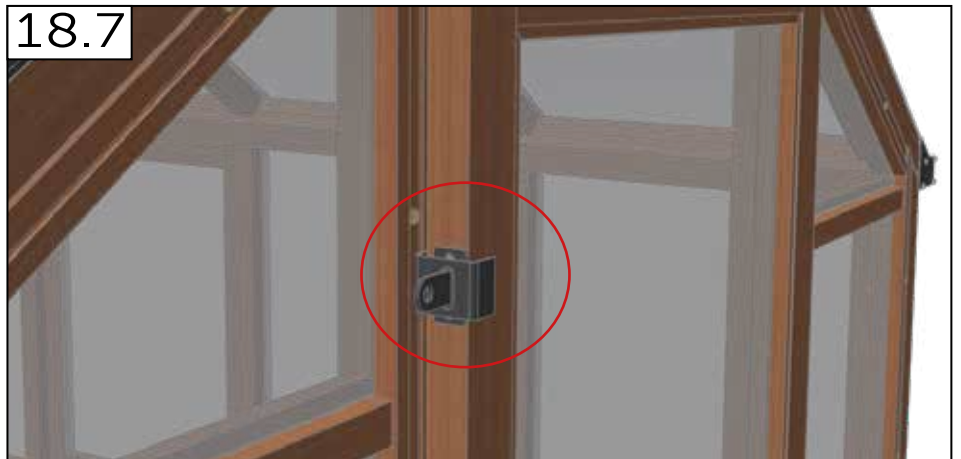

18.7





17.0

	#	mm
	AL2007 /0020	-
	SC005	3.5 x 25
	C AL2006	-
	SC125	4.2 x 25
	D AL2542	-

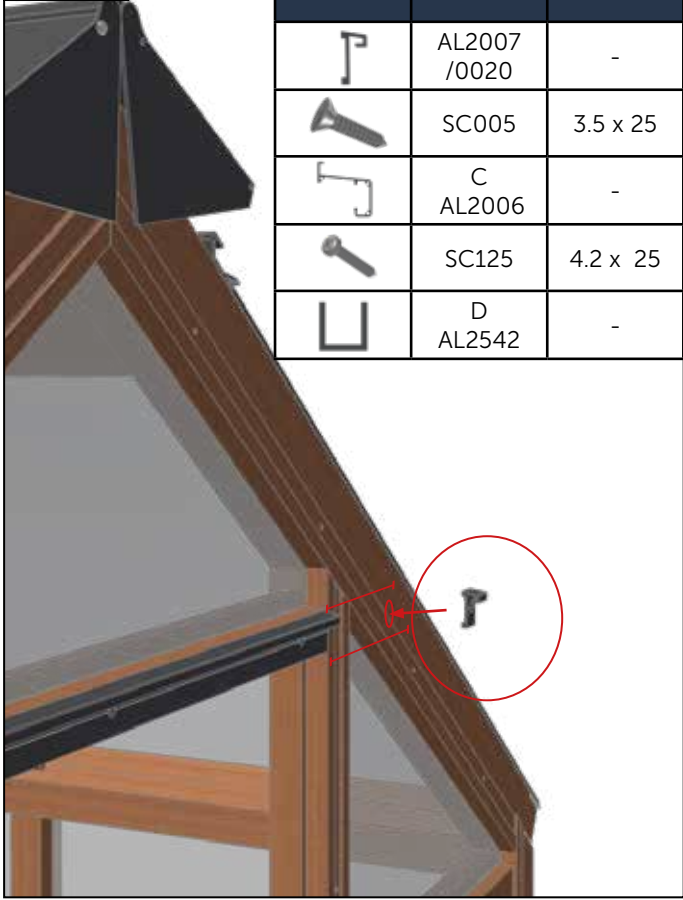

17.1

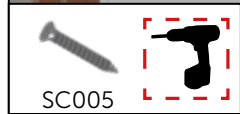
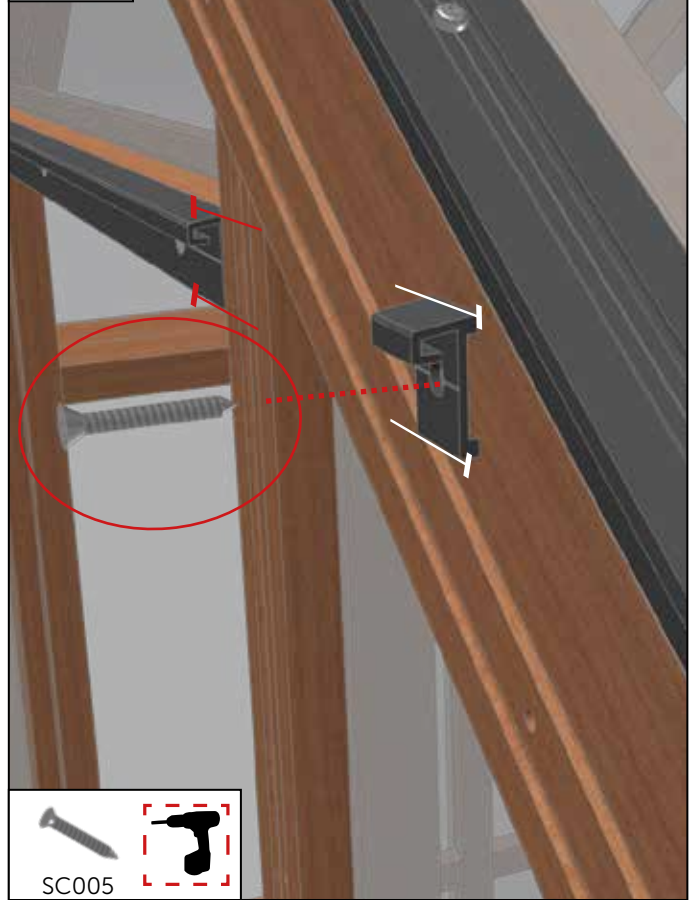

17.2

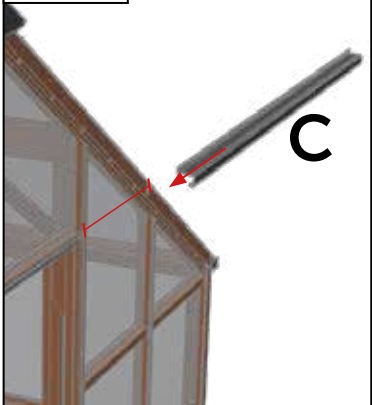

17.2

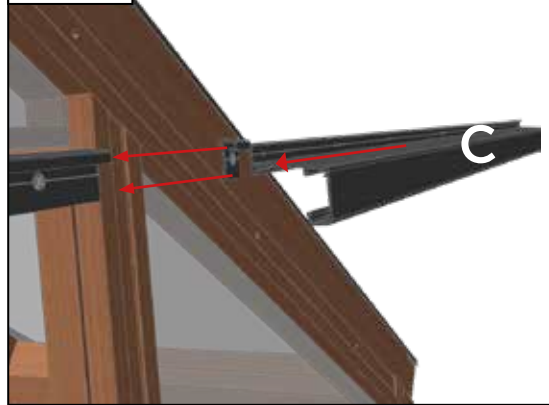

17.3

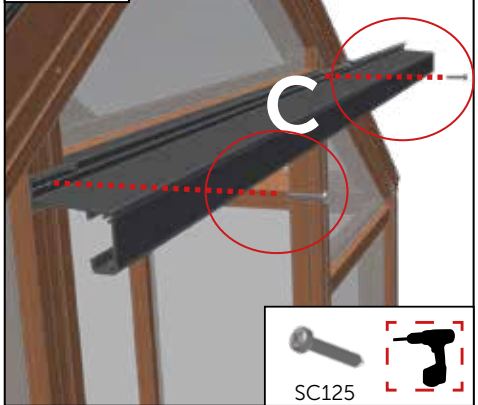

17.4

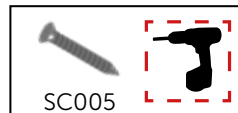
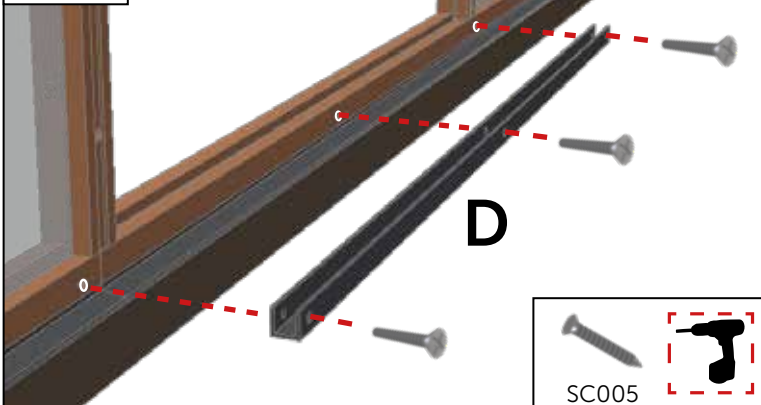

17.5

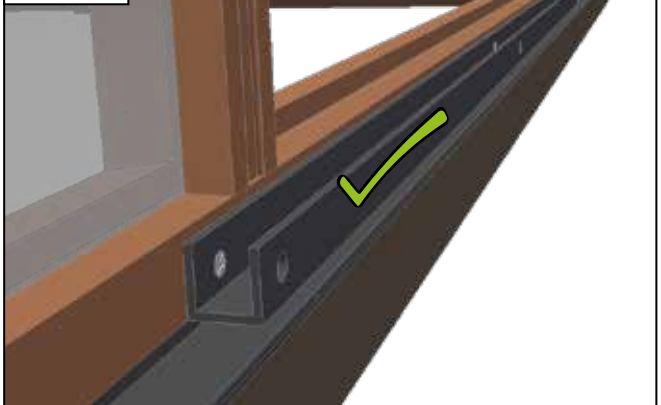

18.0

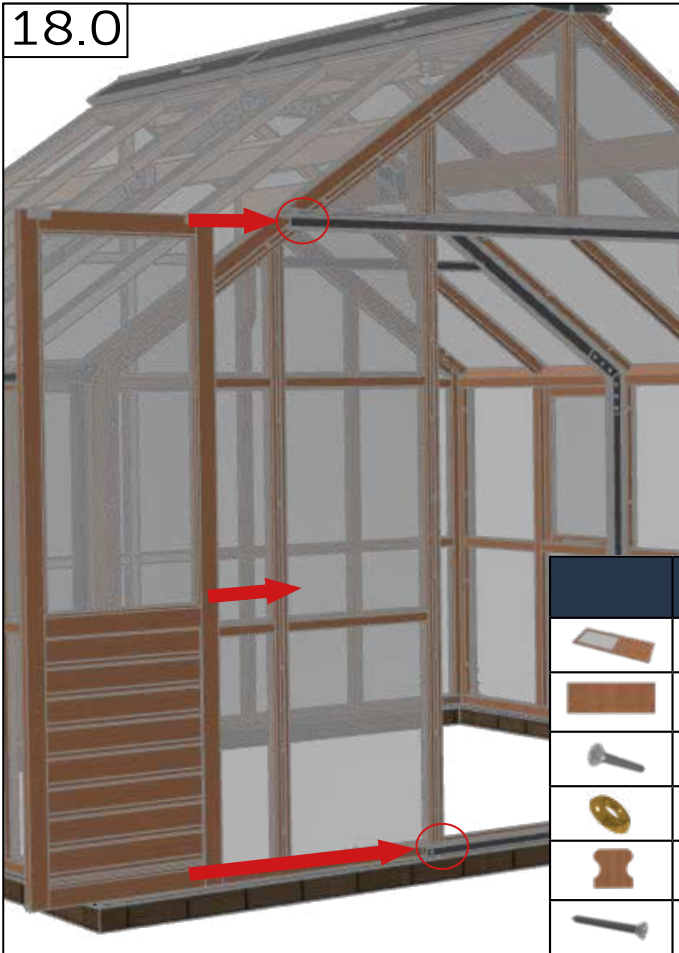

18.1

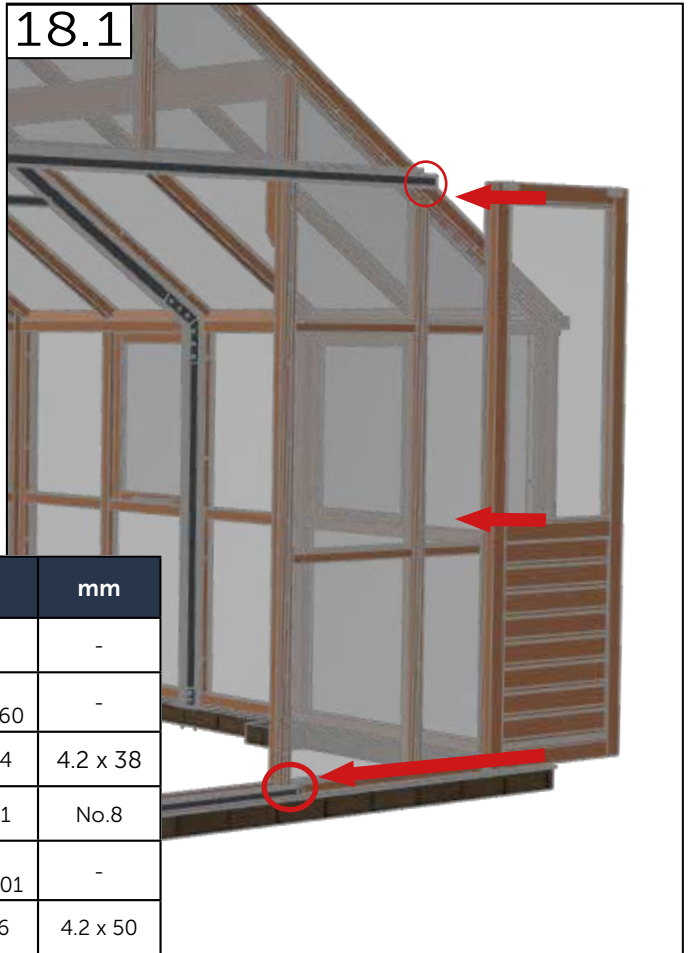

	#	mm
	A	-
	D W405-60	-
	SC024	4.2 x 38
	WA301	No.8
	E W056-01	-
	SC026	4.2 x 50

18.2

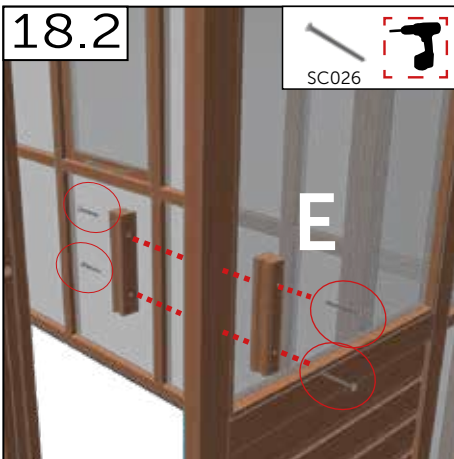

18.4

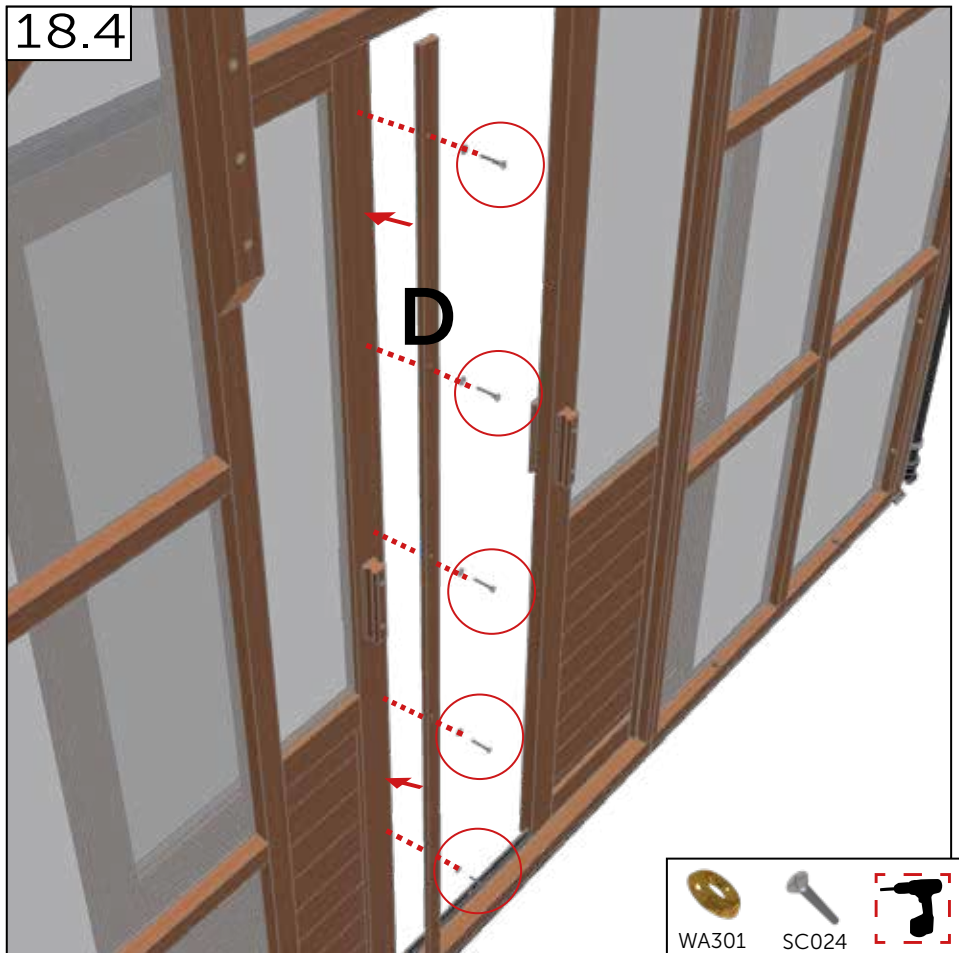

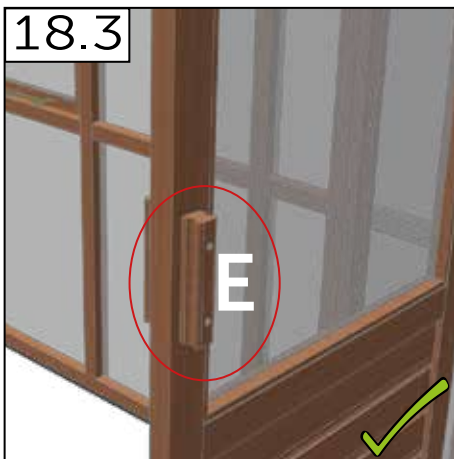

18.3



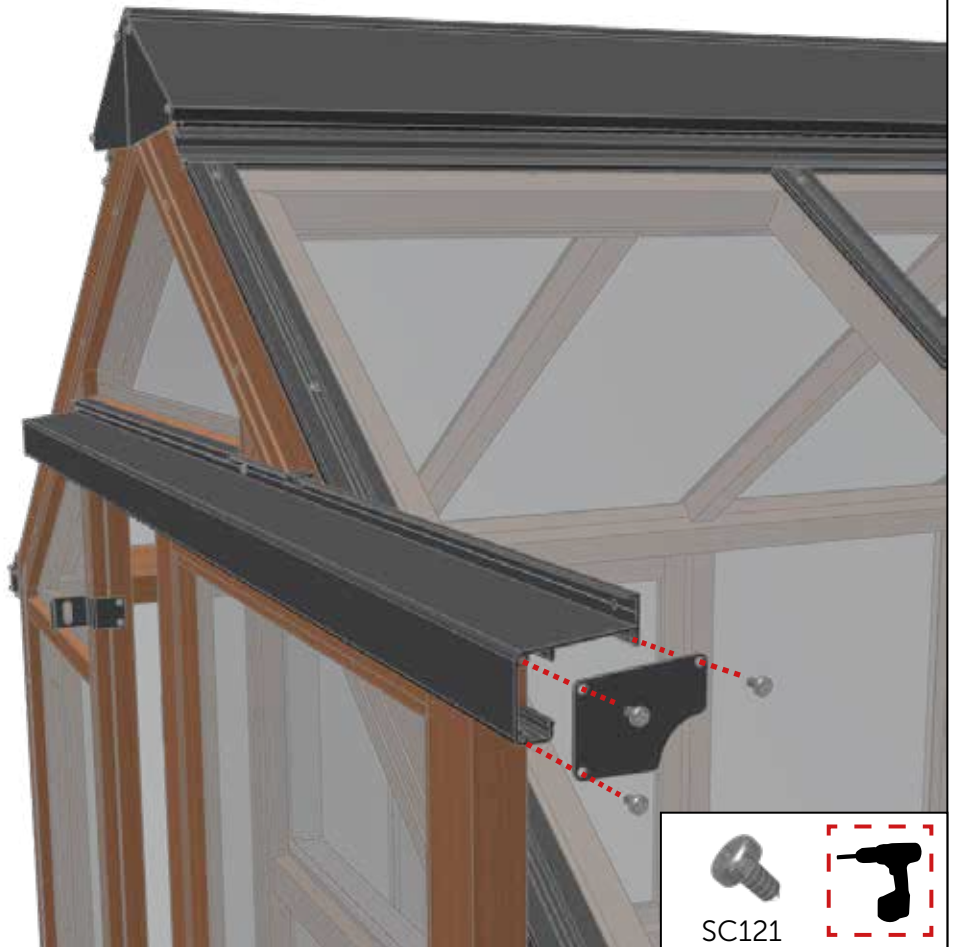

19.0



	#	mm
	SC121	4.2 x 9.5
	AL3002	-





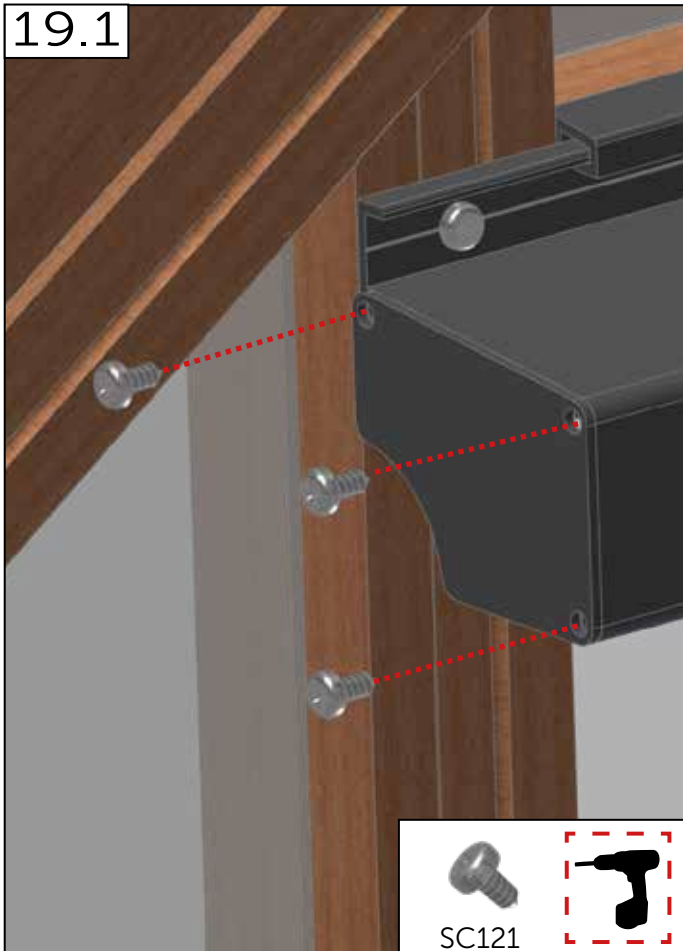

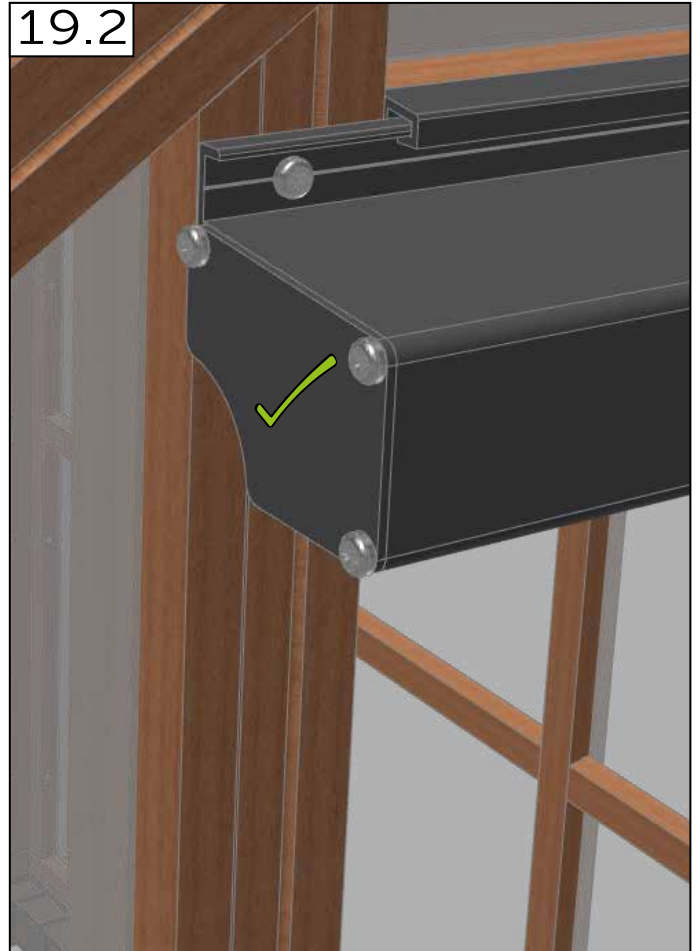

19.1

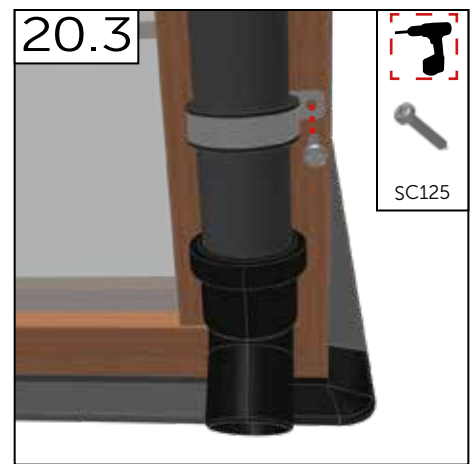
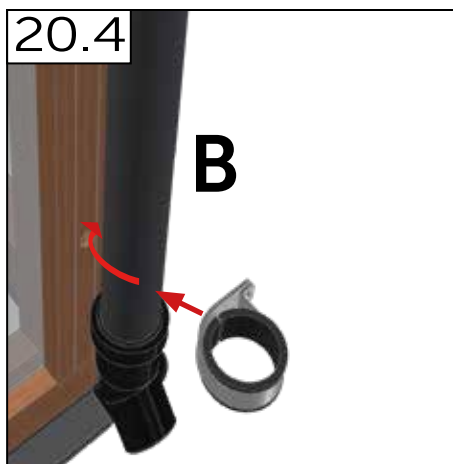
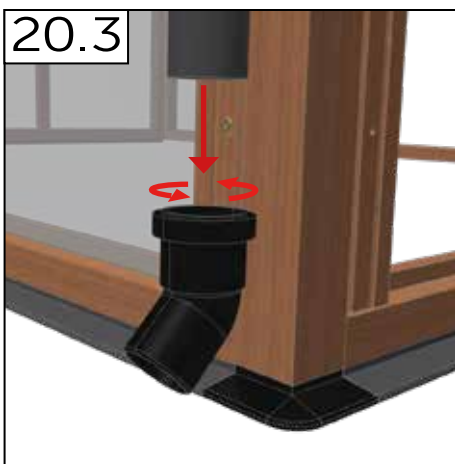
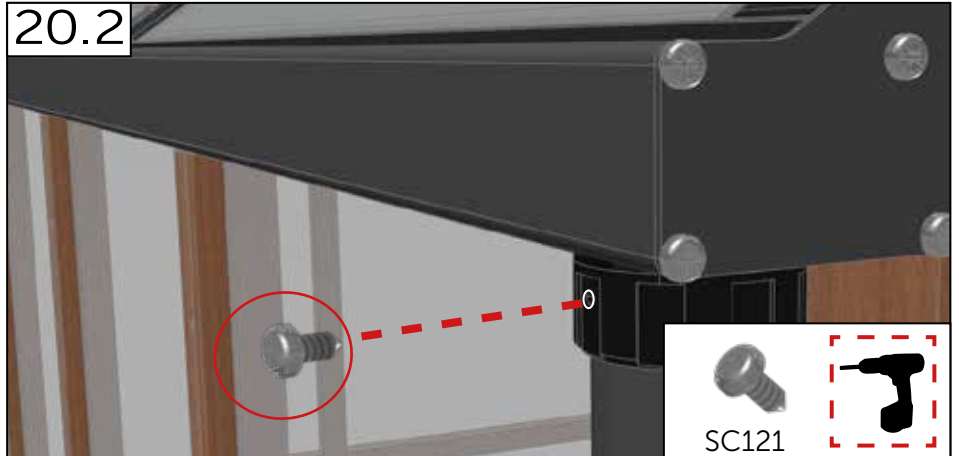
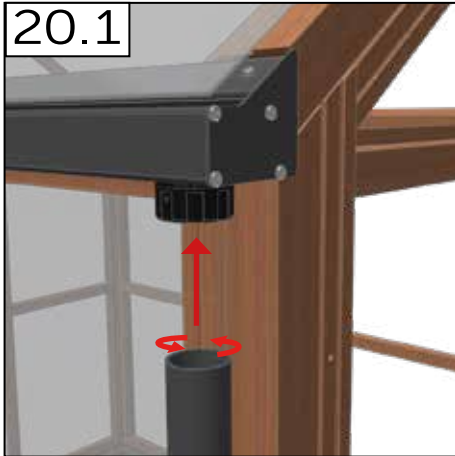

19.2





	#	mm
	SC121	4.2 x 9.5
	SC125	4.2 x 25
	B AL2016	1447
	PT201	-
	PT203	-









G A B R I E L A S H

[www.gabrielash.com](http://www.gabrielash.com)

As part of our policy of continuous development and improvement.  
We reserve the right to modify any of the information set out within this document and any related documentation at any time without notice.

This product is delivered by a company in the Juliana Group - [www.juliana.com](http://www.juliana.com)

®The Royal Horticultural Society. The Royal Horticultural Society, and its logo, are trade marks of The Royal Horticultural Society.

(Registered Charity No. 222879/SC038262) and used under licence from RHS Enterprises Limited.