















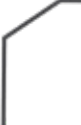

Classic Grow & Store



Classic Grand Grow & Store







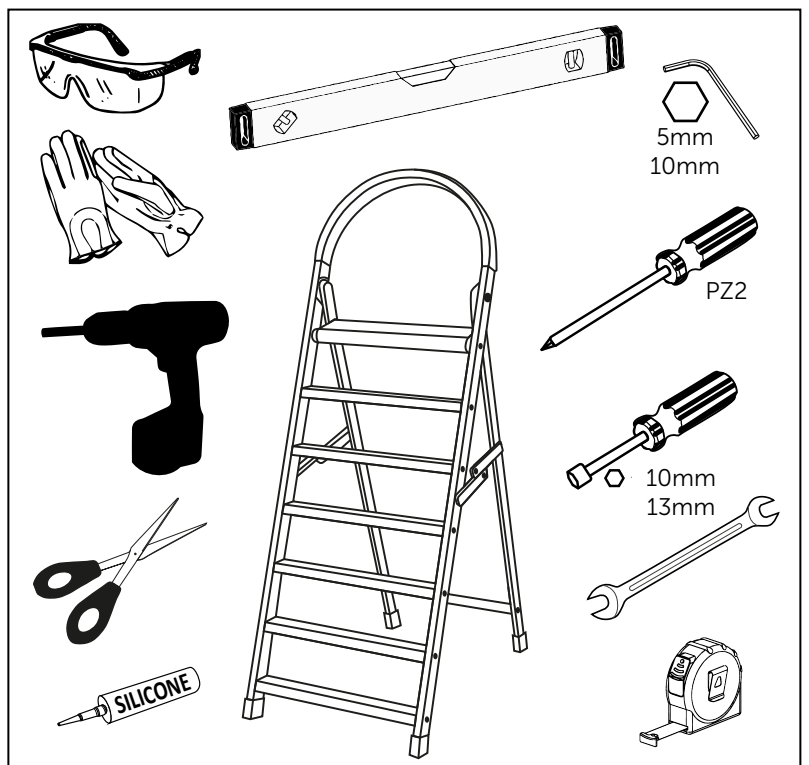
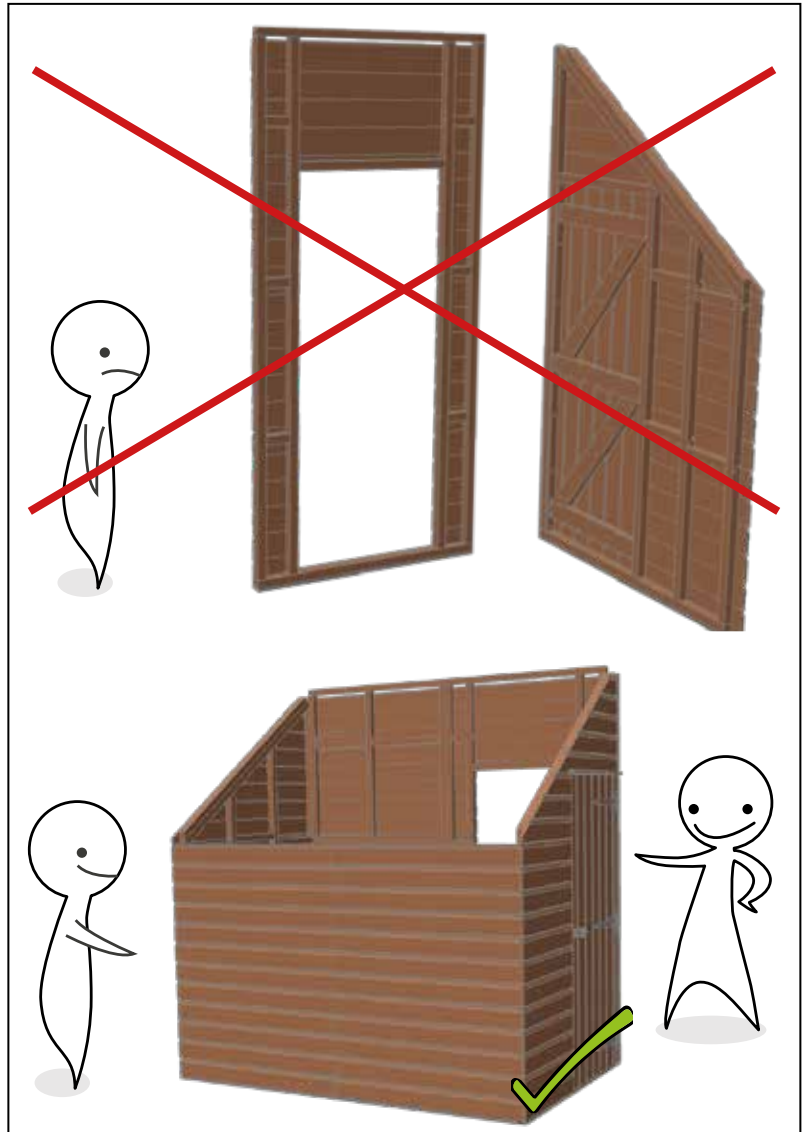

















Overview - Aperçu - Översikt - Überblick - Oversikt - Visión general - Oversigt

	
	4 - 5
	6 - 7
	8 - 13
	14 - 19
	20 - 21
	22 - 29
	30 - 35
	36 - 45
	46-55
	56
	57 - 58
	59



Portal Frame-Portique-Portal ram-Portalrahmen-Portalramme -Marco del p6rtico - Portal ramme

	#	mm
Classic Grow & Store		
	A AL2018	1552
	B AL2018	1212
	C AL2018	453
	D AL2018	1559
	E AL2018	1199
	F AL2018	200
	AL3067	-
	AL3059	-
	AL3060	-
Classic Grand Grow & Store		
	A AL2018	1556
	B AL2018	1823
	C AL2018	3888
	D AL2018	1783
	E AL2018	1678
	F AL2018	302
	AL3067	-
	AL3064	-
	AL3065	-
	AL3061	-
	AL3062	-
Screws & washes		
	BL153	M8 x 20
	WA205	M8
	NU102	M8

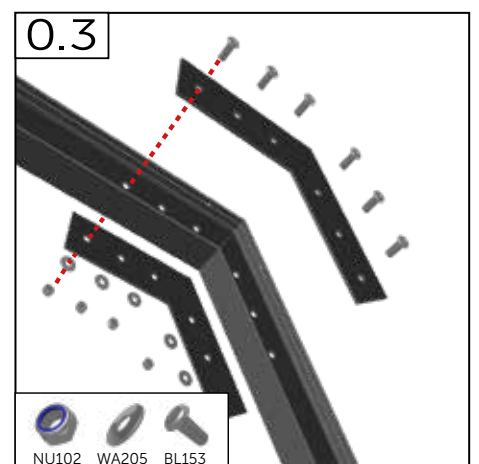
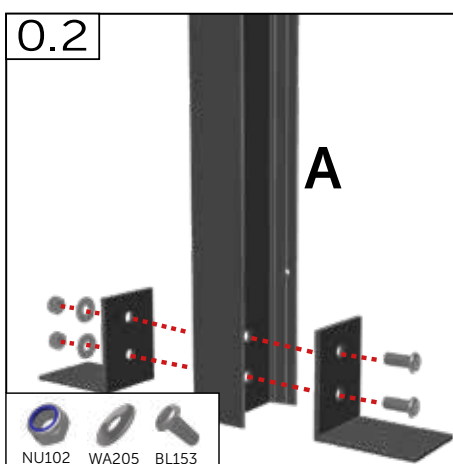
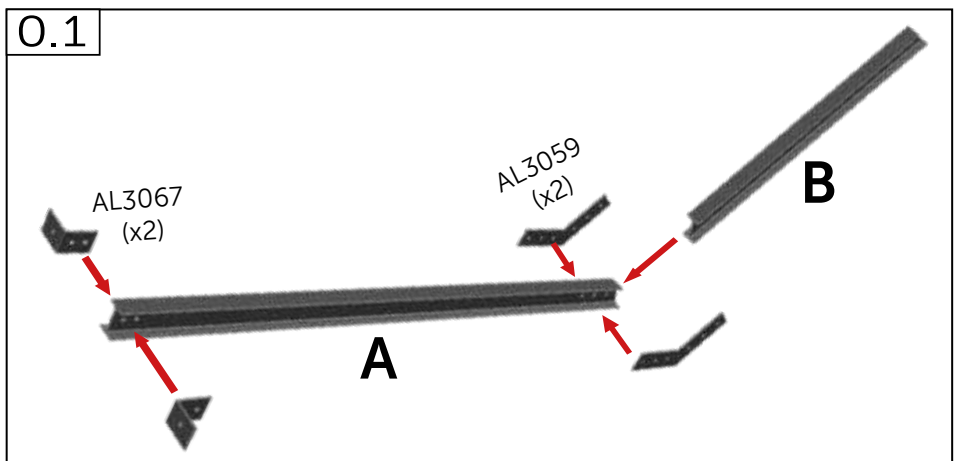
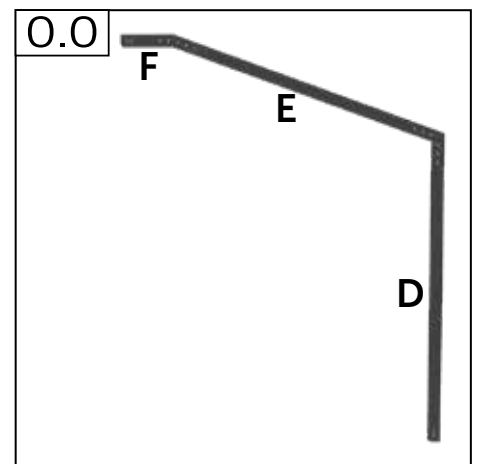
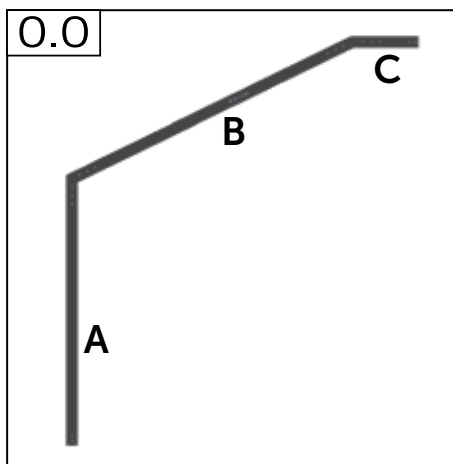
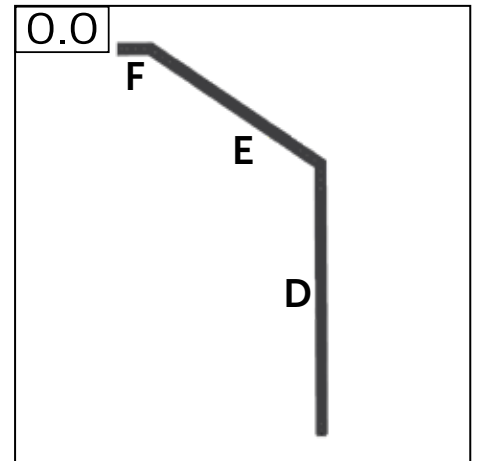
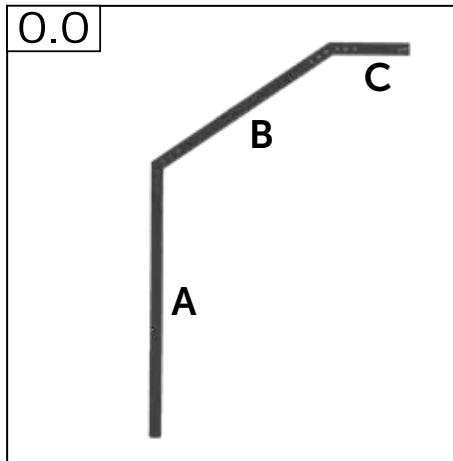

Portal Frame-Portique-Portal ram-Portalrahmen-Portalramme
-Marco del pórtico - Portal ramme

0.4

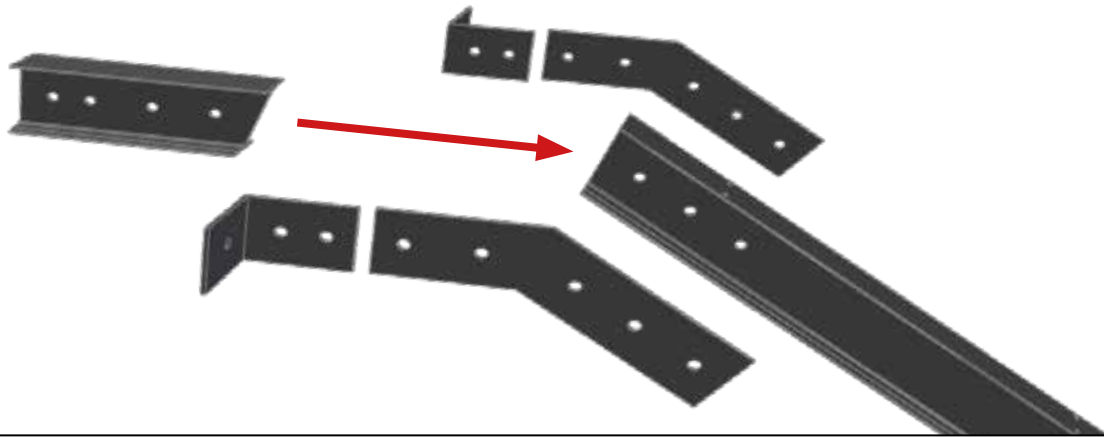

0.4

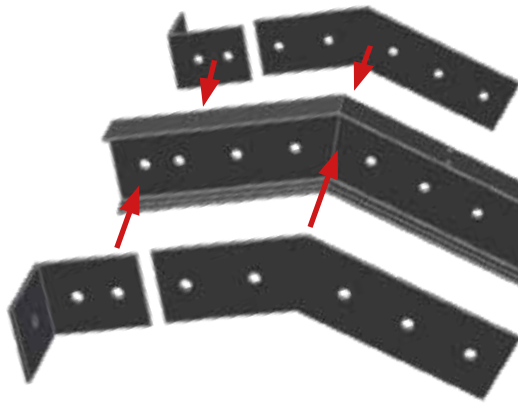

0.4

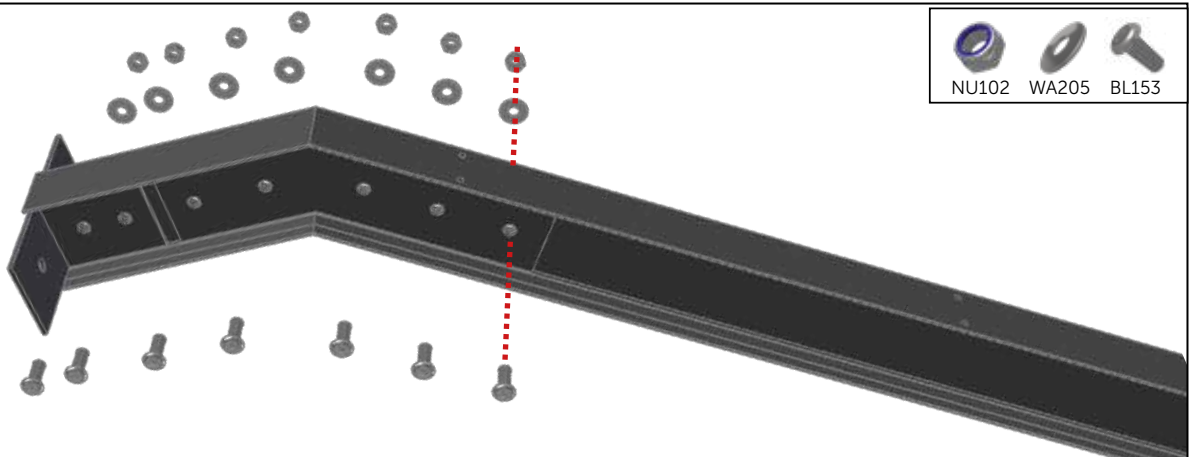

0.4

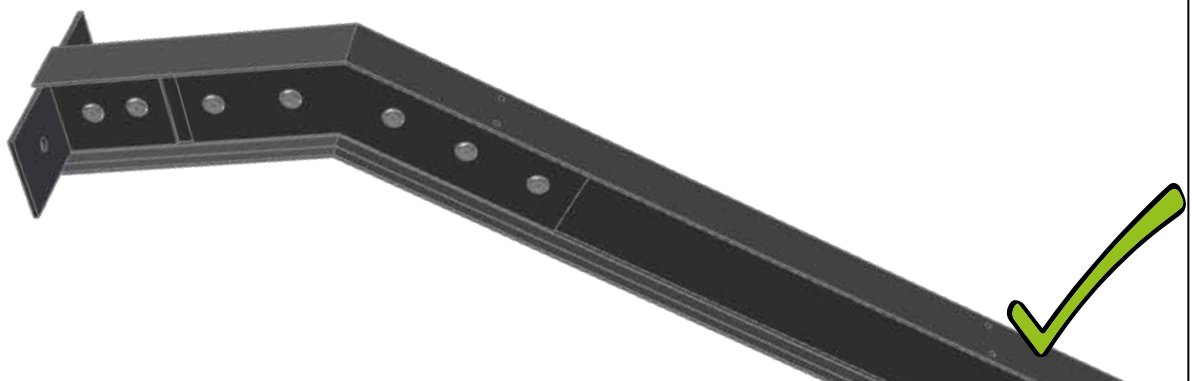

1.0

SA8700

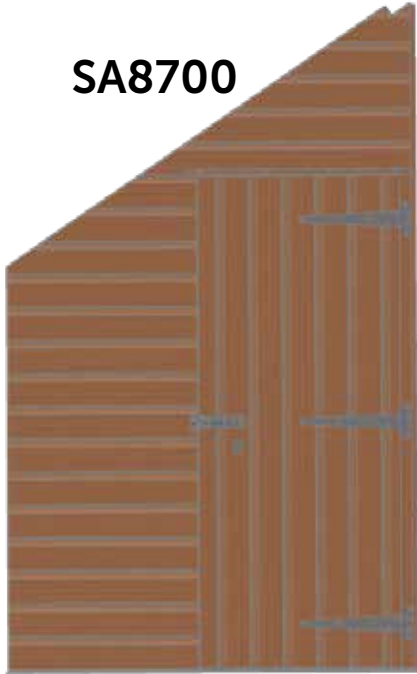

SA8701



SA8703



SA8702

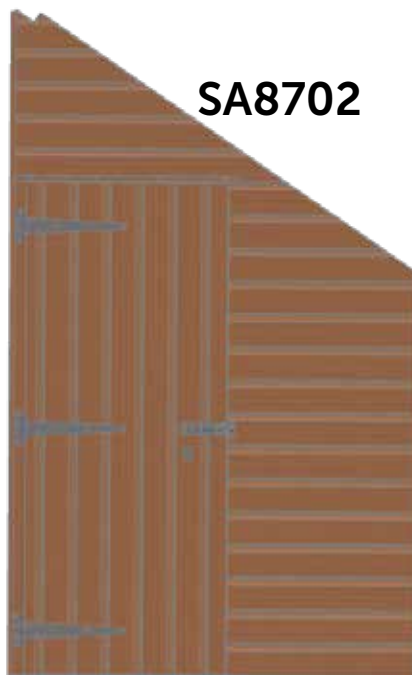

	#	mm
	SA8700	Grow & Store
	SA8701	Grow & Store
	SA8702	Grow & Store
	SA8703	Grow & Store
	SA8704	Grand Grow & Store
	SA8705	Grand Grow & Store
	SA8707	Grand Grow & Store
	SA8708	Grand Grow & Store

1.0

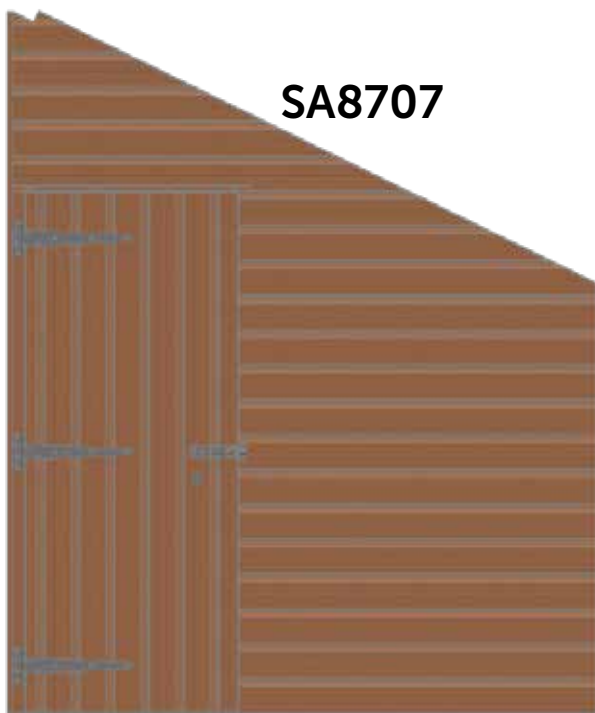
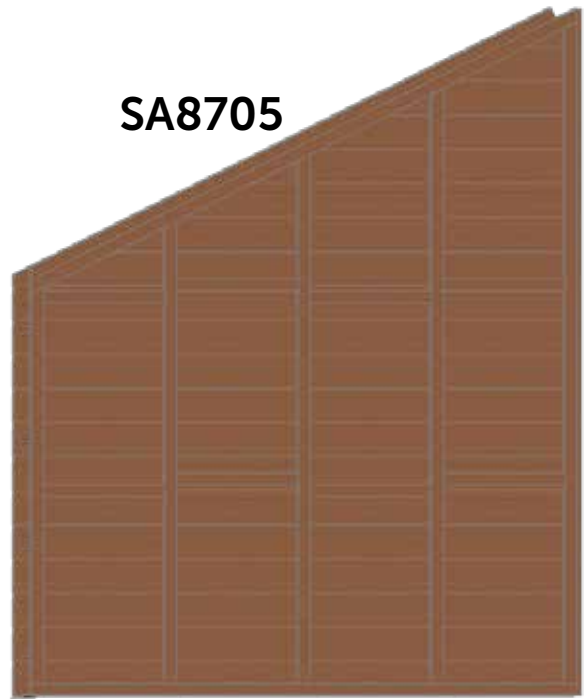
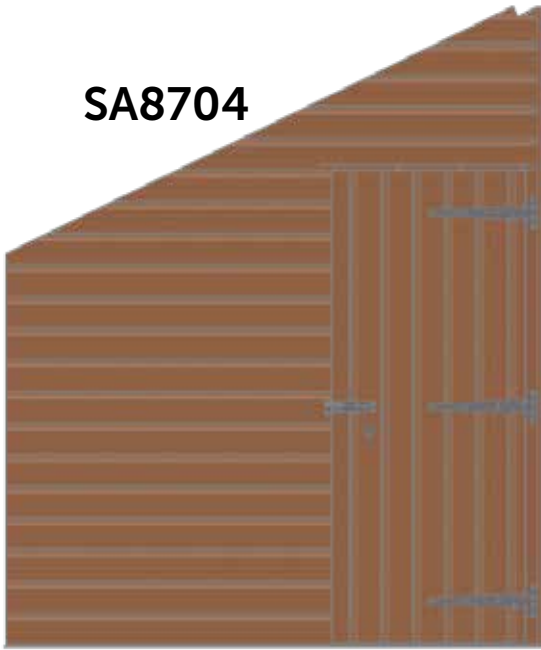

Side Panels - Des panneaux latéraux - Sidpaneler - Seitenleiste
 - Sidepaneler - Paneles laterales - Sidepaneler

2.0



SA8709 LH



SA8710 LH
SA8711 RH

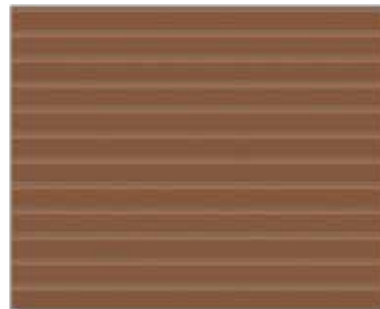

SA8712 LH
SA8713 RH



SA8725 MID

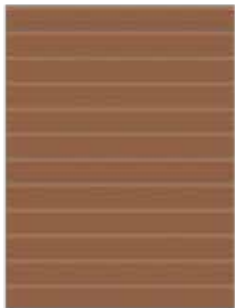



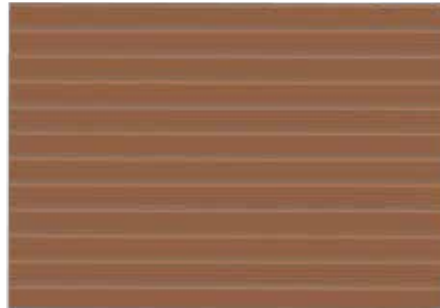



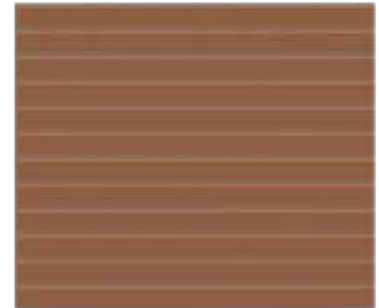

SA8726 MID



SA8727 MID



SA8729

	#	mm
	SA8709	1216
	SA8710 SA8711	1192 1216
	SA8712 SA8713	1790 1790
	SA8725	574
	SA8726	1148
	SA8727	1746
	SA8729	1834
	SC057	4.8 x 80

3 PANEL

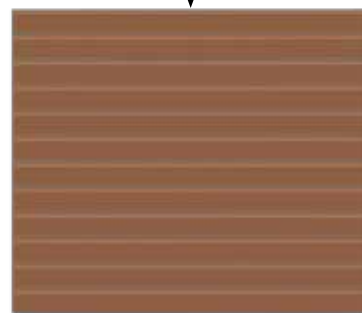

SA8729

4 PANEL

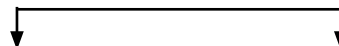

SA8710 LH



SA8711 RH

Side Panels - Des panneaux latéraux - Sidpaneler - Seitenleiste - Sidepaneler
- Paneles laterales - Sidepaneler

2.1

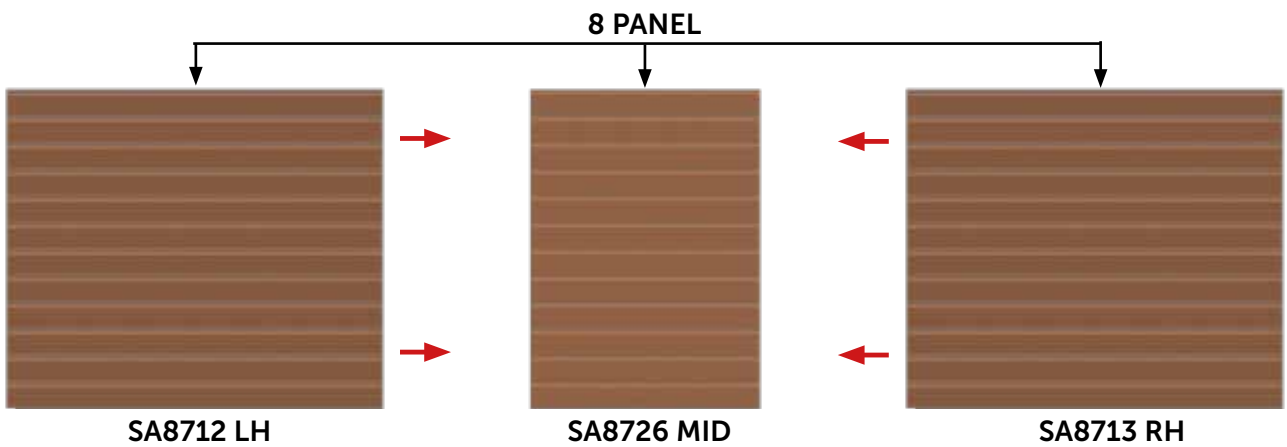
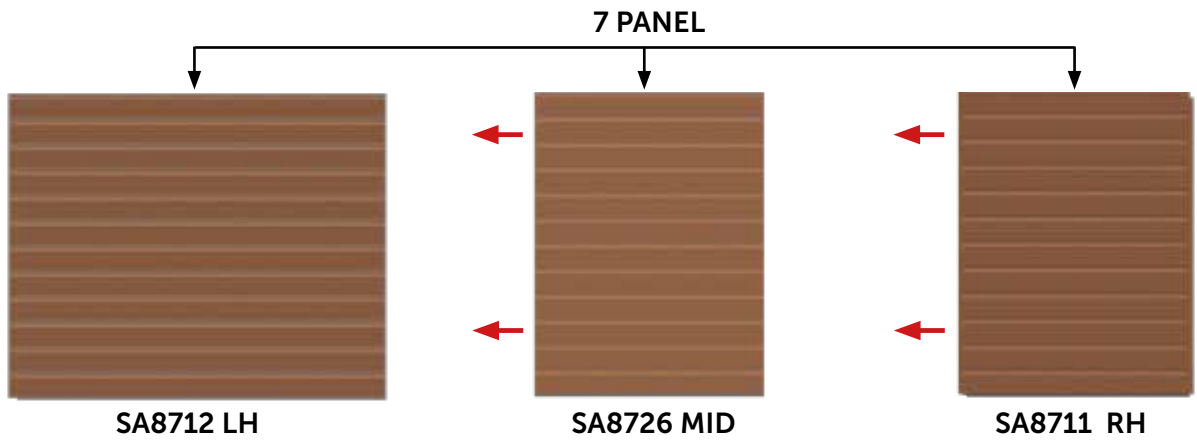

Side Panels - Des panneaux latéraux - Sidpaneler - Seitenleiste
 - Sidepaneler - Paneles laterales - Sidepaneler

2.1

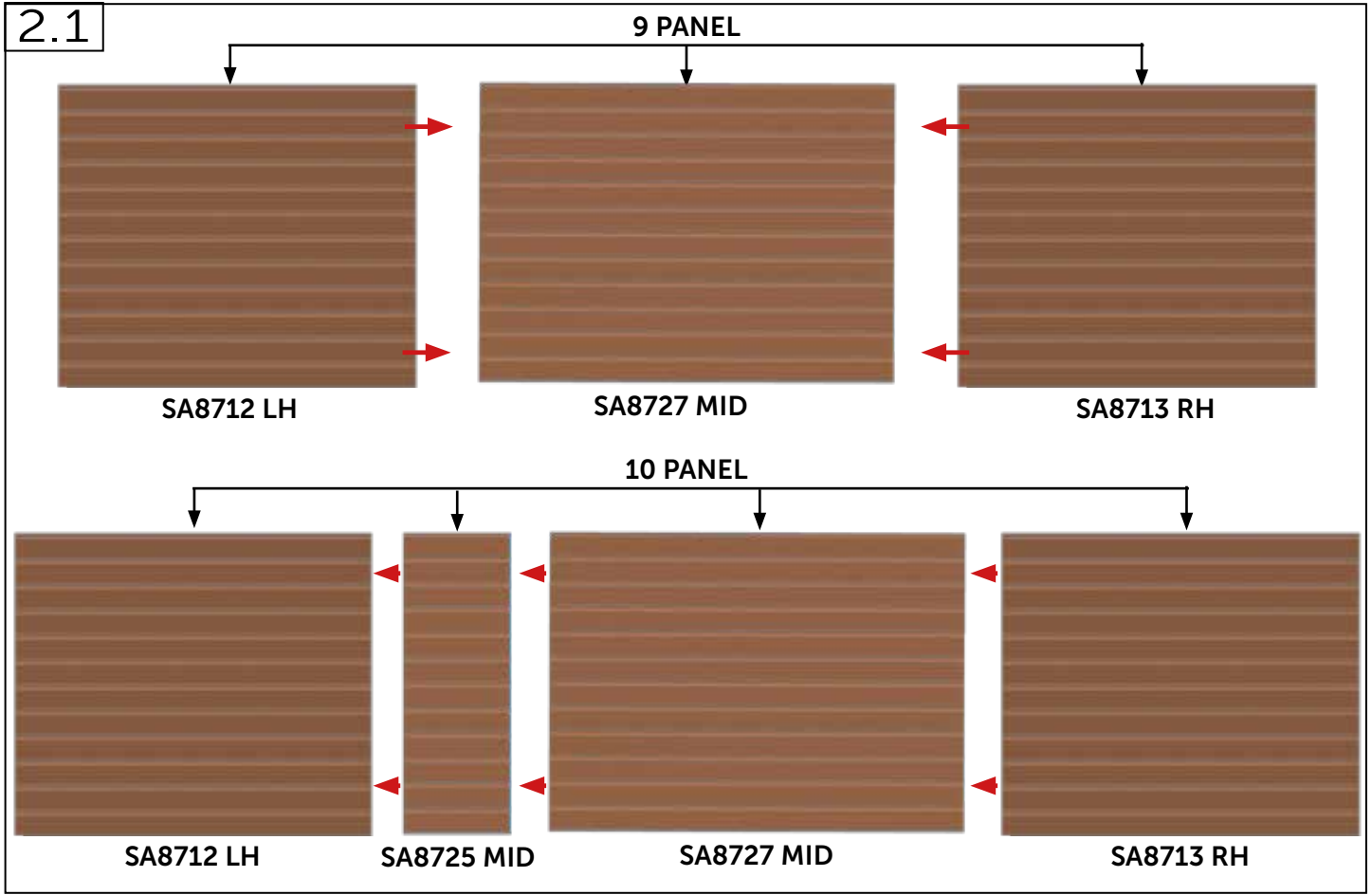

2.1

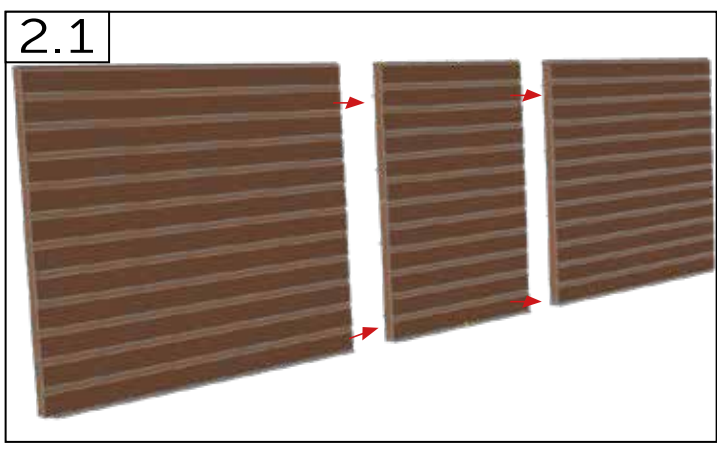

2.2

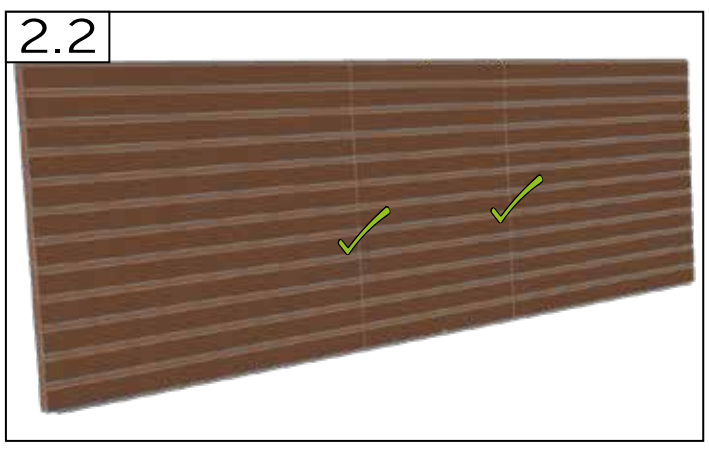

2.2

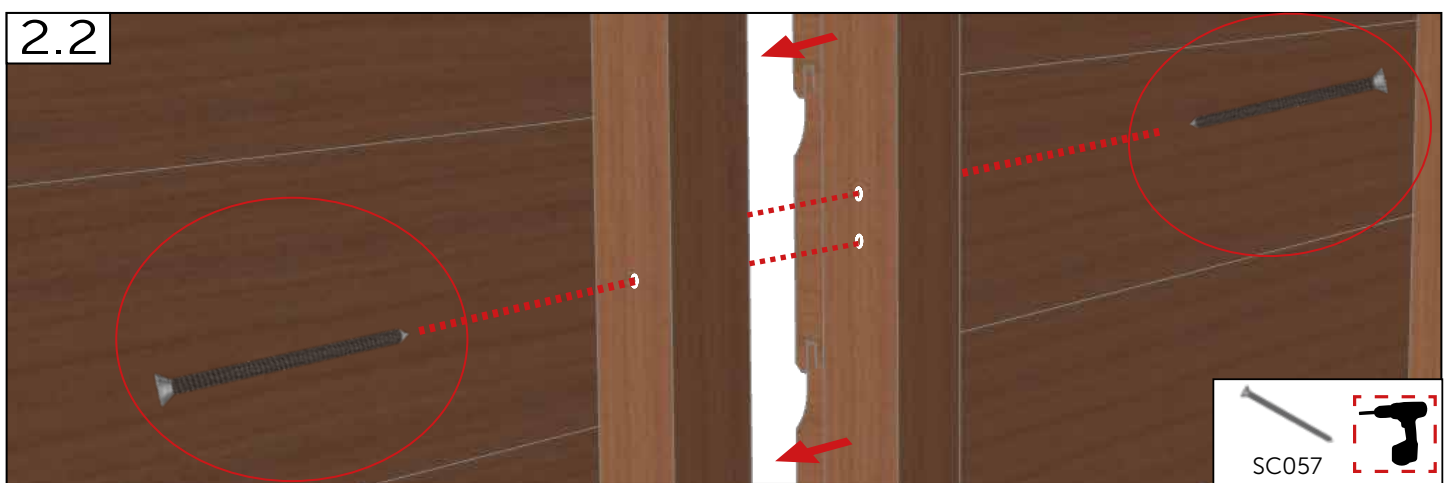

Side Panels - Des panneaux latéraux - Sidpaneler - Seitenleiste - Sidepaneler
 - Paneles laterales - Sidepaneler

3.0

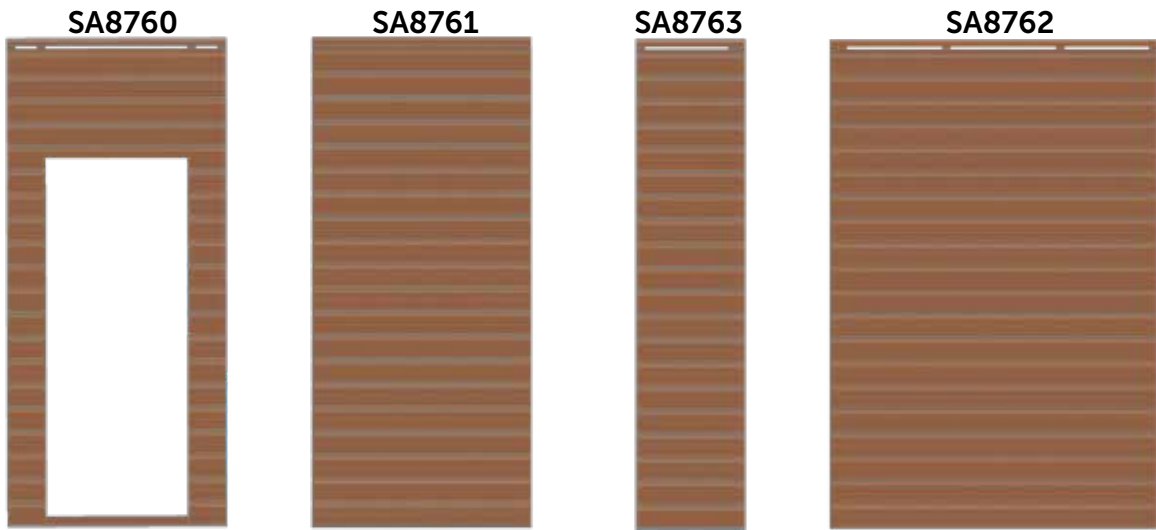

3 PANEL (RH AS OPPOSITE)

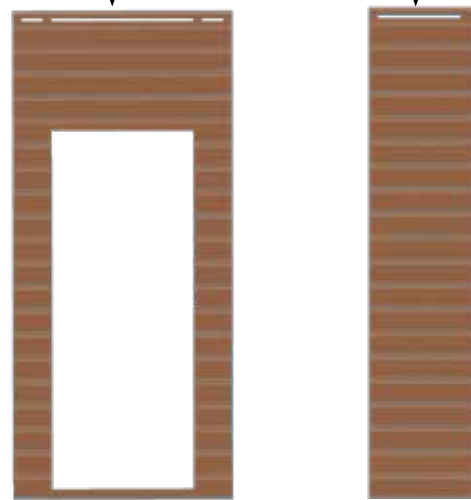

SA8760



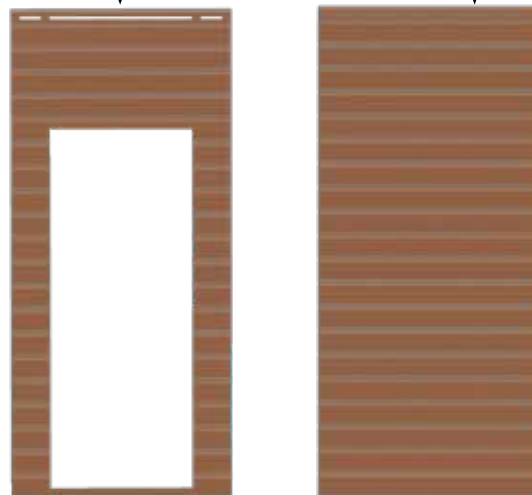

SA8763

4 PANEL (RH AS OPPOSITE)



SA8760

SA8761

	#	mm
	SA8760	1172
	SA8761	1148
	SA8762	1746
	SA8763	574
	SC057	4.2 x 80

Side Panels - Des panneaux latéraux - Sidpaneler - Seitenleiste
- Sidepaneler - Paneles laterales - Sidepaneler

3.1

5 PANEL (RH AS OPPOSITE)

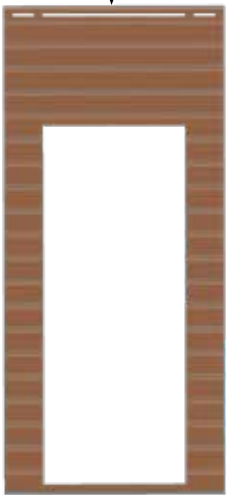

SA8760

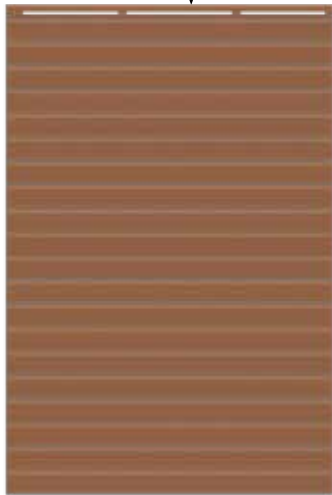

SA8762

6 PANEL (RH AS OPPOSITE)

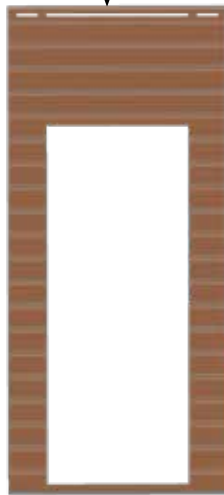

SA8760



SA8763

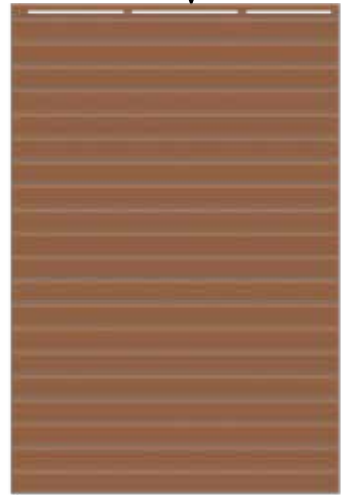

SA8762

7 PANEL (RH SHED AS OPPOSITE)

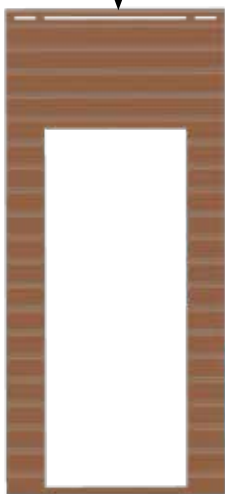

SA8760



SA8763



SA8763

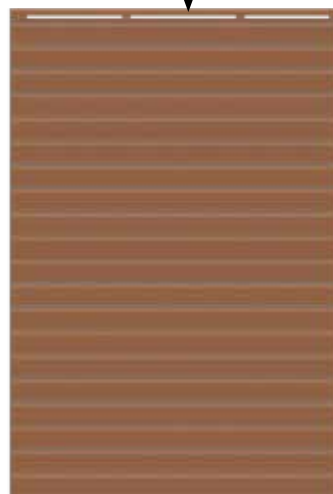

SA8762

8 PANEL (RH SHED AS OPPOSITE)

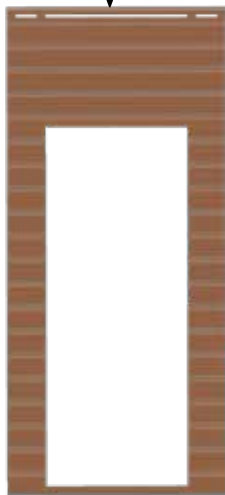

SA8760



SA8761

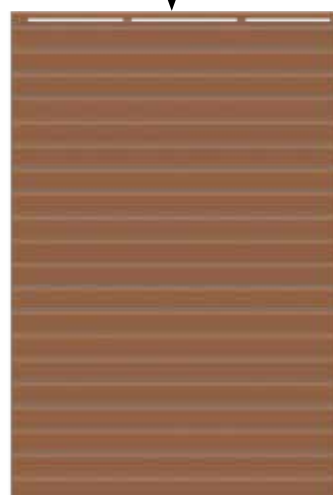

SA8762



SA8763

Side Panels - Des panneaux latéraux - Sidpaneler - Seitenleiste - Sidepaneler
- Paneles laterales - Sidepaneler

3.1

9 PANEL (RH SHED AS OPPOSITE)

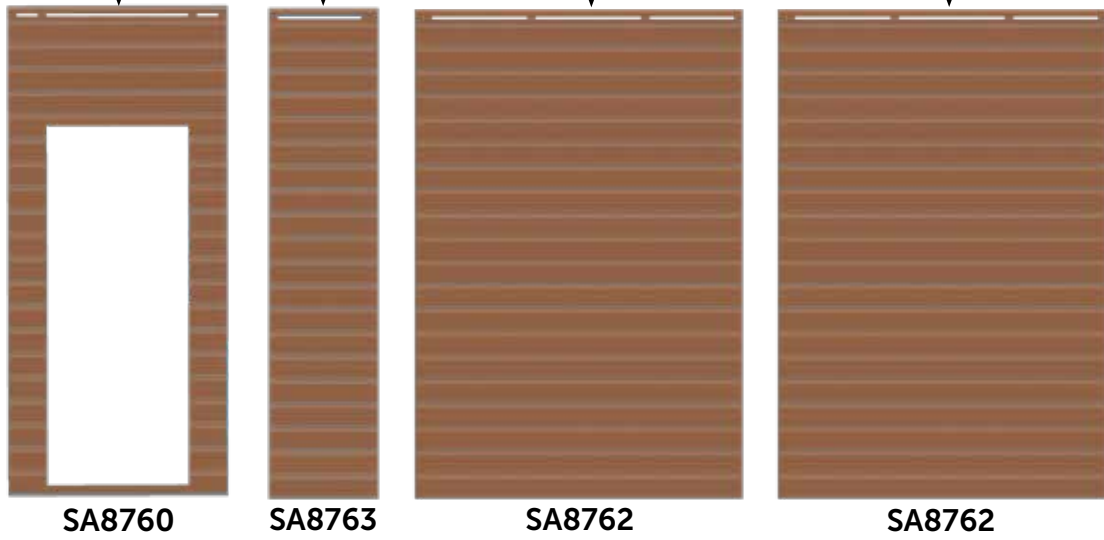

10 PANEL (RH SHED AS OPPOSITE)

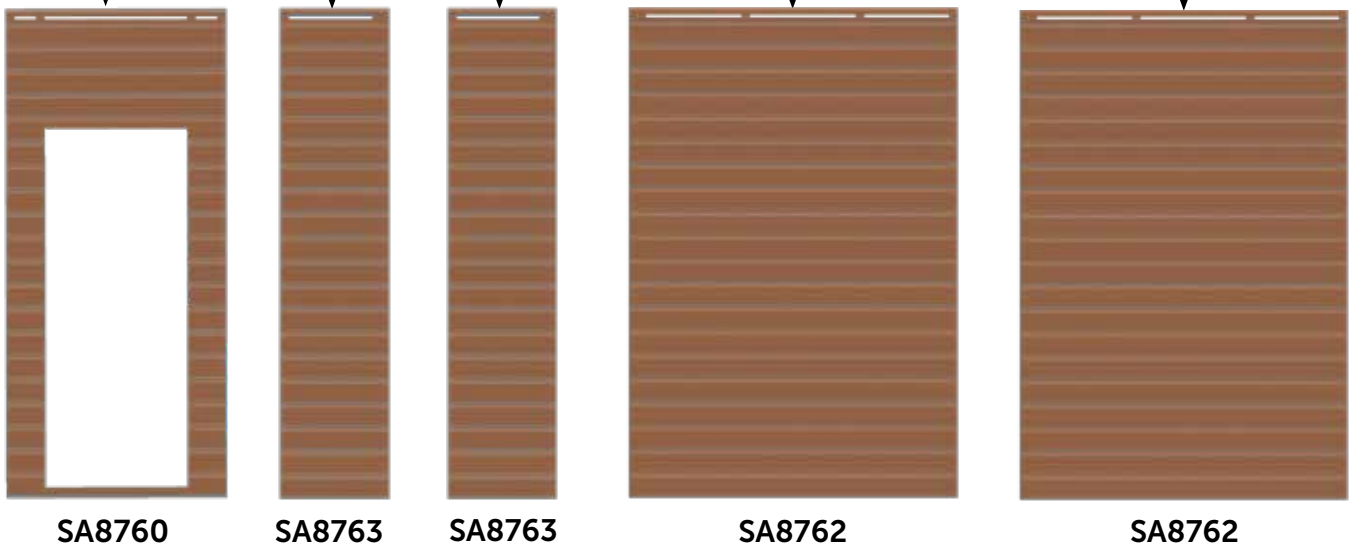

3.2

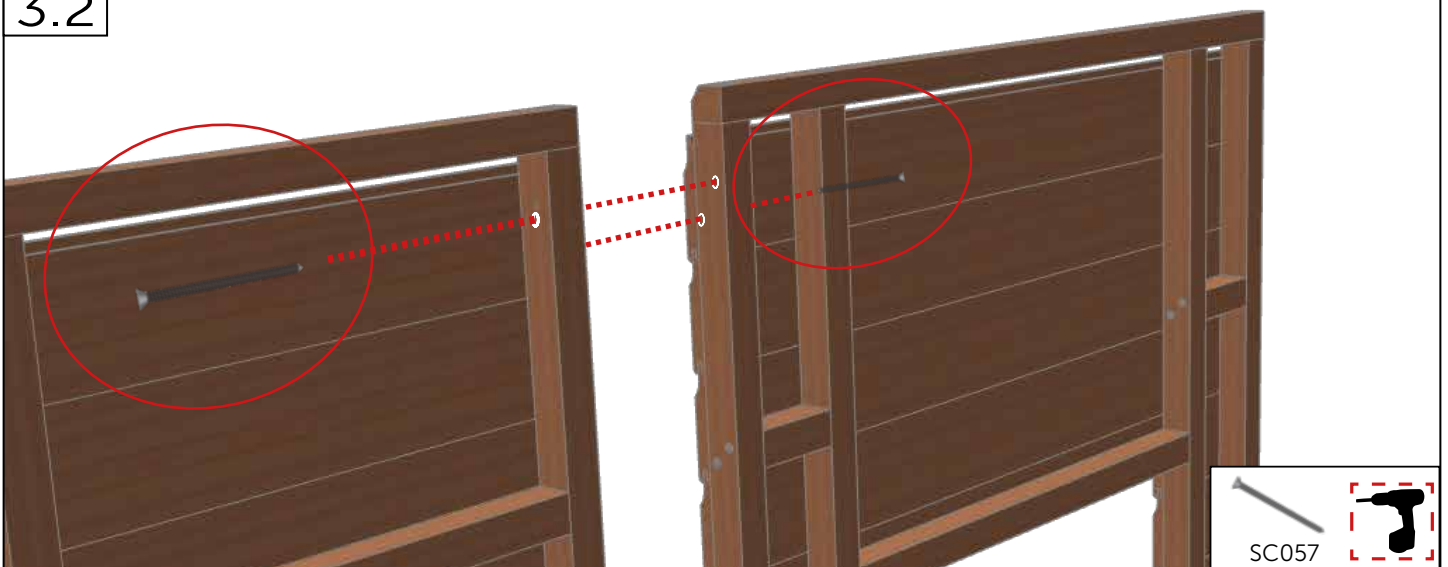

Assemble - Assembler - Montera - Montieren - Montere - Armar - Samle
 (Classic Grow & Store by 4 Panel Example)

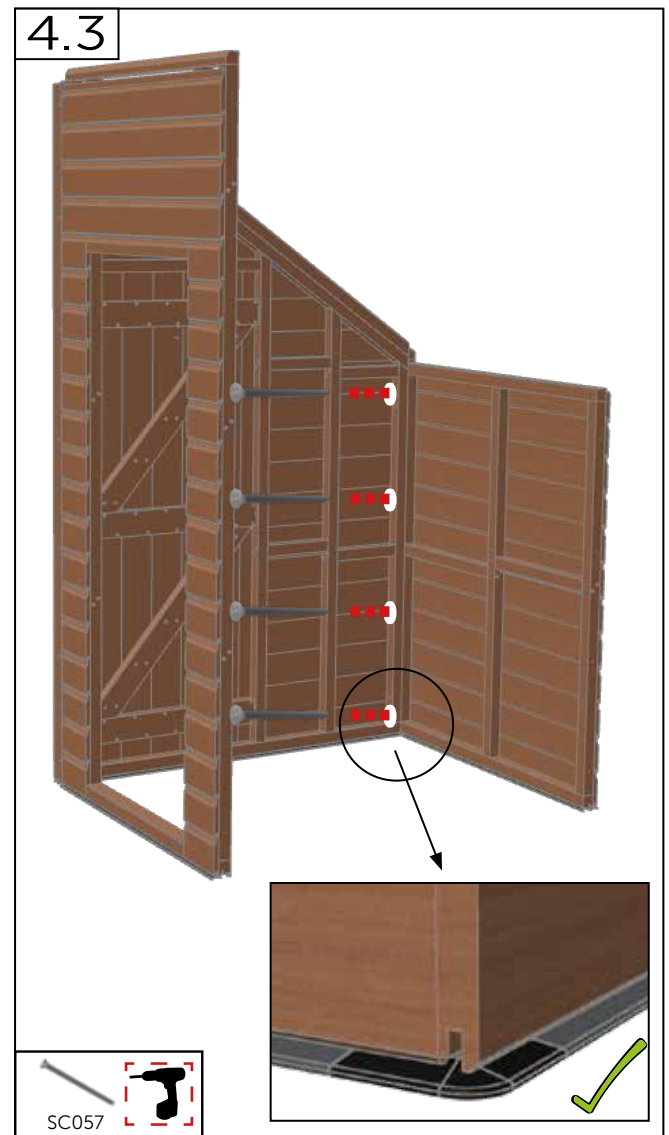
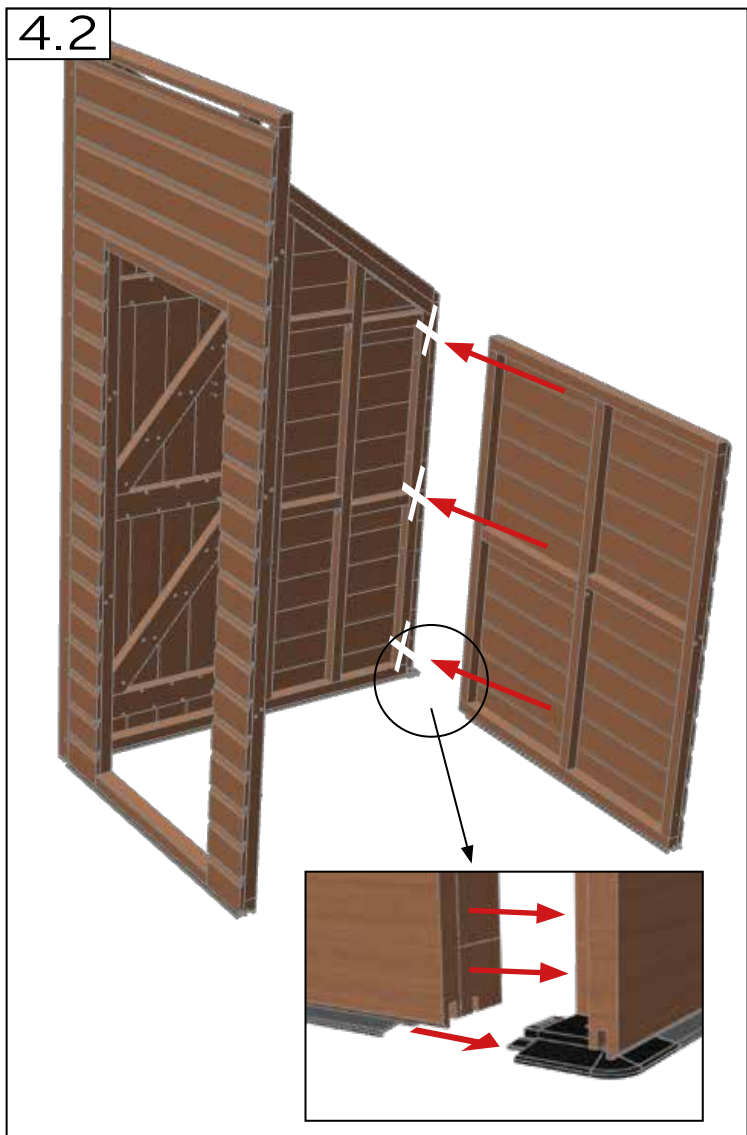
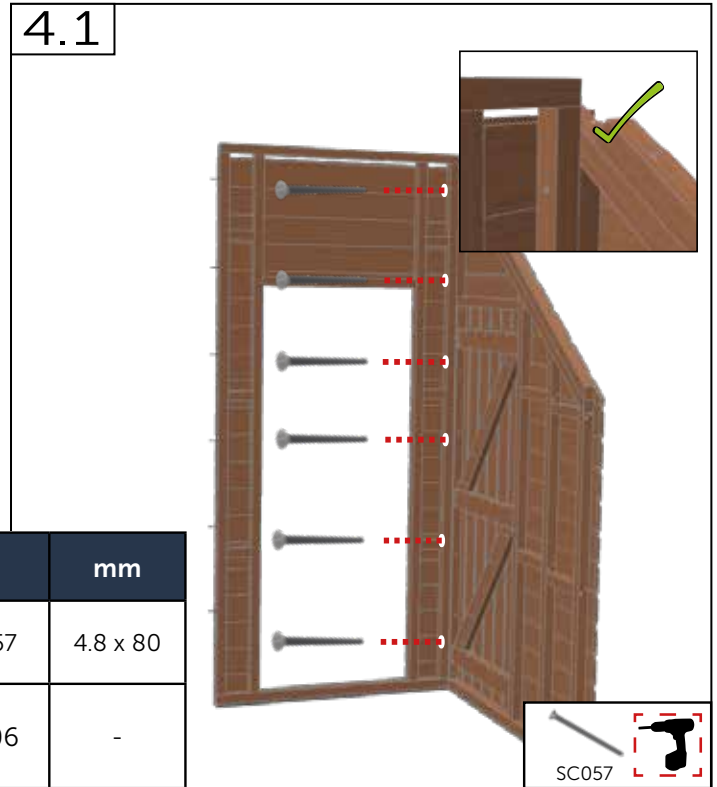
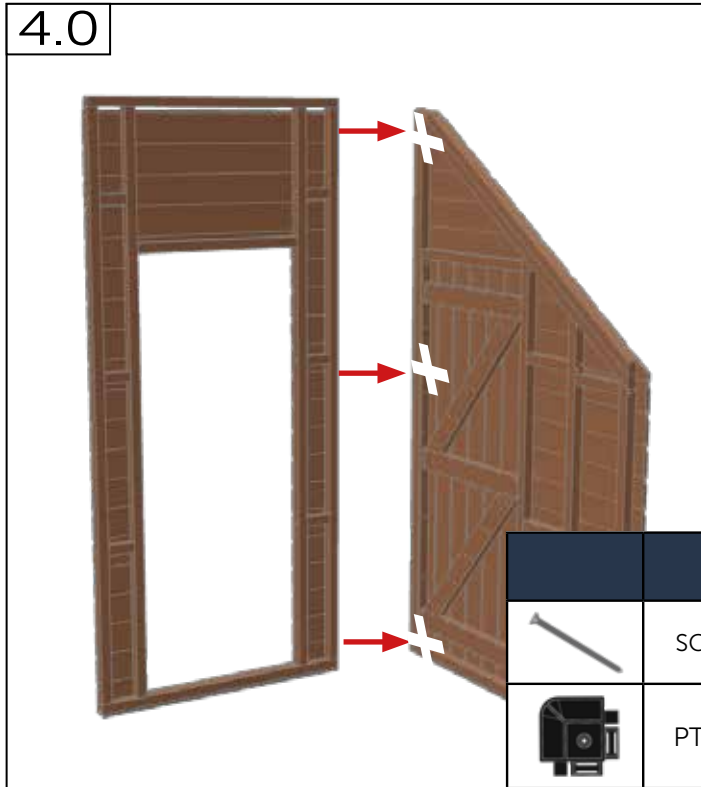

Assemble - Assembler - Montera - Montieren - Montere - Armar - Samle (Classic Grow & Store by 4 Panel Example)

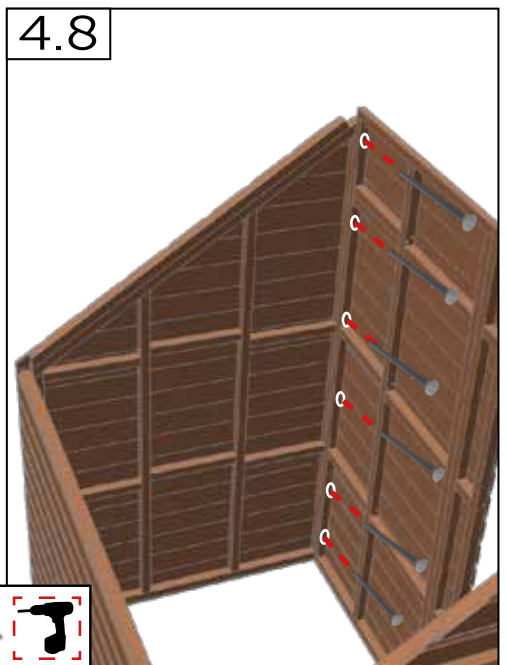
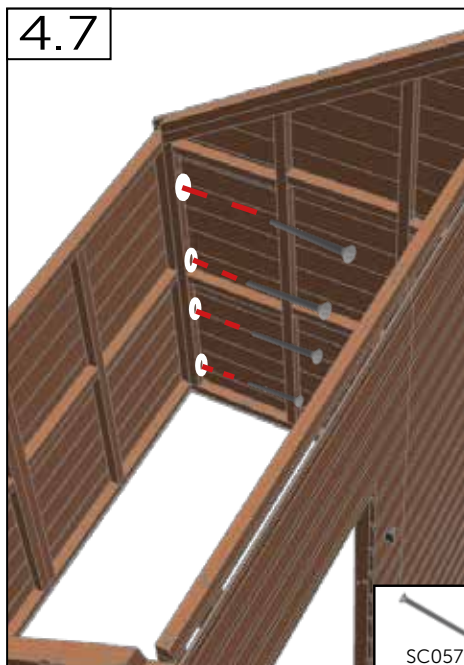
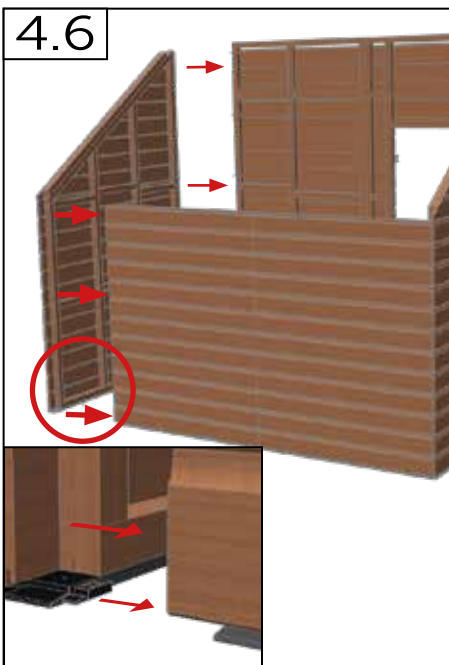
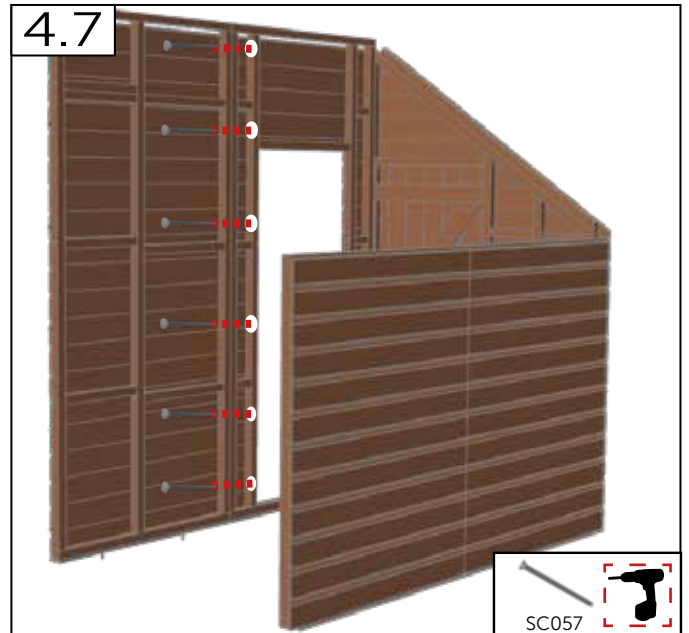
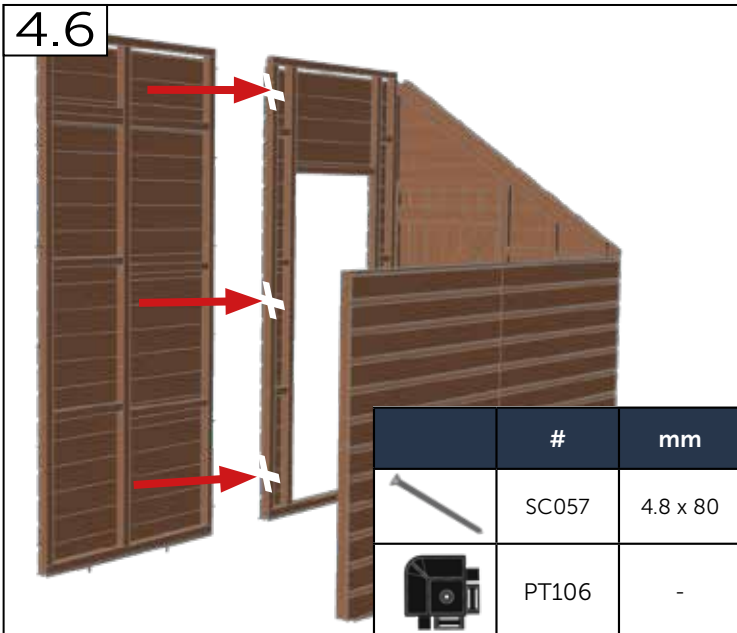
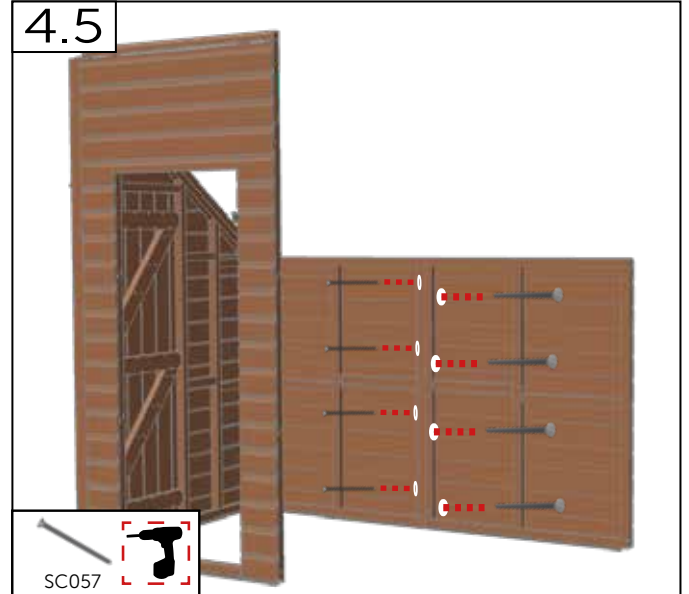
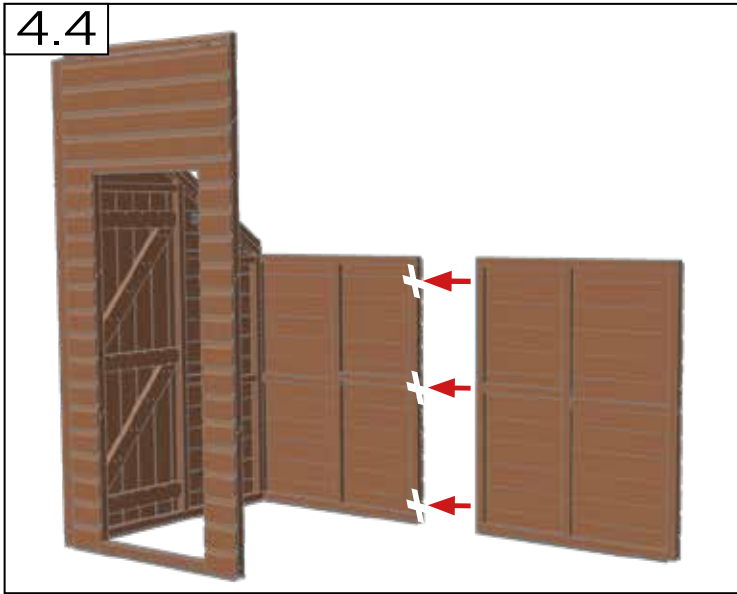

Assemble - Assembler - Montera - Montieren - Montere - Armar - Samle
(Classic Grand Grow & Store by 10 Panel Example)

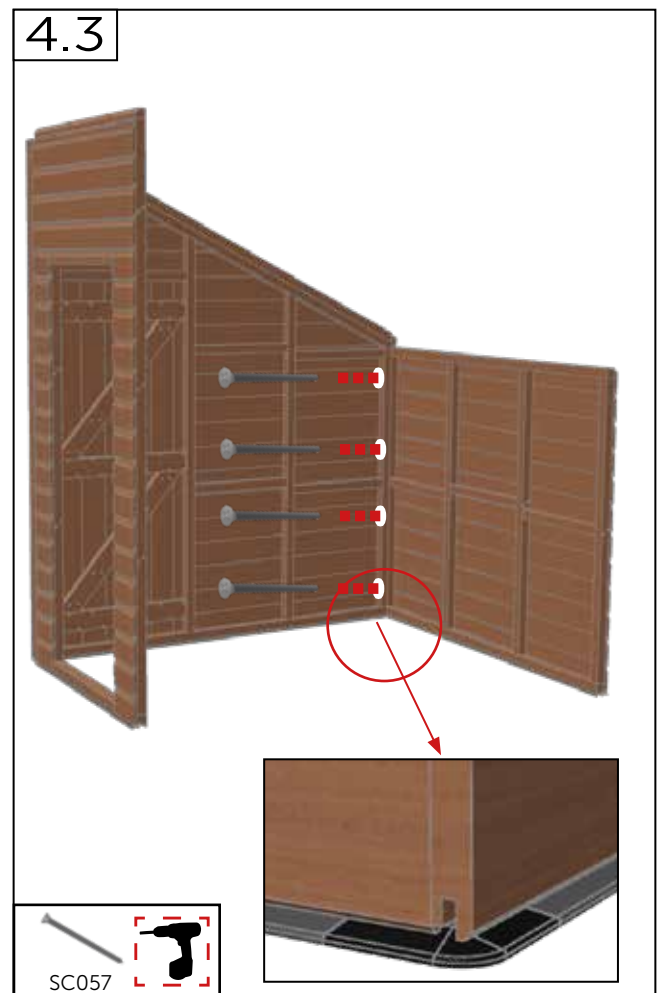
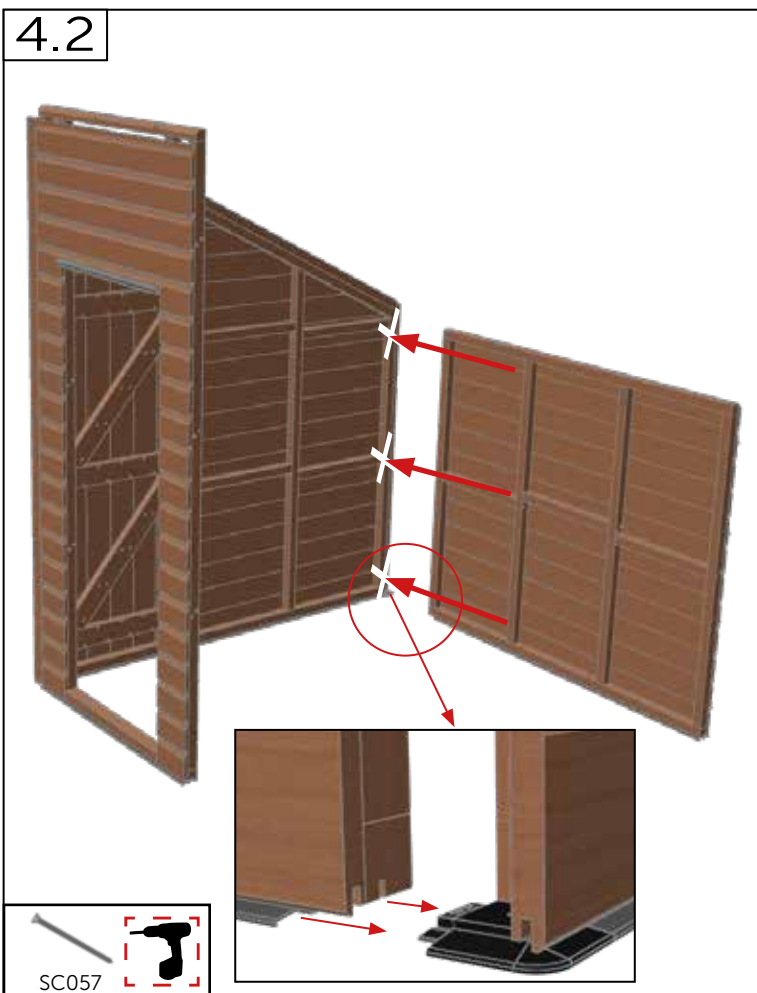
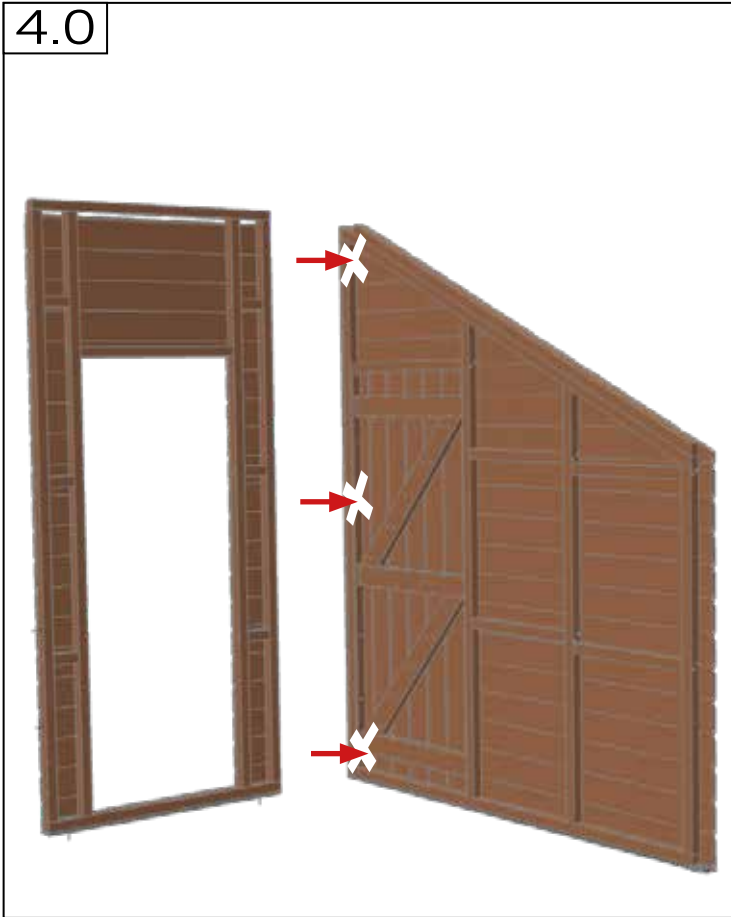

Assemble - Assembler - Montera - Montieren - Montere - Armar - Samle
(Classic Grand Grow & Store by 10 Panel Example)

4.4

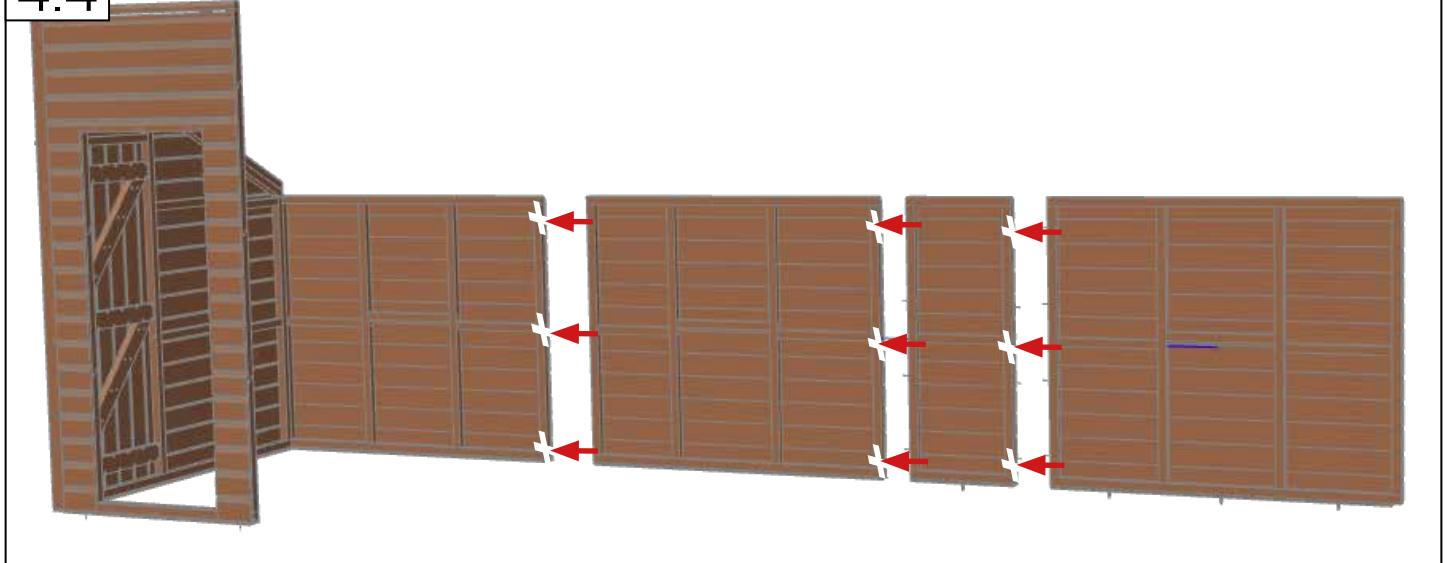

4.5



4.6

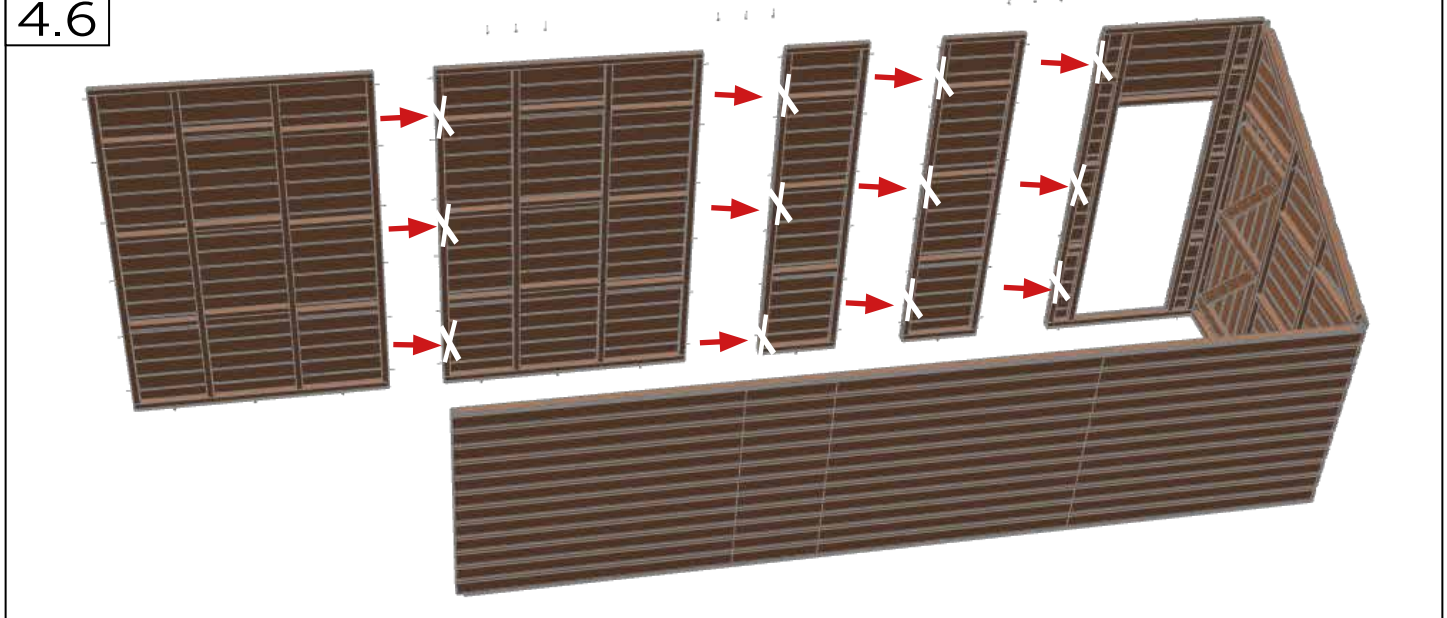

Assemble - Assembler - Montera - Montieren - Montere - Armar - Samle
(Classic Grand Grow & Store by 10 Panel Example)

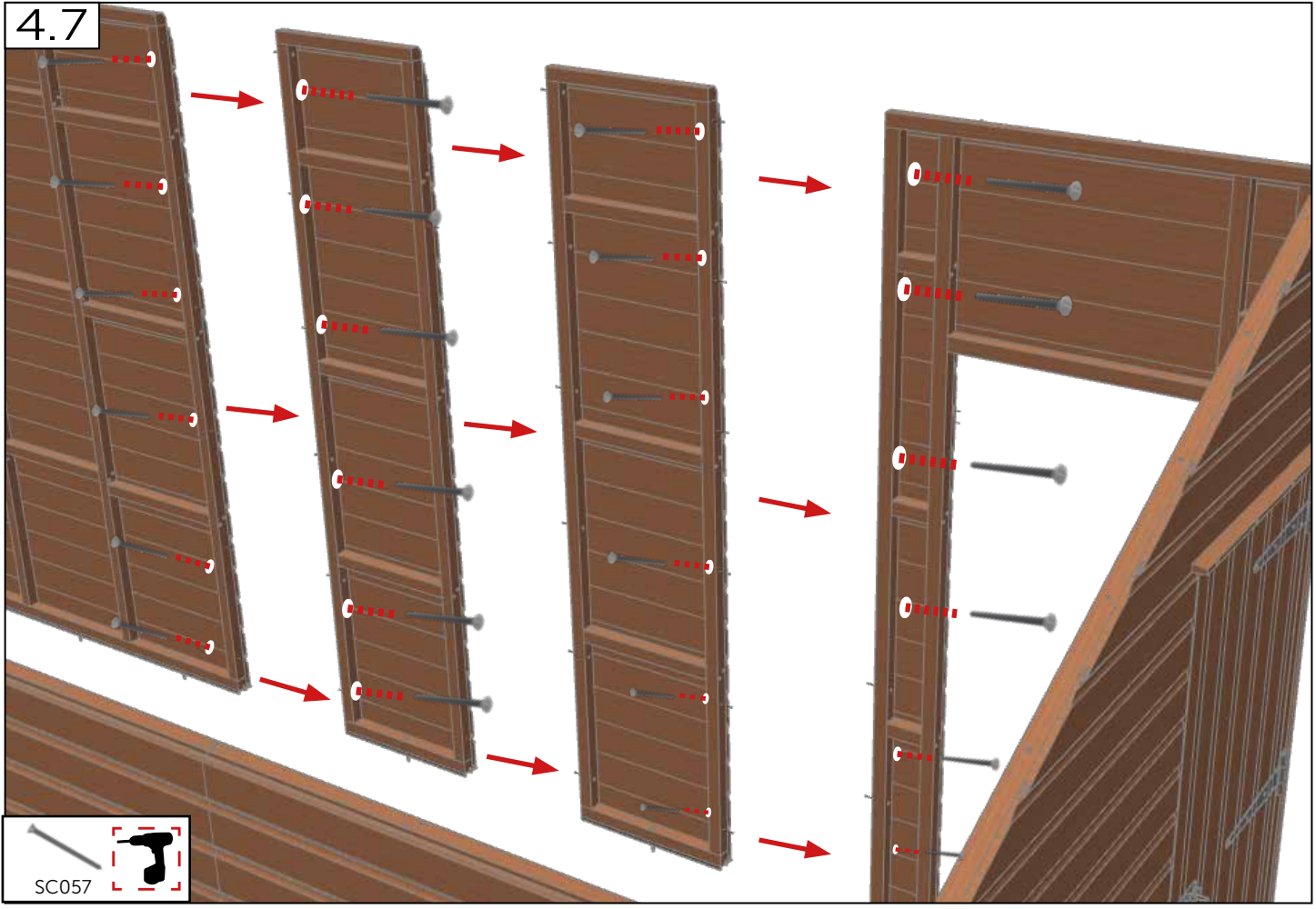

Assemble - Assembler - Montera - Montieren - Montere - Armar - Samle
 (Classic Grand Grow & Store by 10 Panel Example)

4.9

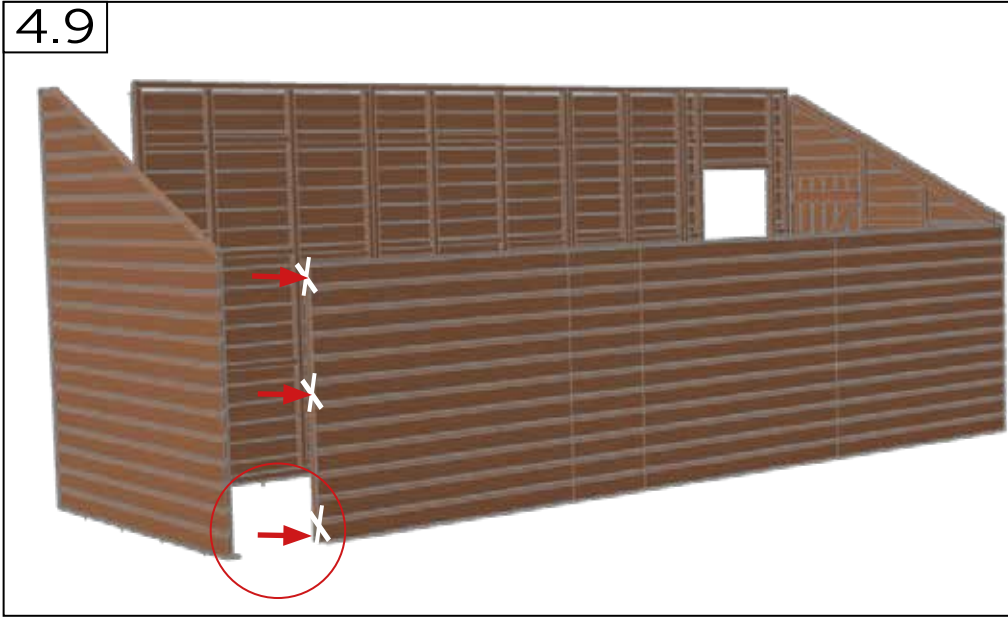

4.10

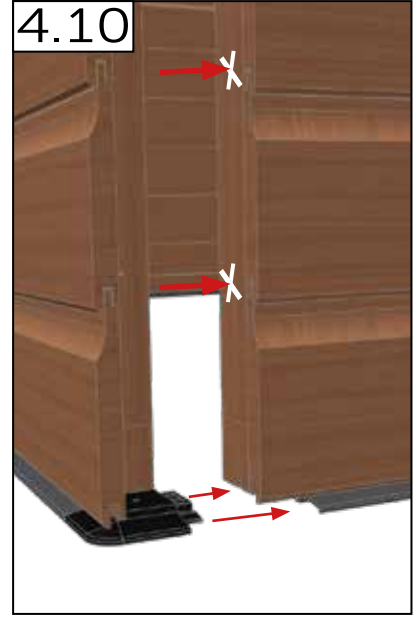

4.11

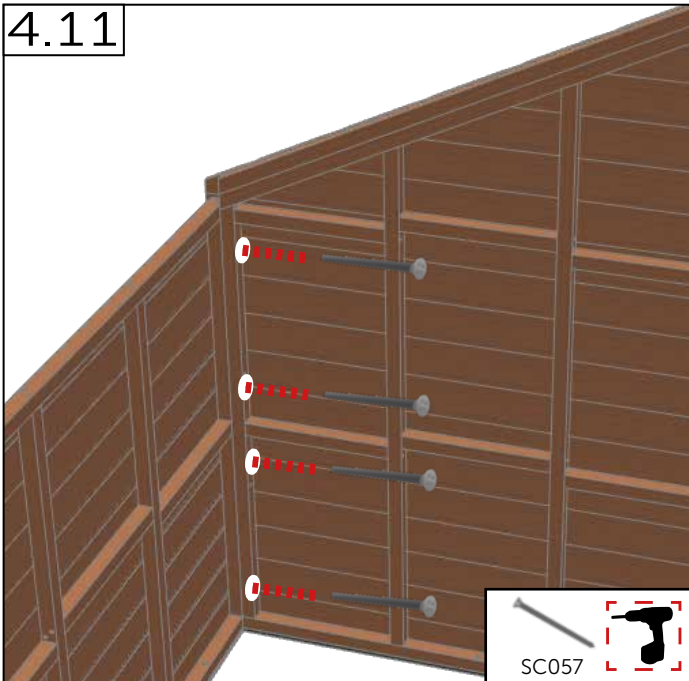

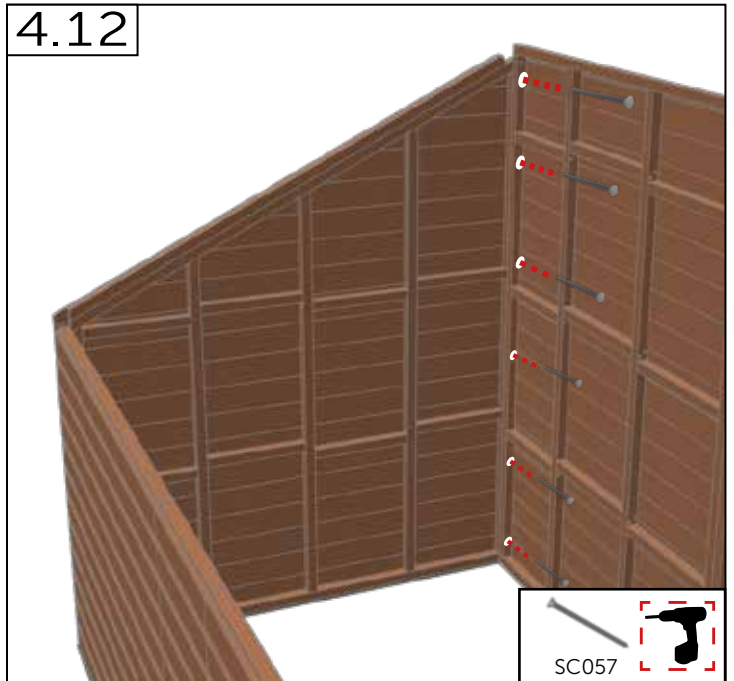

4.12

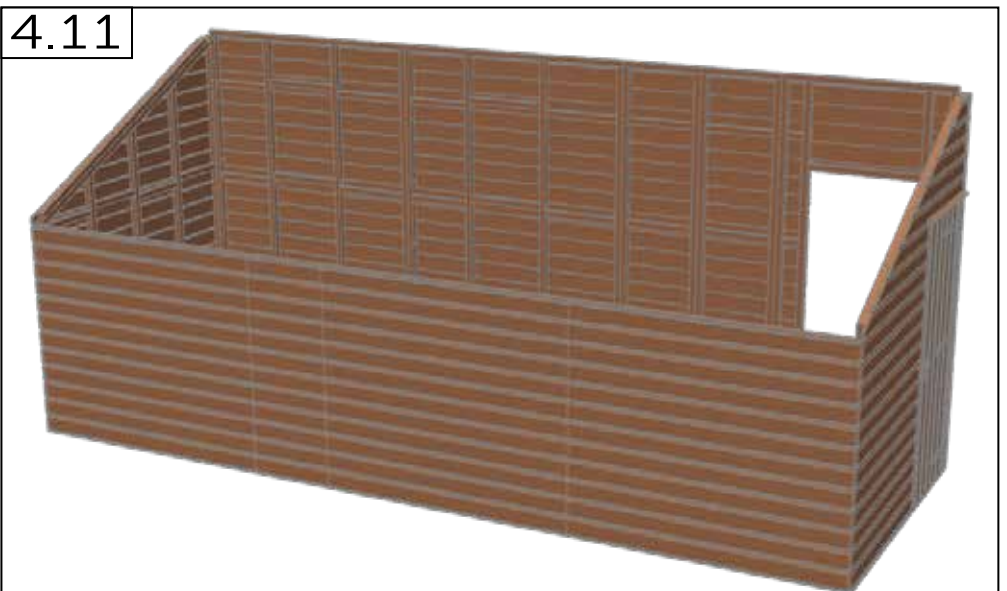

4.11



	#	mm
	SC057	4.8 x 80
	PT106	-

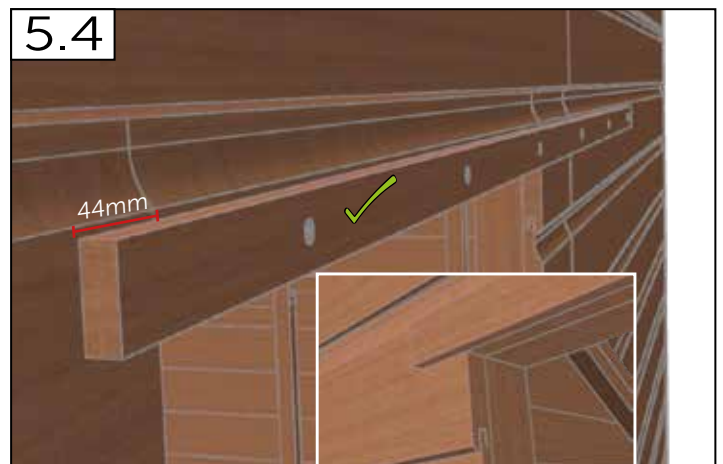
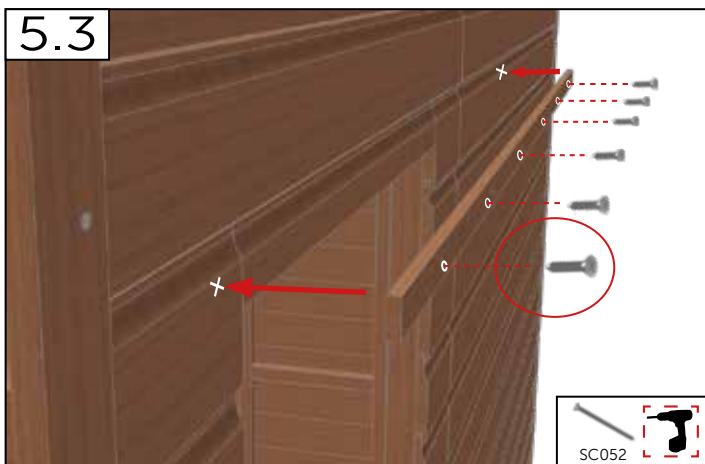
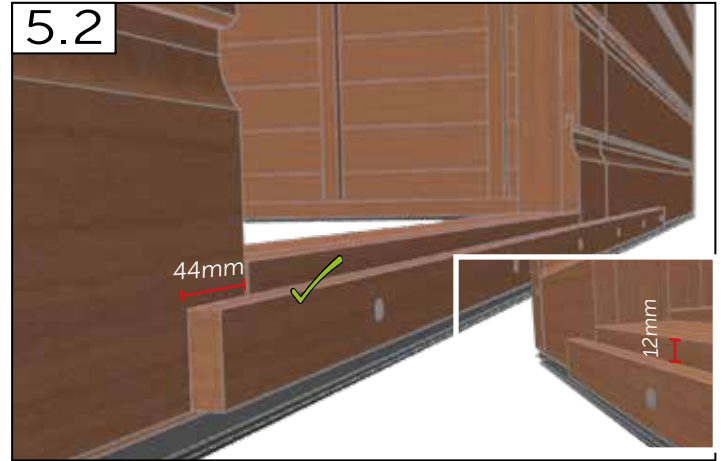
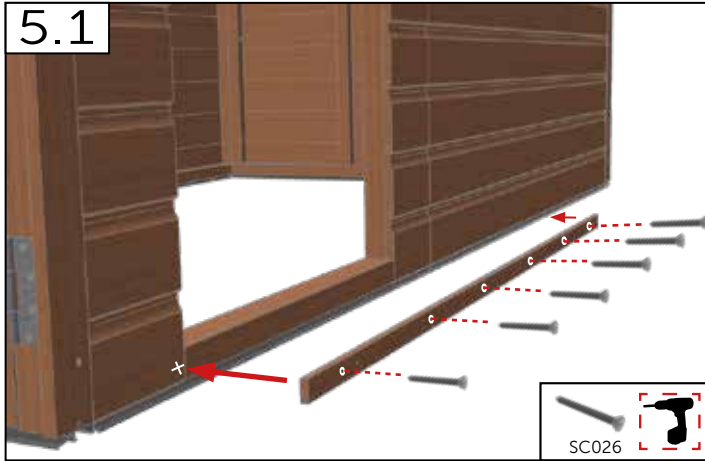



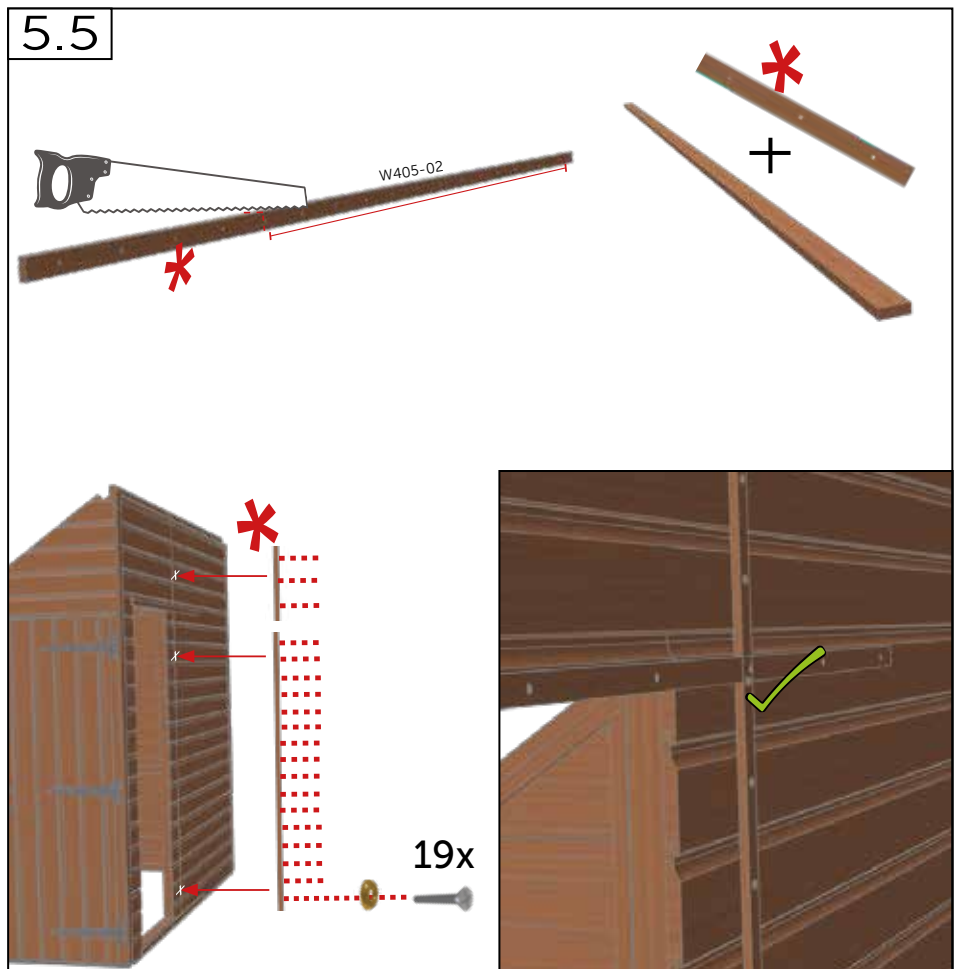

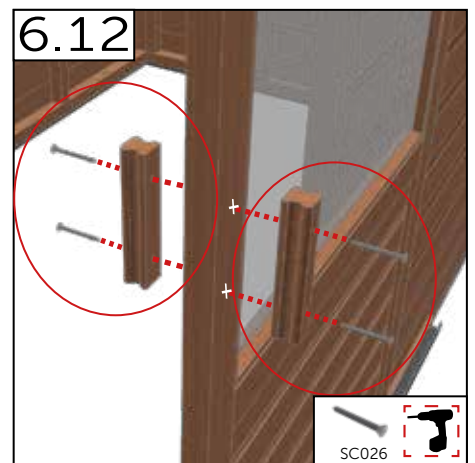
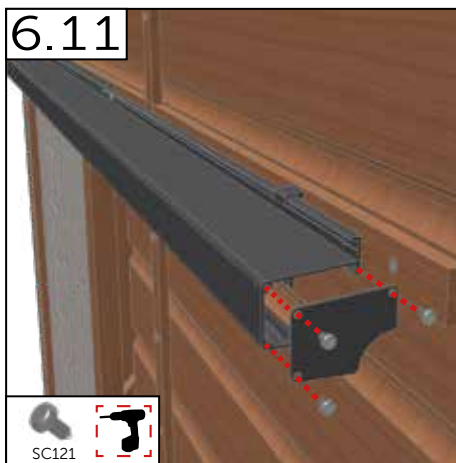
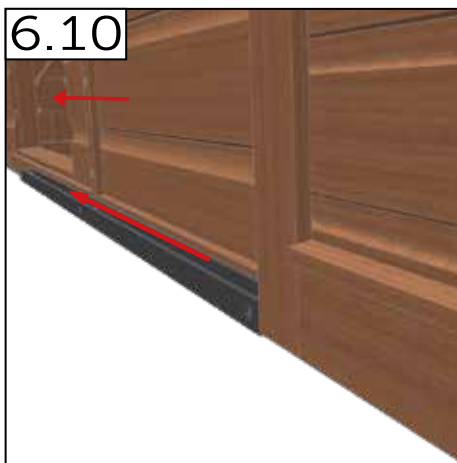
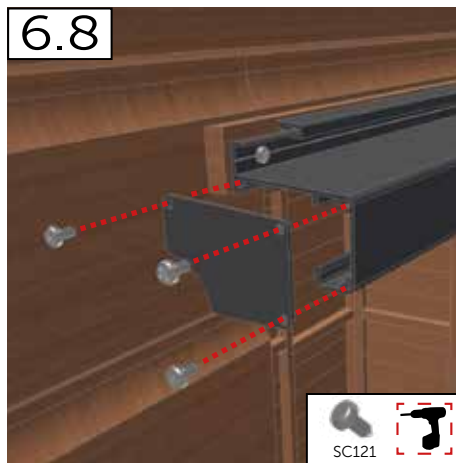
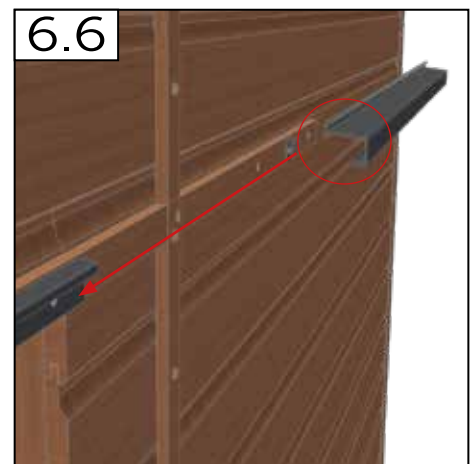
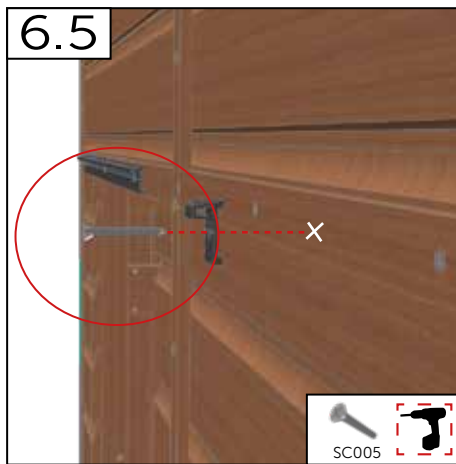
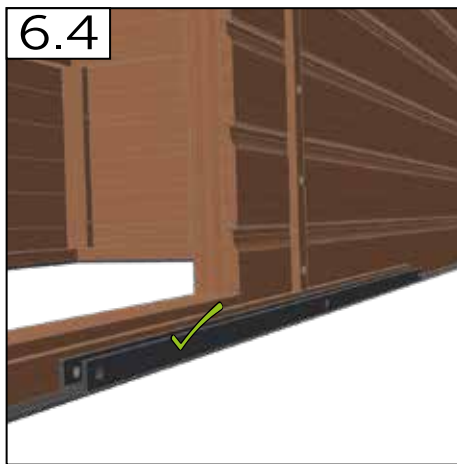
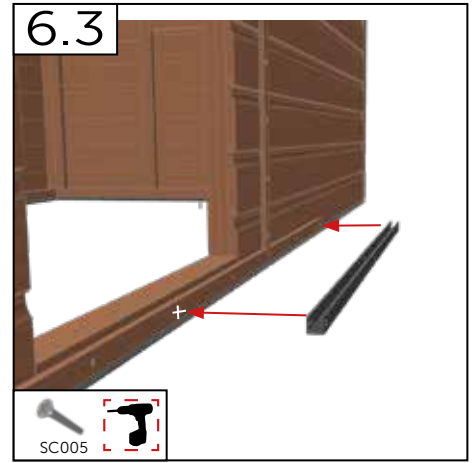
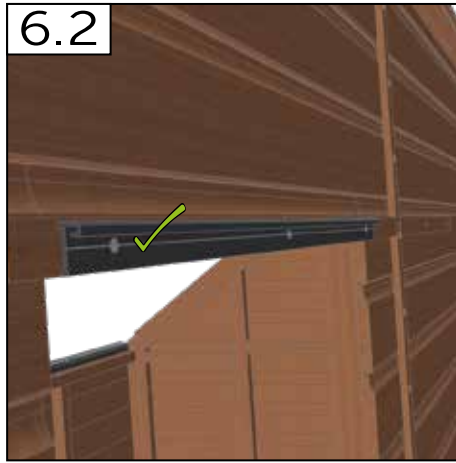
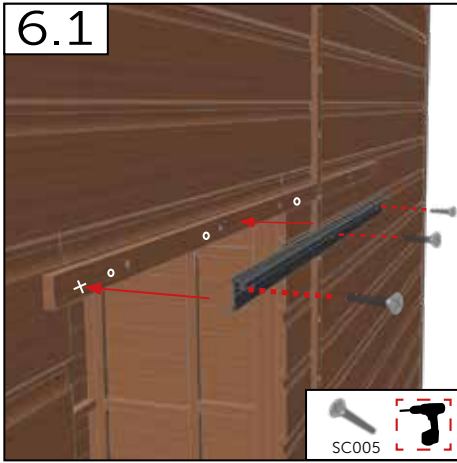





	#	mm
	W405	-
	SC026	4.2 x 50
	SC052	4.8 x 25
	SC005	3.5 x 25
	WA301	No. 8
	AL2007	-
	AL2542	1260
	AL2006	-
	SC125	4.2 x 25
	SC121	4.2 x 95
	AL3002	-





Gables-Pignons-Gavlar-Giebel-Gavler-Aguilones-Gavle

	#	mm
	SA8067	Grow & Store
	SA8068	Grow & Store
	SA8102	Grand Grow & Store
	SA8103	Grand Grow & Store
	W013-01 W013-09	-
	W013-02 W013-10	-
	W076-01 W076-03	-
	W076-02 W076-04	-
	SC024	4.2 x 38
	SC027	4.2 x 65
	WA301	No. 8

7.0

(Classic 'Grow & Store')

SA8067



SA8068

7.0

(Classic 'Grand Grow & Store')

SA8102



SA8103

7.1

(Classic 'Grow & Store')

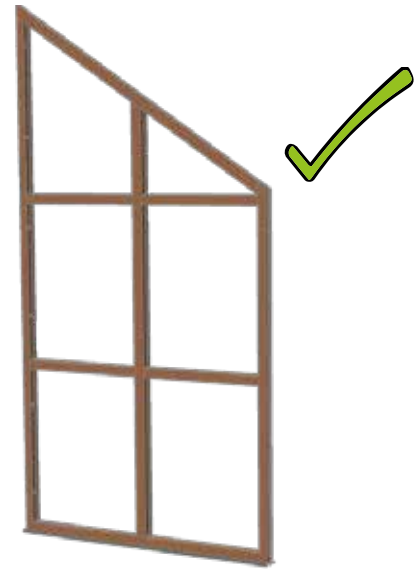
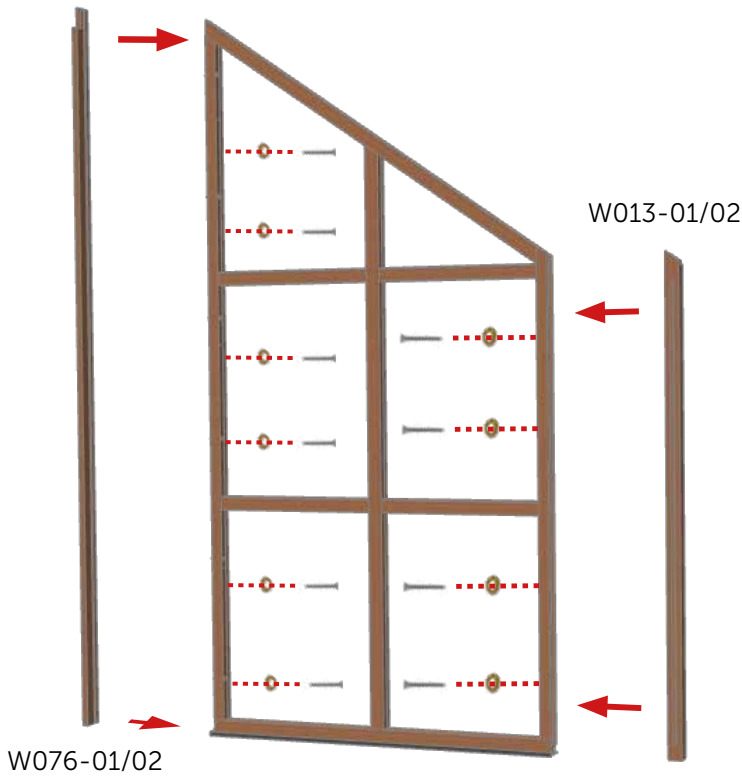

7.1

(Classic 'Grand Grow & Store')

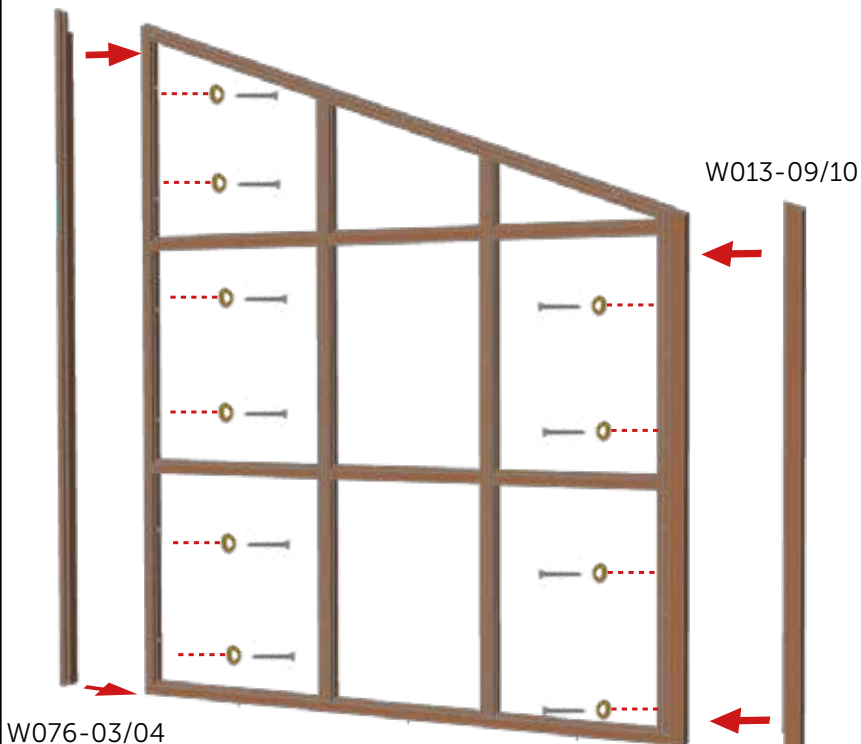

Side Panels - Des panneaux latéraux - Sidpaneler - Seitenleiste
 - Sidepaneler - Paneles laterales - Sidepaneler

8.0

2 PANEL



SA8200

3 PANEL

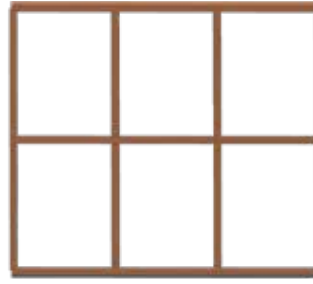

SA8201

4 PANEL

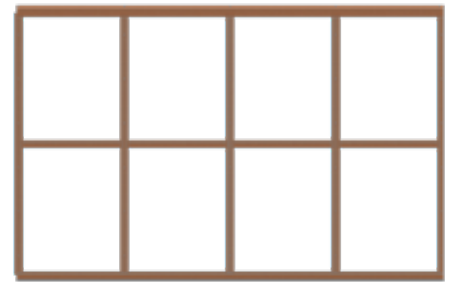

SA8202

(Classic 'Grow & Store')
 (Classic 'Grand Grow & Store')

SA8210

SA8211

SA8212

5 PANEL

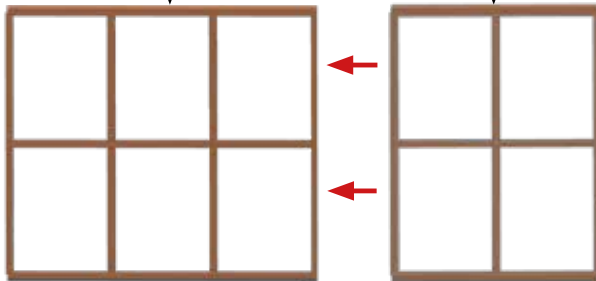

6 PANEL

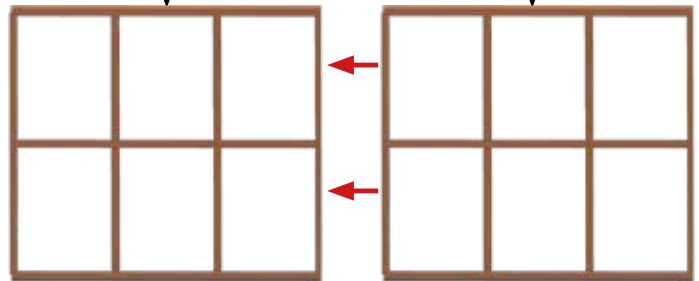

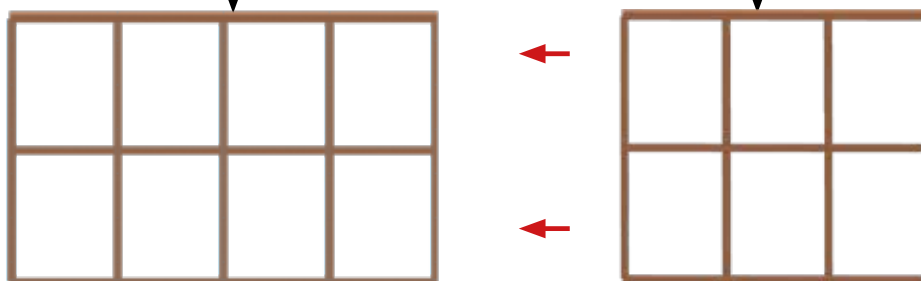

7 PANEL

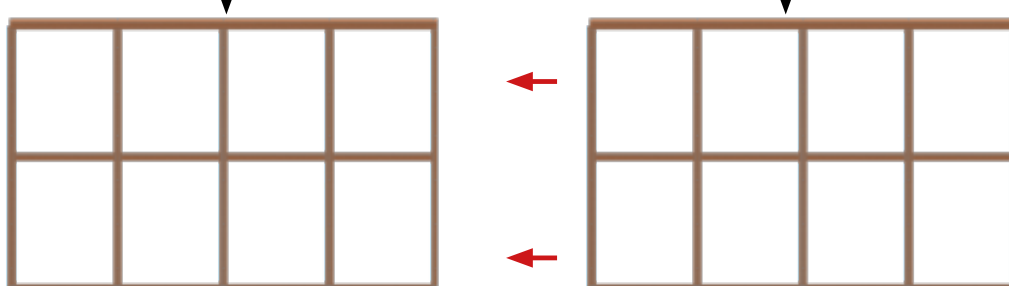

8 PANEL



	#	mm
	SC027	4.2 x 65
	SC301	No. 8

8.0

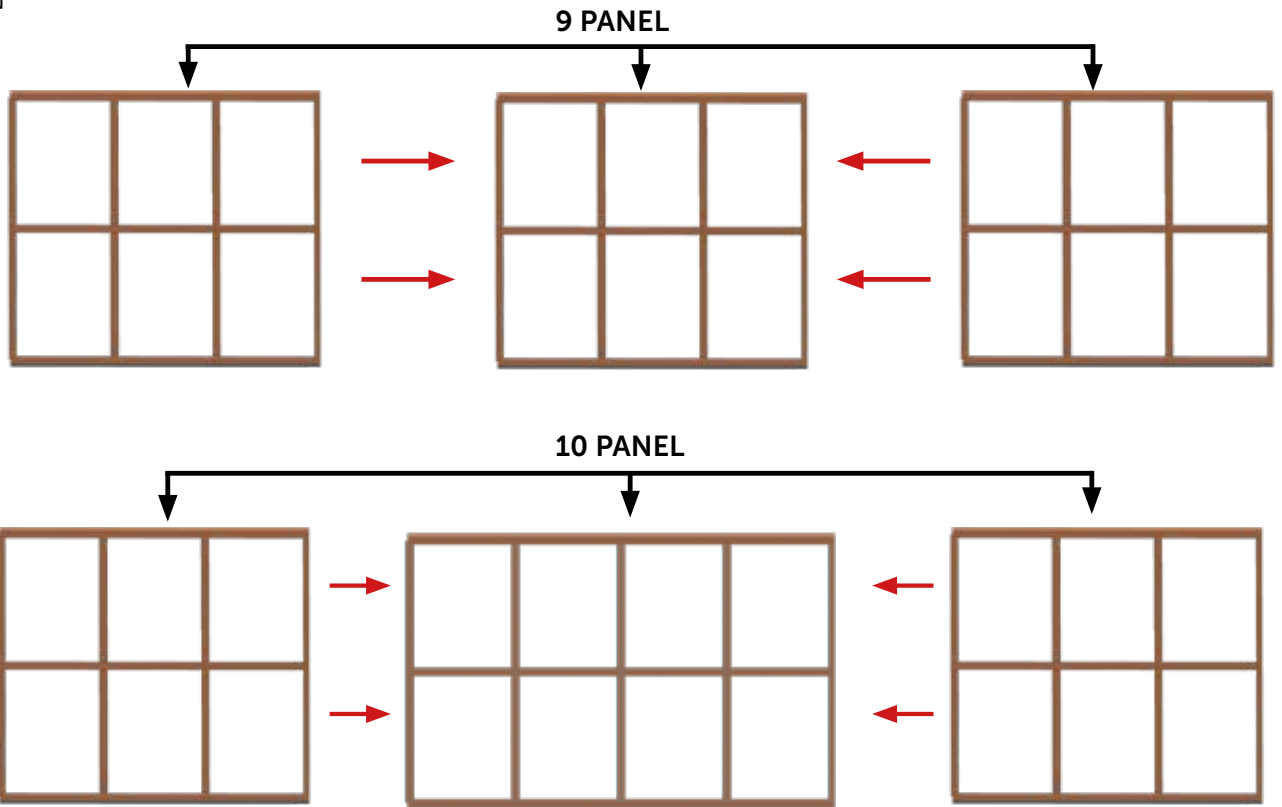

8.1

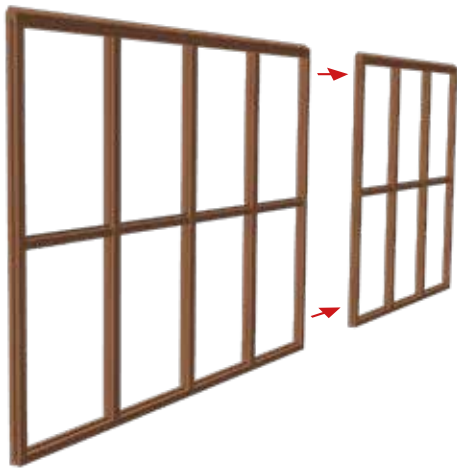

8.1

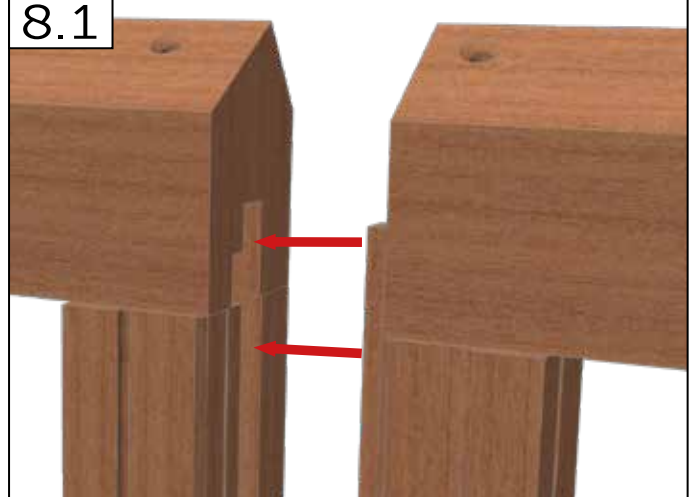

8.2



8.2

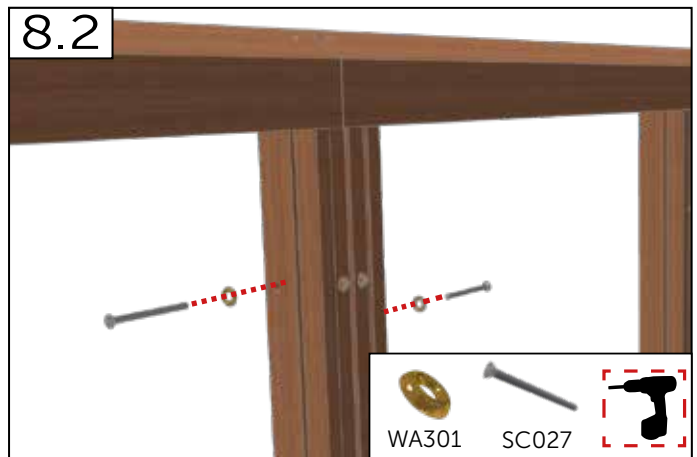

Assemble - Assembler - Montera - Montieren - Montere - Armar - Samle
(Classic 'Grand Grow & Store' only)

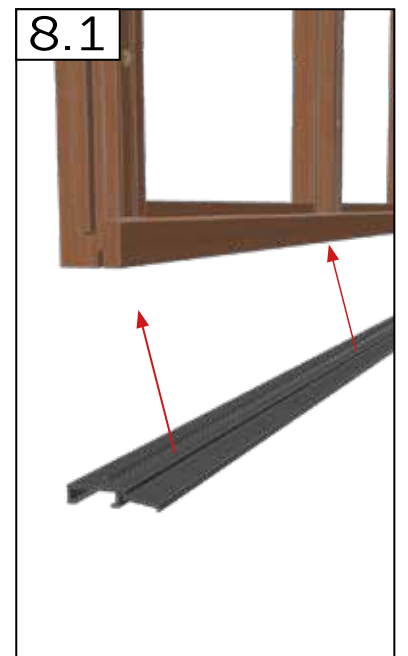
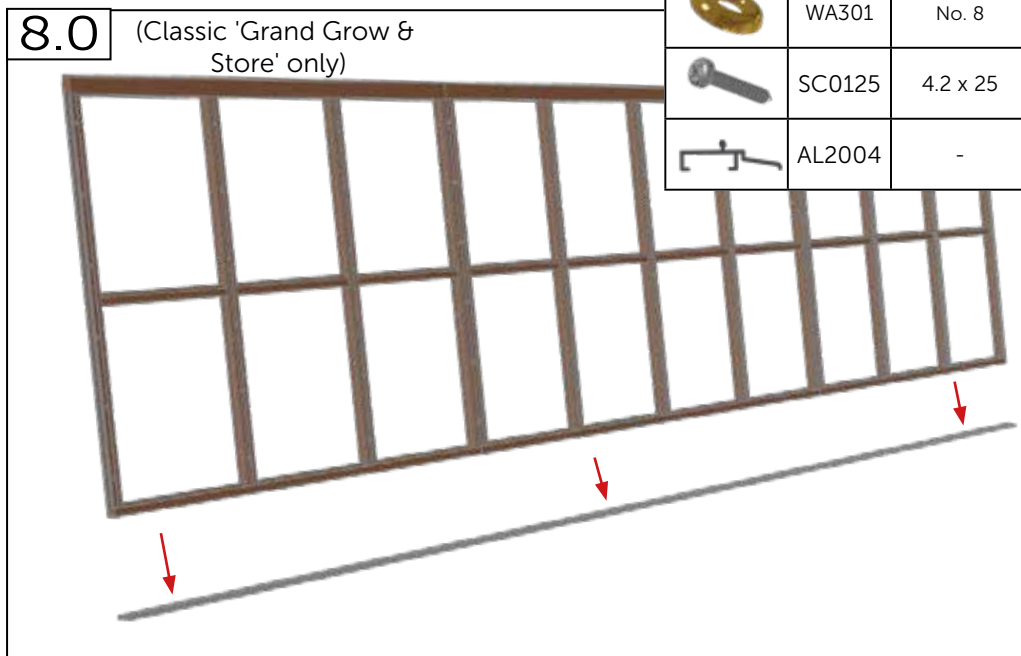
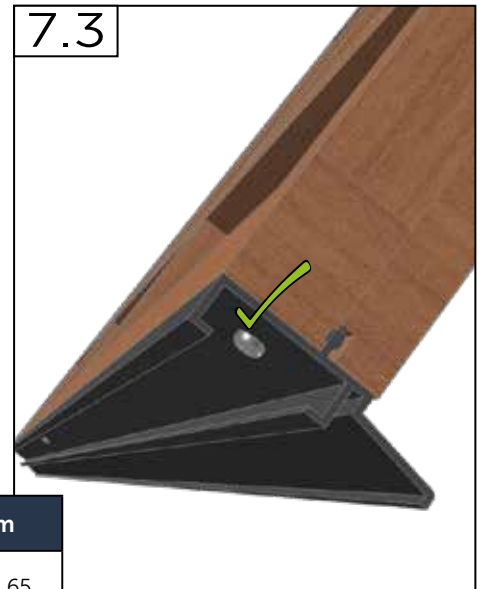
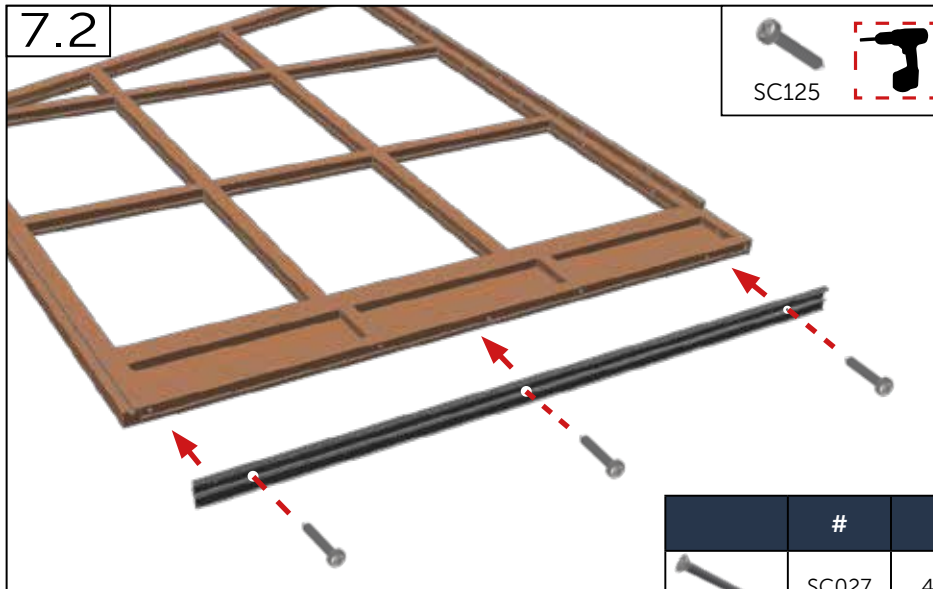
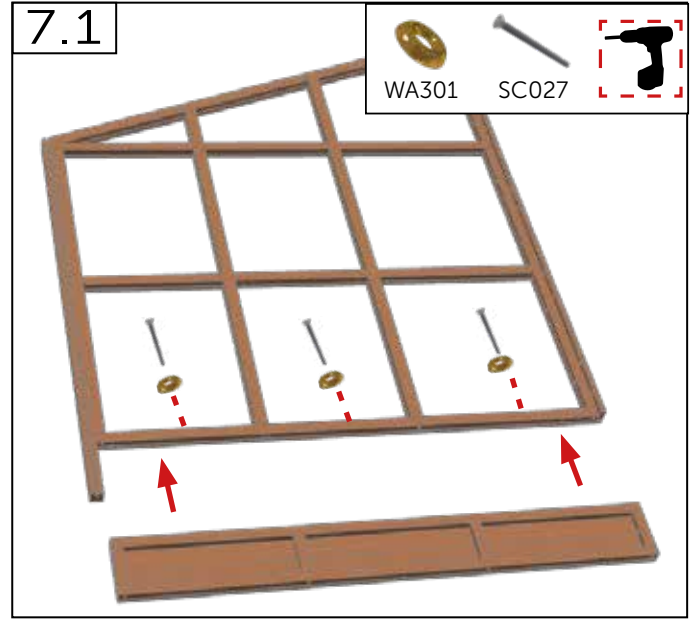
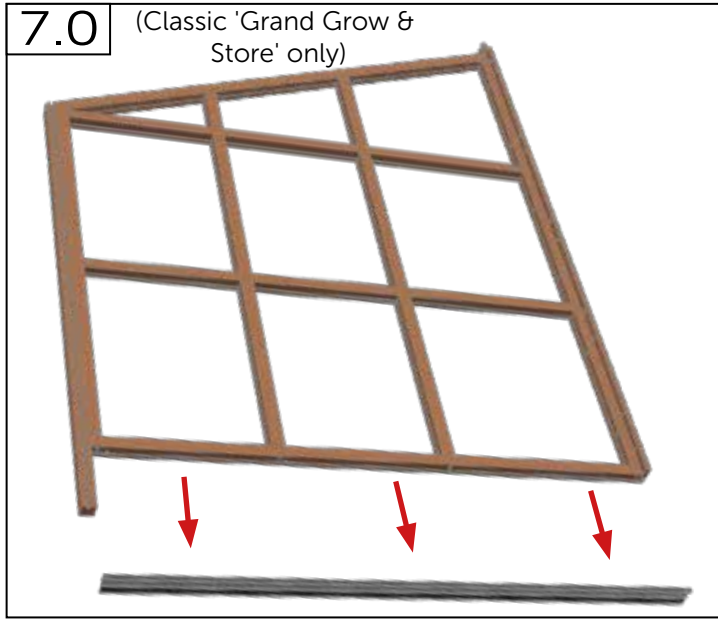

Assemble - Assembler - Montera - Montieren - Montere - Armar - Samle
(Classic 'Grand Grow & Store' only)

8.2 (Classic 'Grand Grow & Store' only)



8.3 (Classic 'Grand Grow & Store' only)

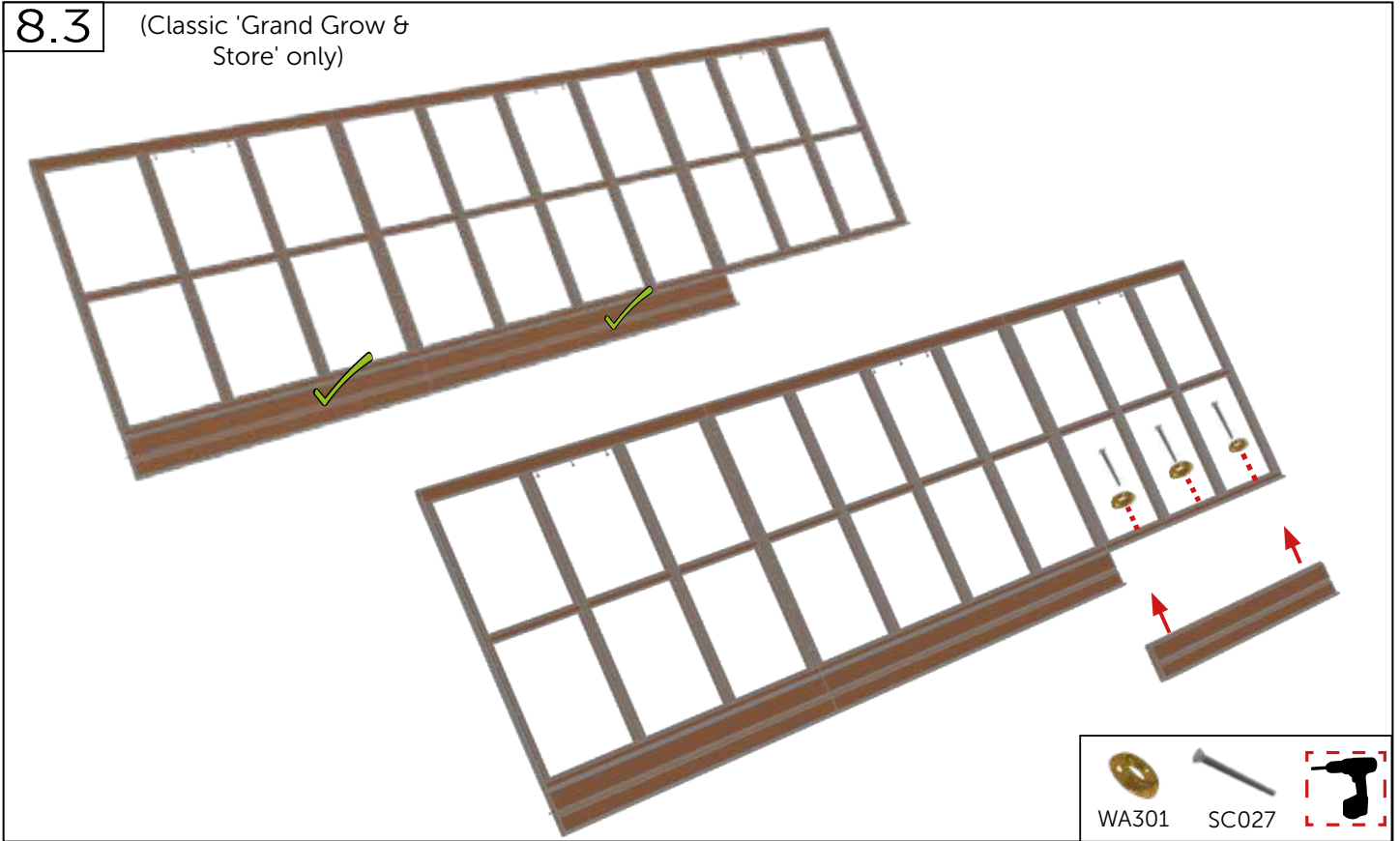

8.4 (Classic 'Grand Grow & Store' only)

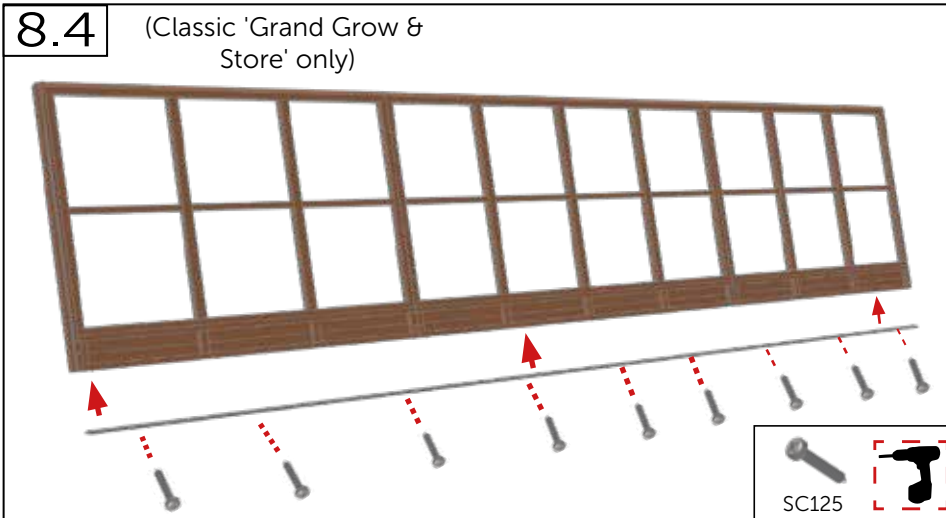

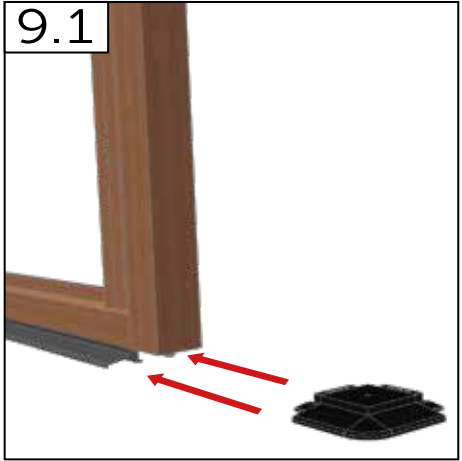
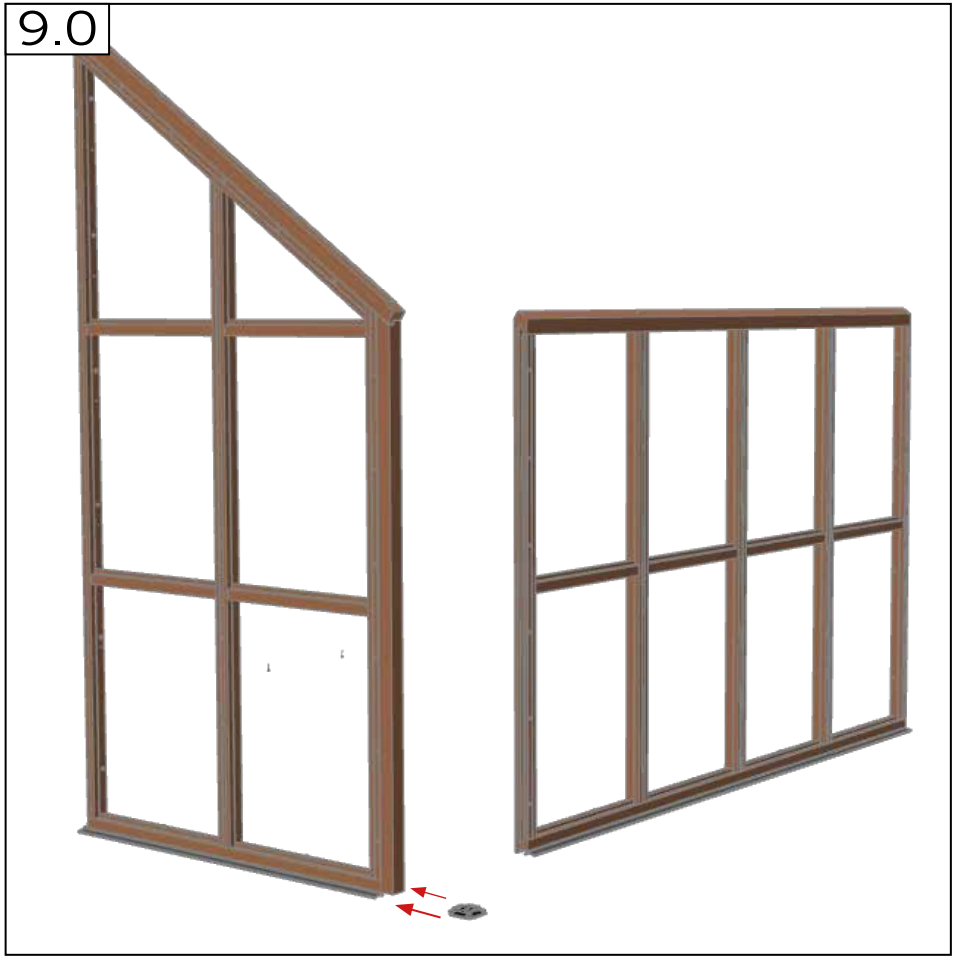

	#	mm
	PT106	-
	SC027	4.2 x 65
	WA301	No. 8

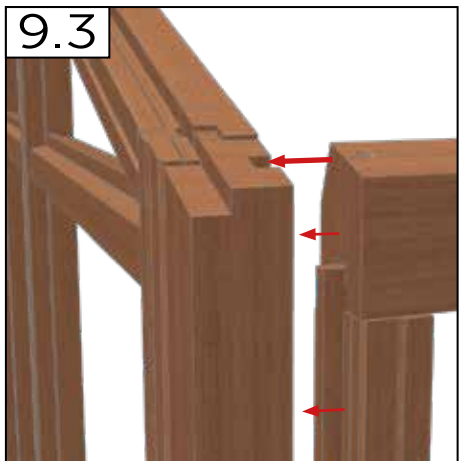
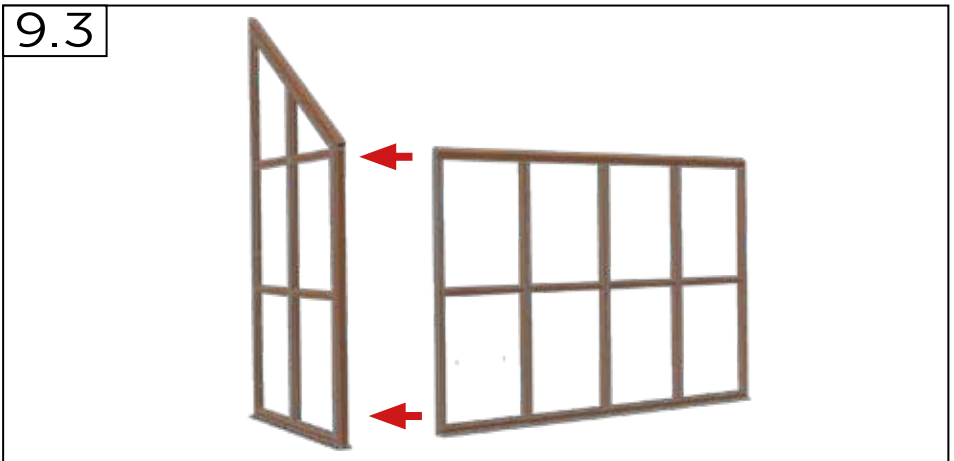

9.4

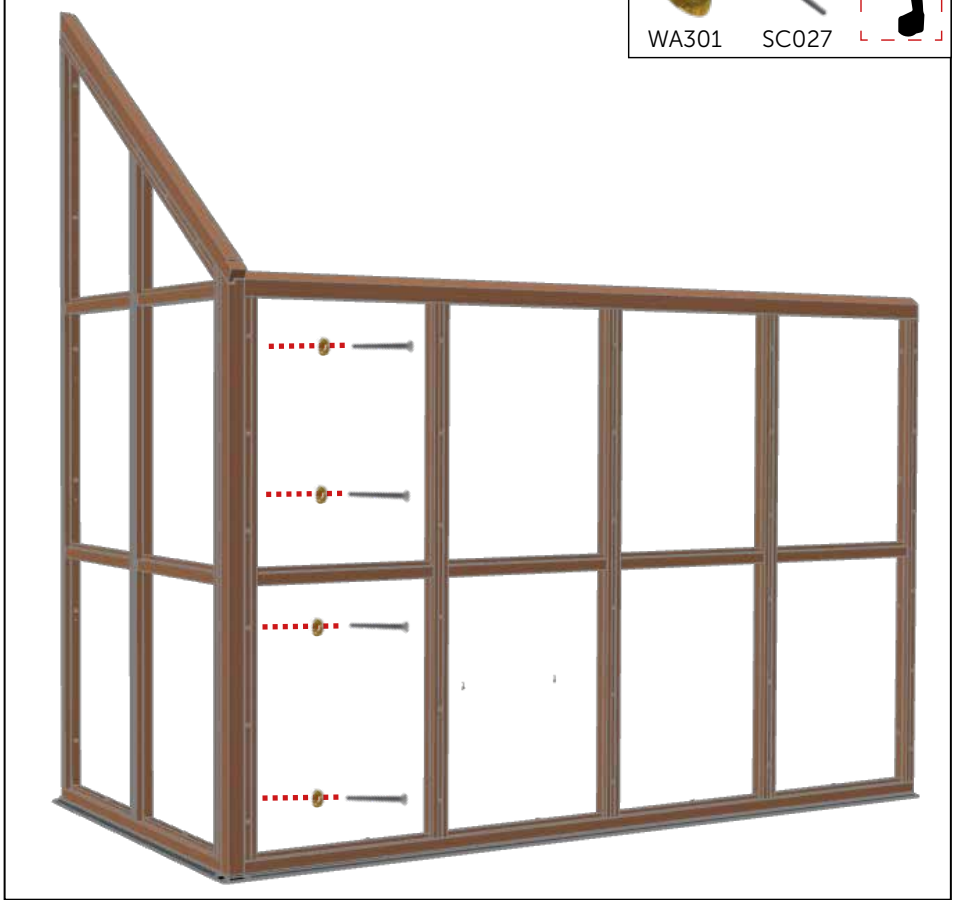
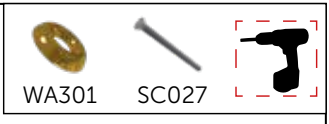

9.5

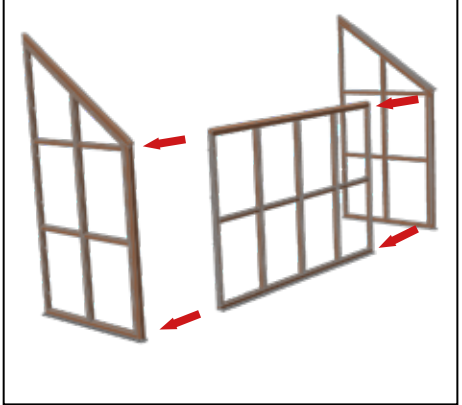

9.6

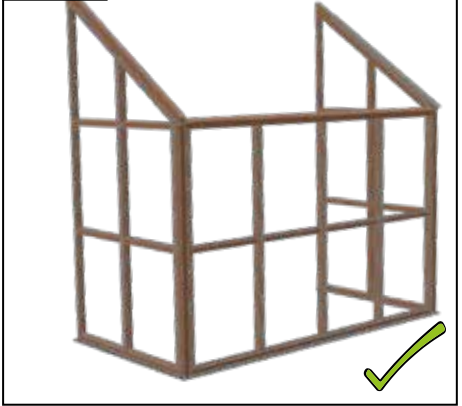

9.7

(Extension Length Only)

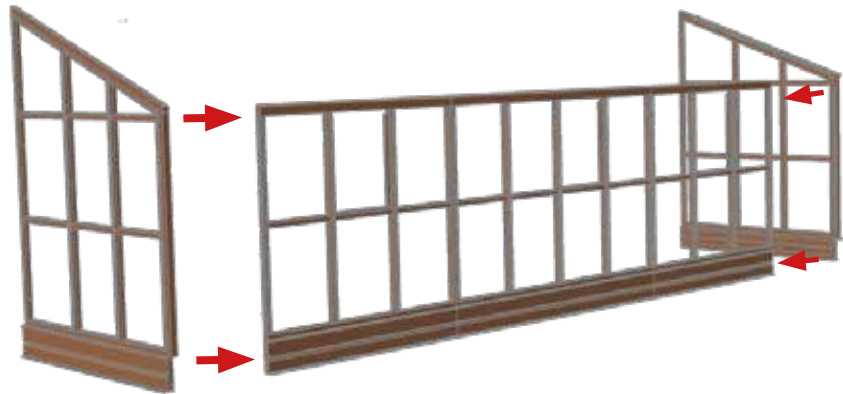

10.0

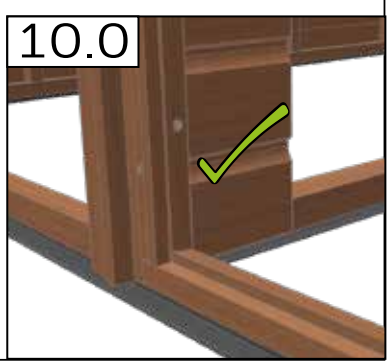
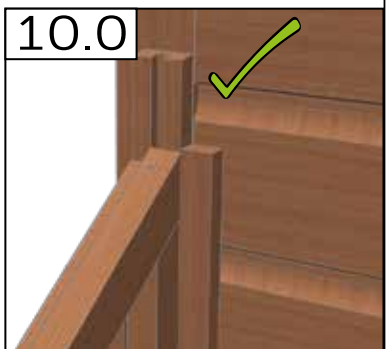
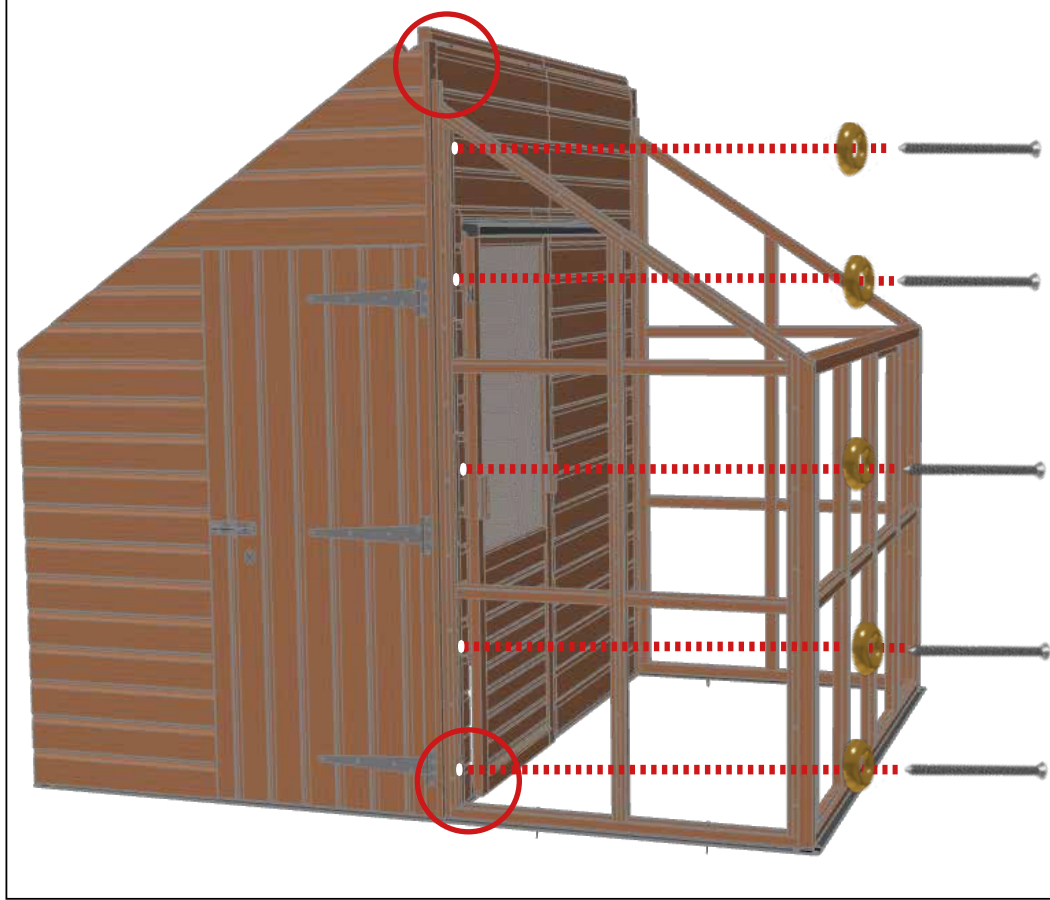

10.0

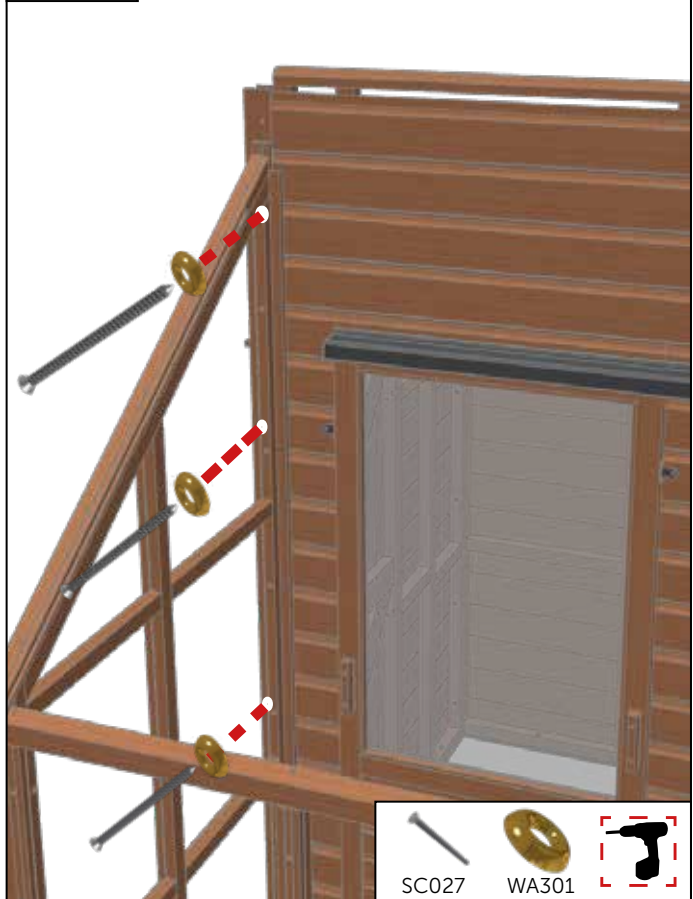

10.0

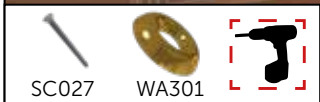
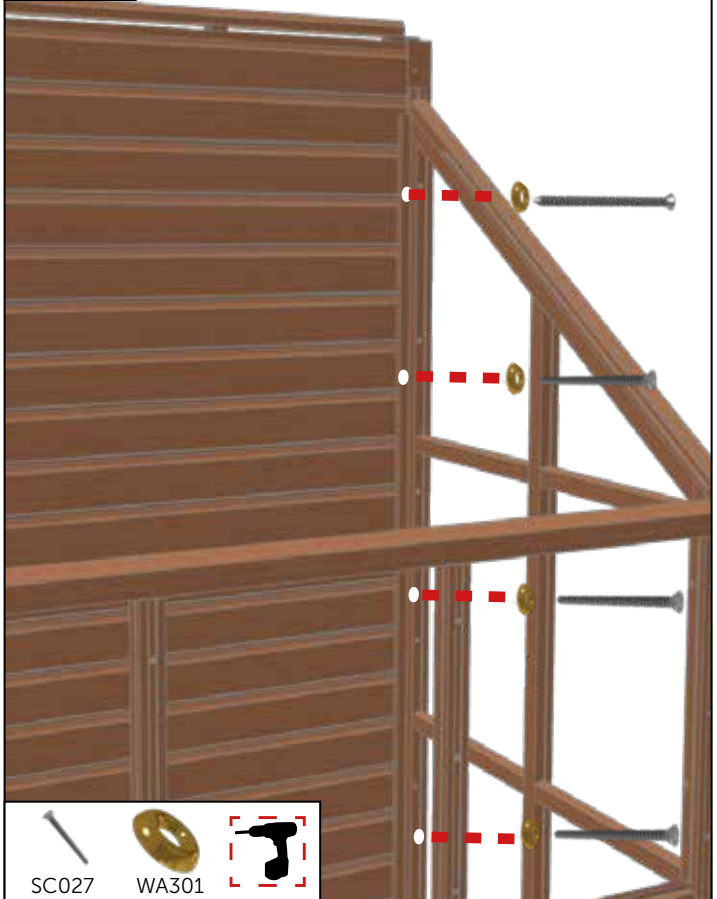

Assemble (Extension Length Only) - Assembler - Montera - Montieren
 - Montere - Armar - Samle

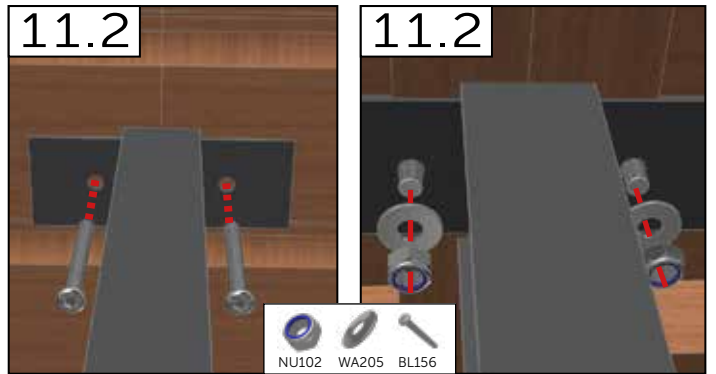
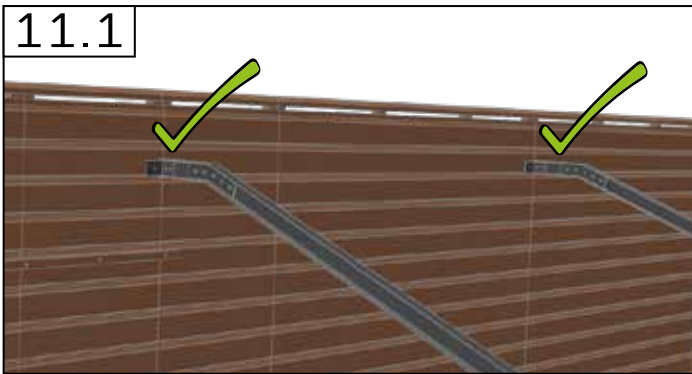
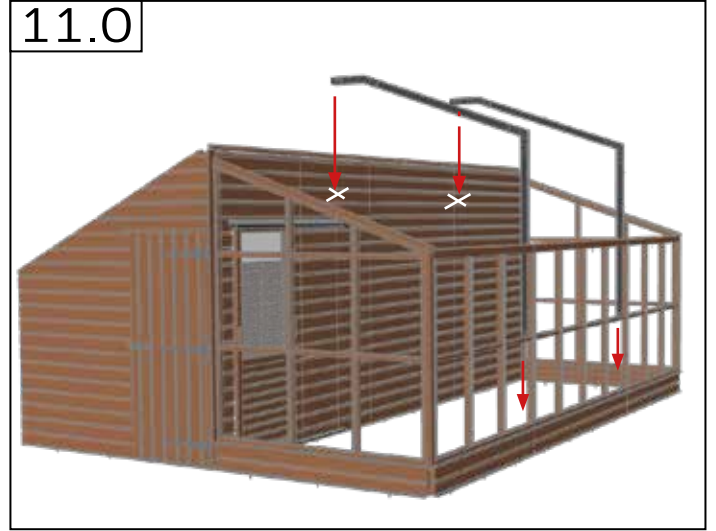
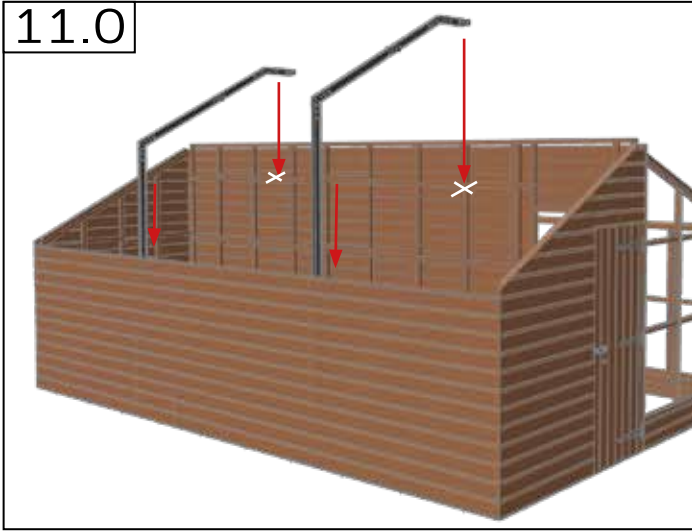

	#	mm
	-	-
	-	-
	SC125	4.2 x 25
	NU102	-
	WA205	-
	BL156	M8 x 80

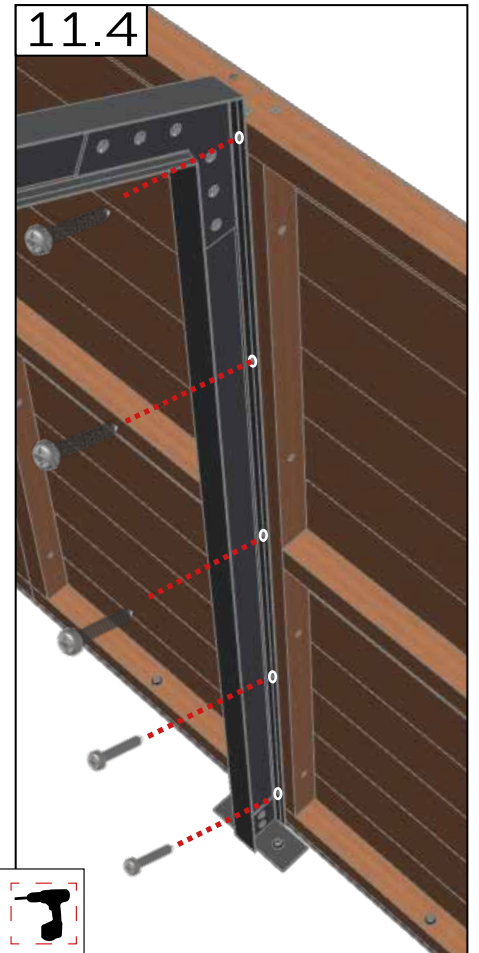
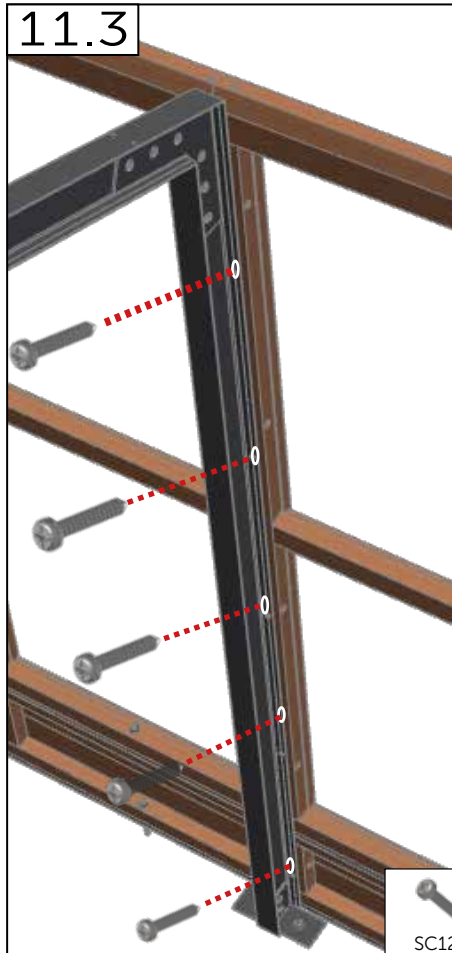

12.0

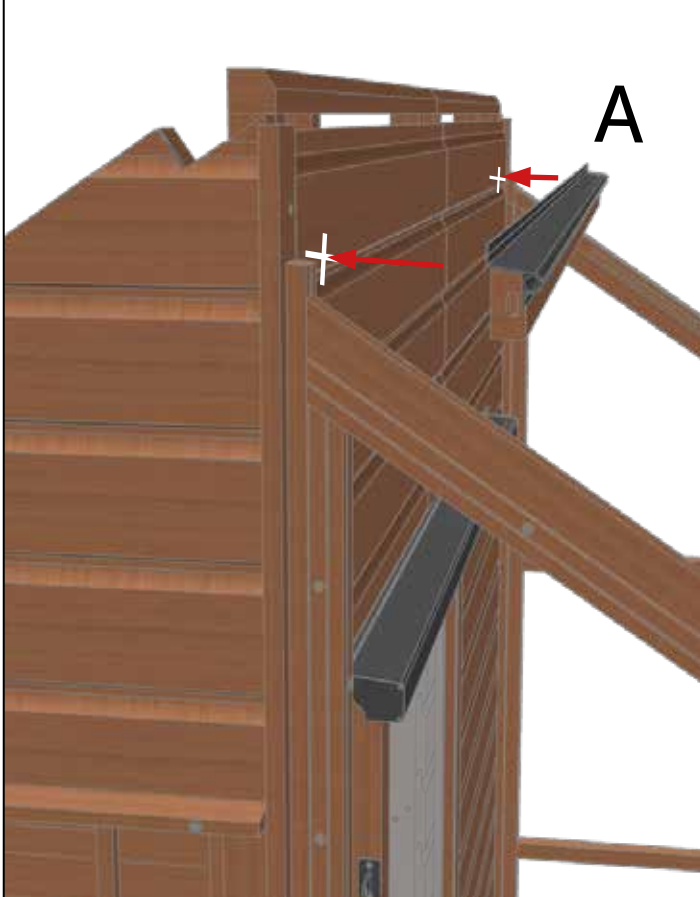

12.1

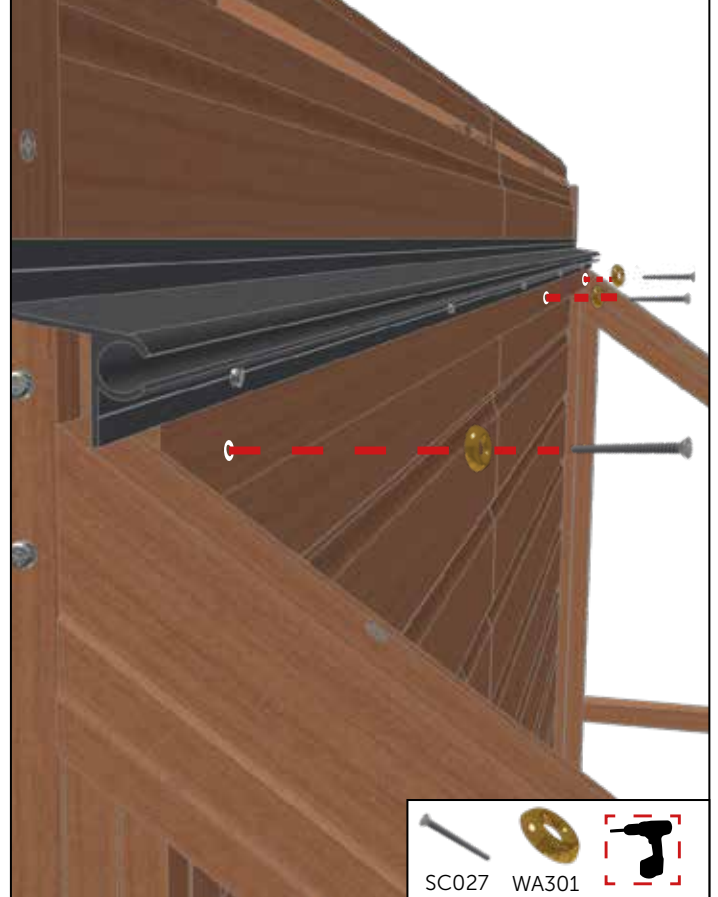

	#	mm
	A	-
	B	-
	C	-
	AD001	-
	SC027	4.2 x 65
	WA301	No 8

12.2



Assemble (Extension Length Only) - Assembler - Montera - Montieren
- Montere - Armar - Samle

12.0

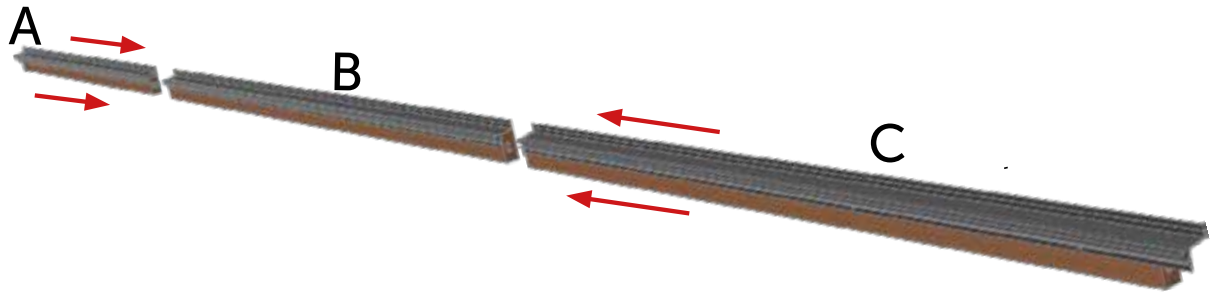

12.1

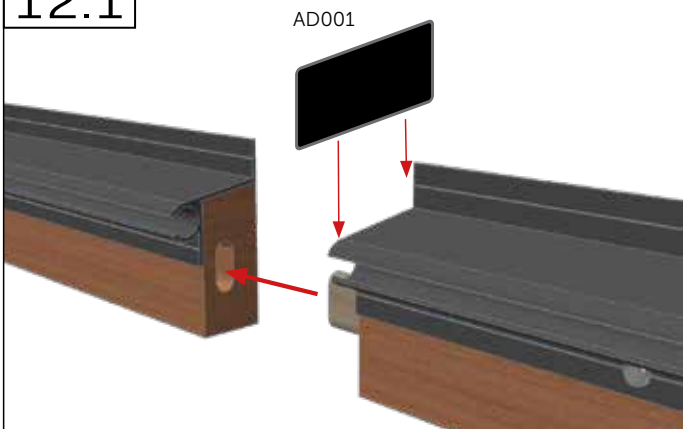

12.2

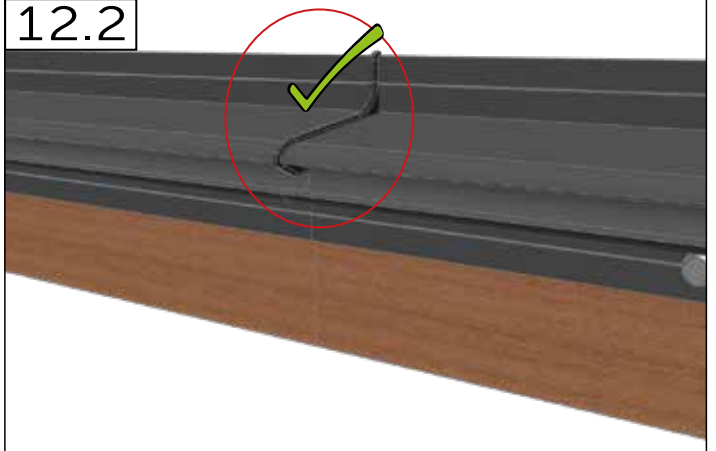

12.3

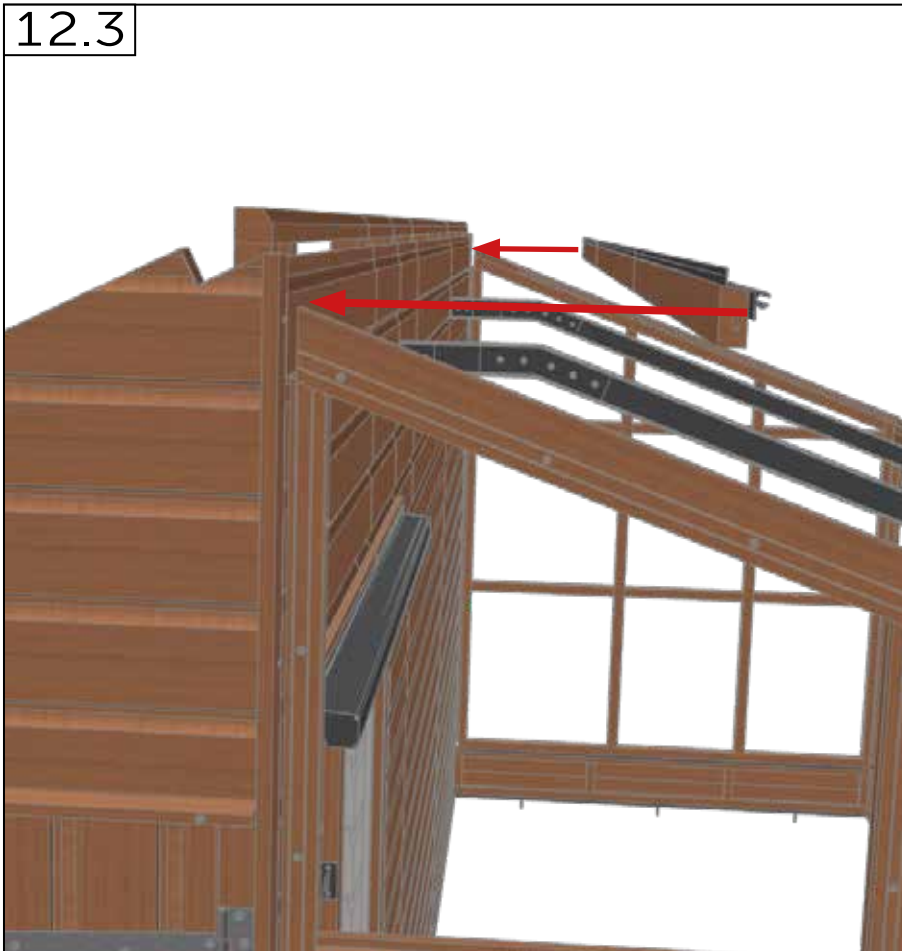

12.4



12.5



Assemble - Assembler - Montera - Montieren - Montere - Armar - Samle
(Classic 'Grand Grow & Store' only)

13.0

(Classic 'Grand Grow & Store' only)

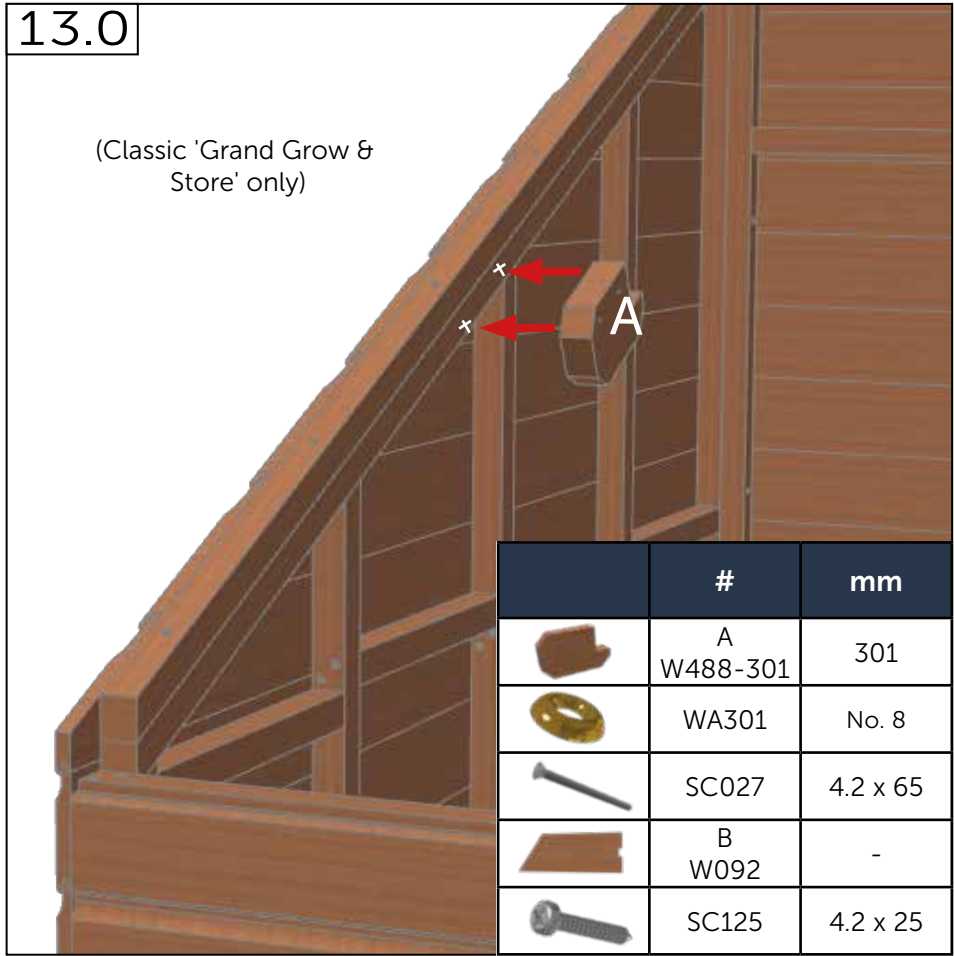

	#	mm
	A W488-301	301
	WA301	No. 8
	SC027	4.2 x 65
	B W092	-
	SC125	4.2 x 25

13.1

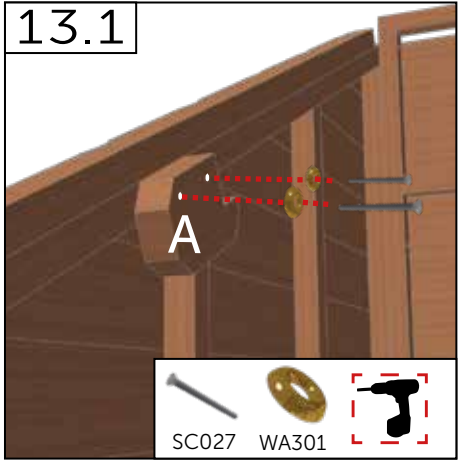

13.2

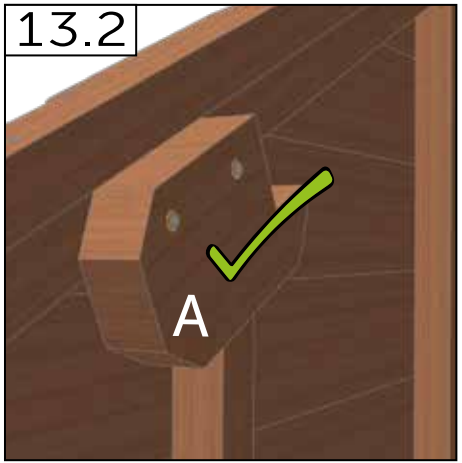

13.3

(Classic 'Grand Grow & Store' only)

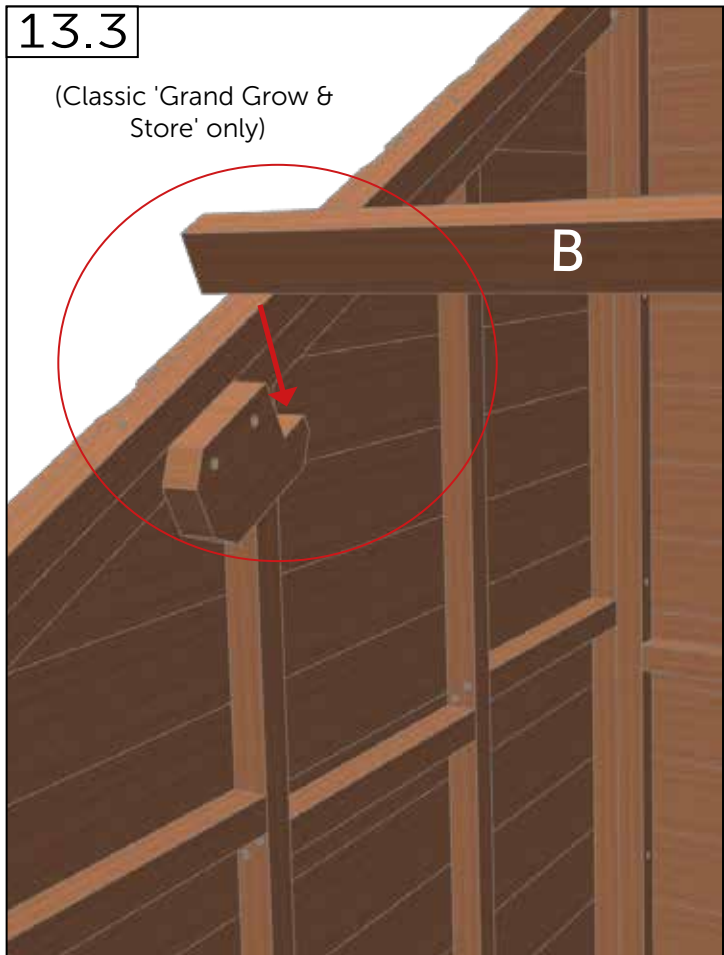

13.3

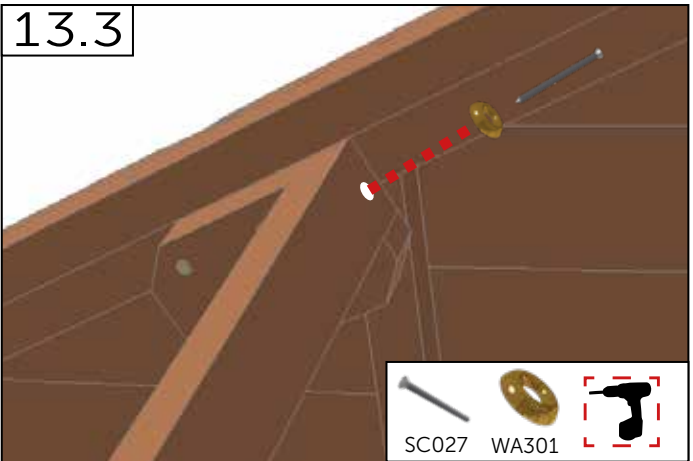

13.3

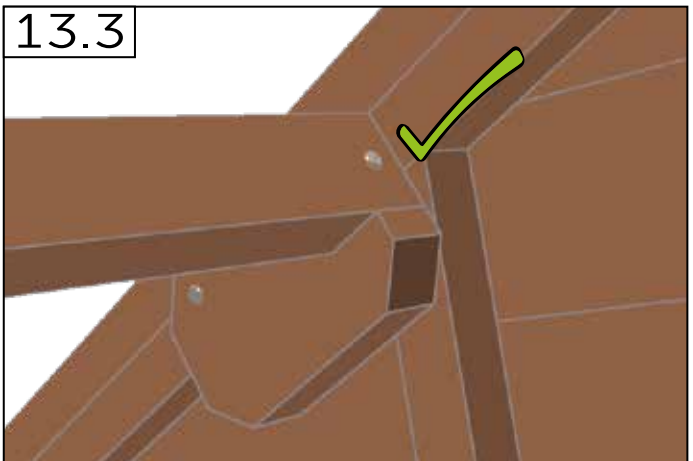

Assemble (Extension Length Only)- Assembler - Montera - Montieren - Montere -
Armar - Samle (Classic 'Grand Grow & Store' only)

13.4

(Classic 'Grand Grow & Store' only)

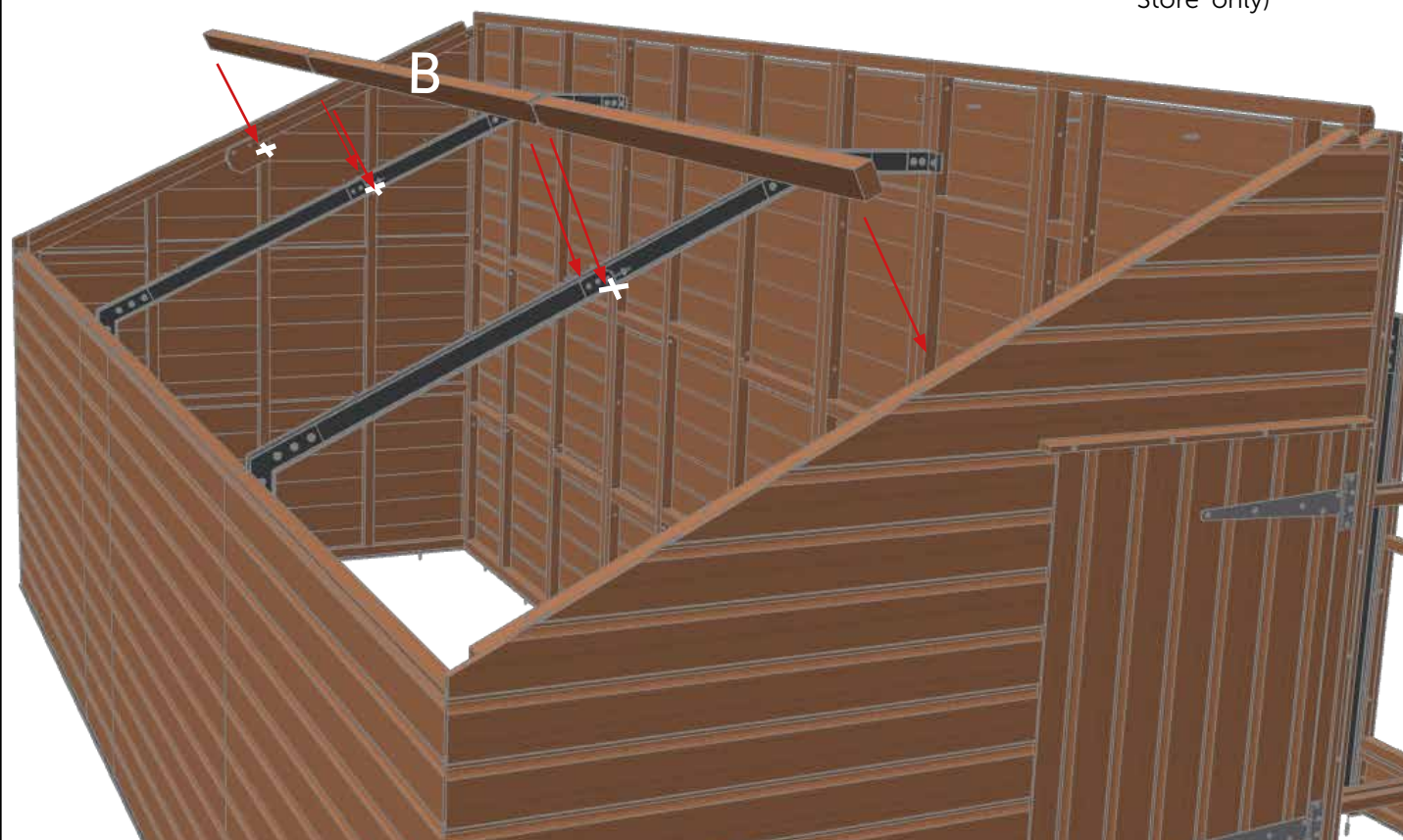

	#	mm
	B W093	-
	BL155	M8 x 70
	WA205	M8
	NU102	-
	W433	-
	SC026	4.2 x 50
	SC057	

13.5

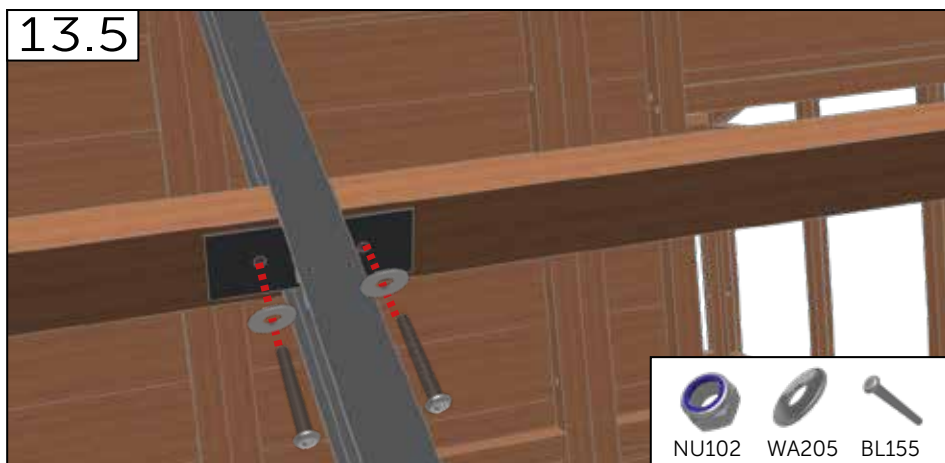

13.6

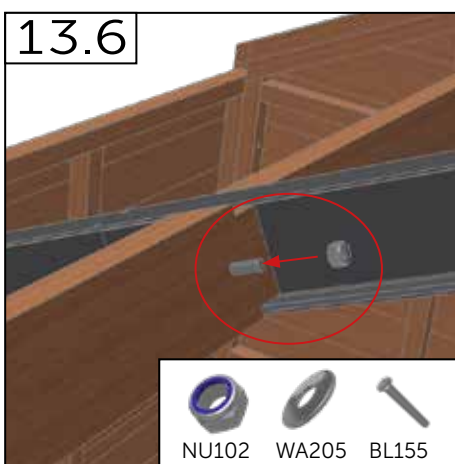

13.7

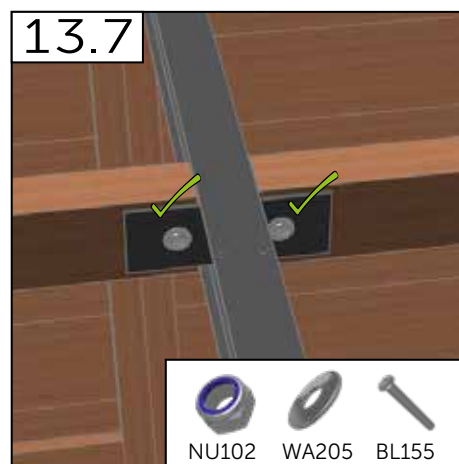

14.0

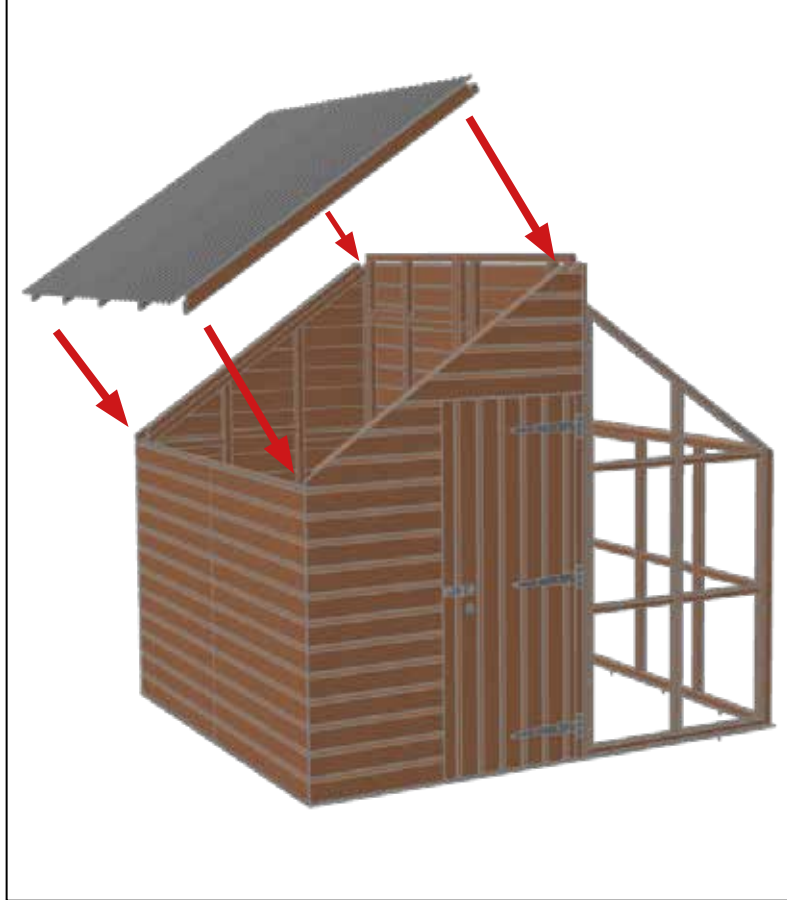

14.1

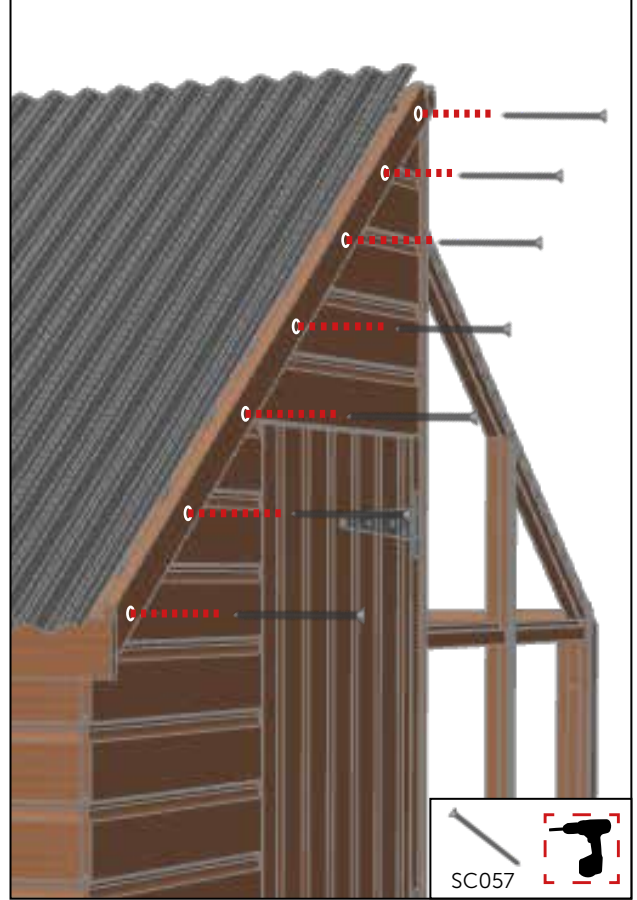

14.2

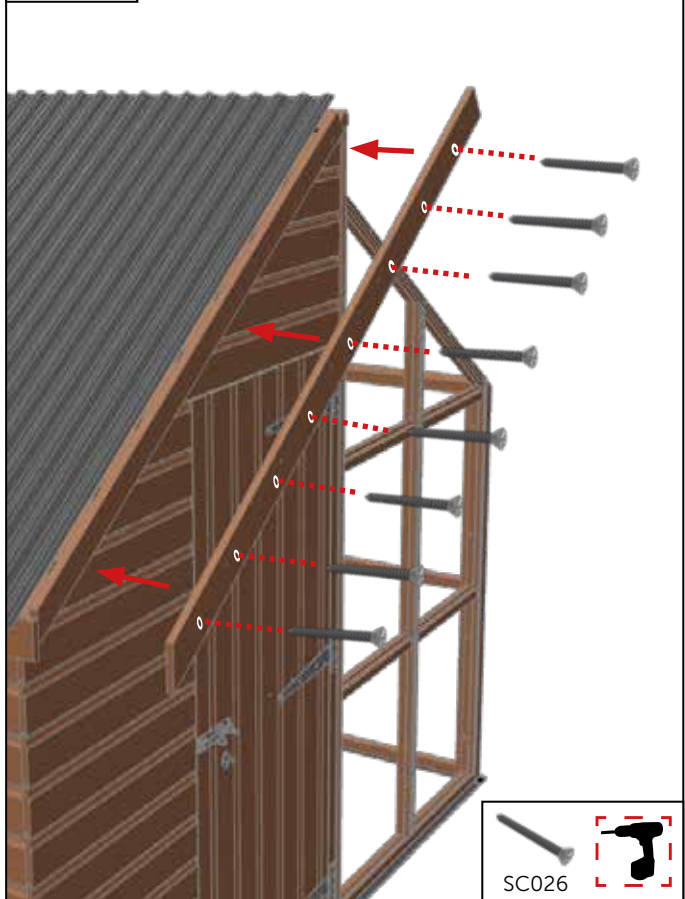

14.3

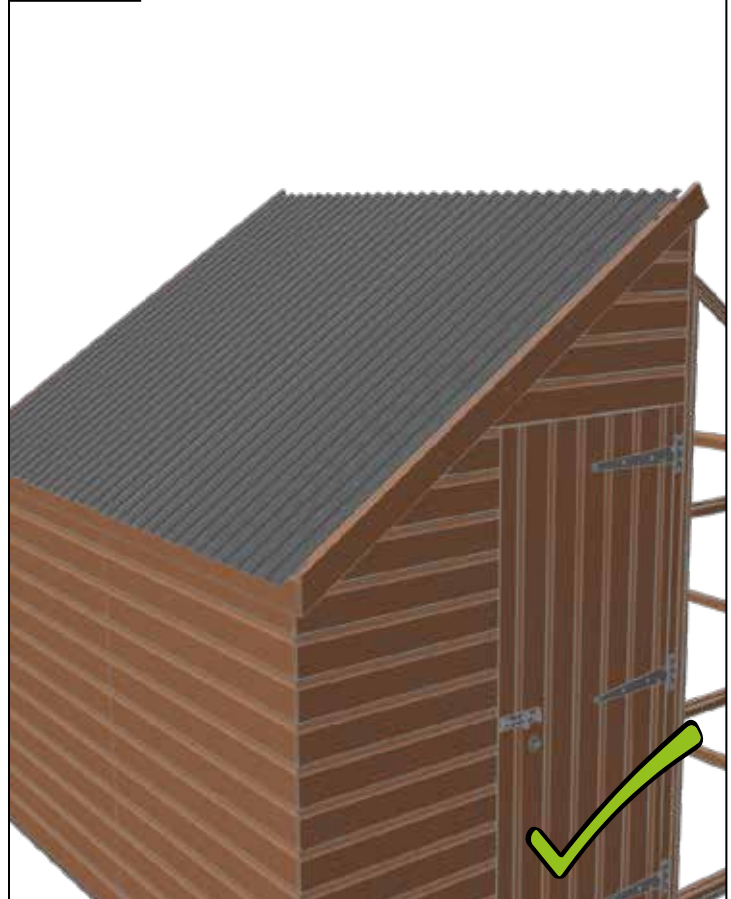

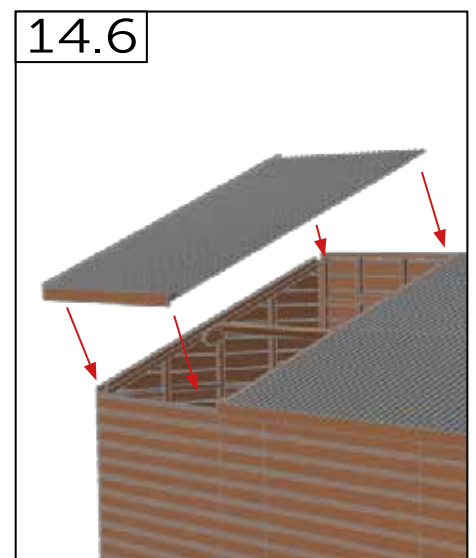
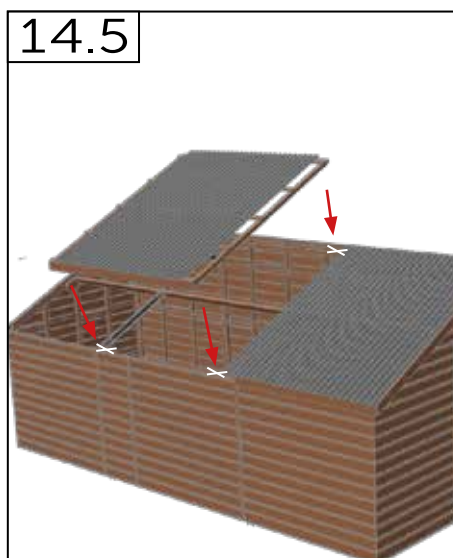
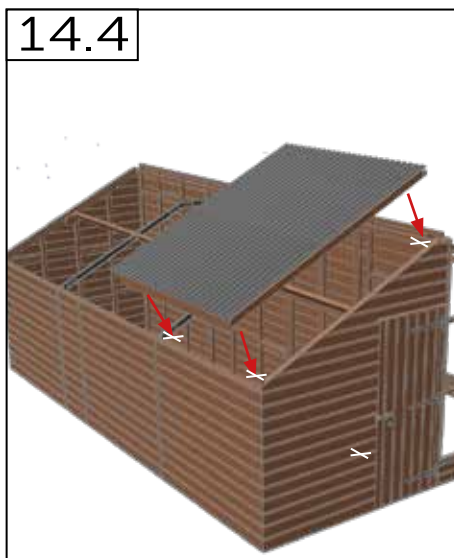
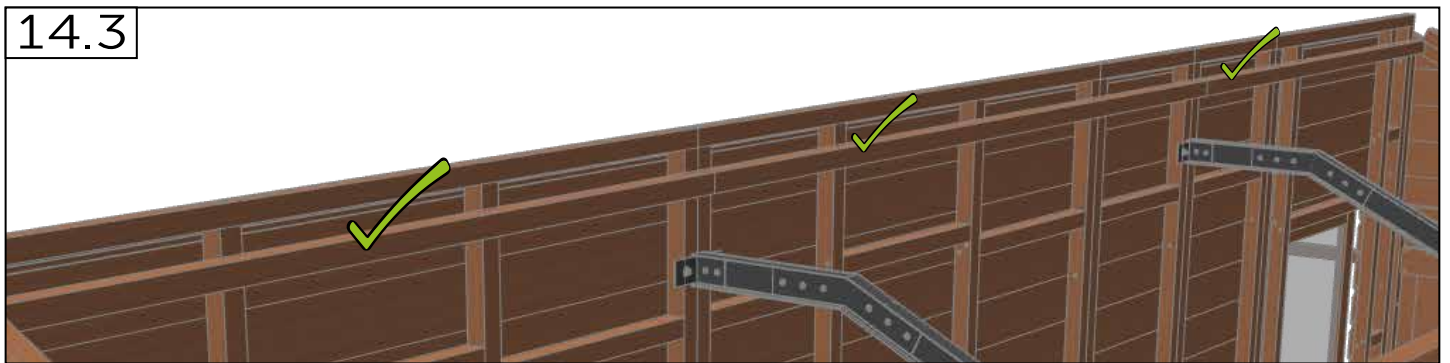
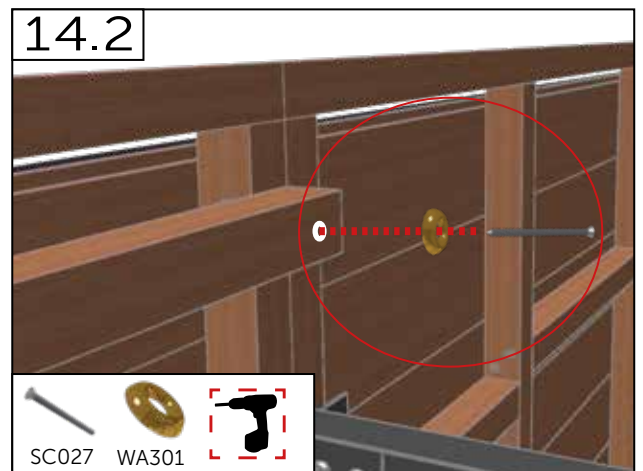
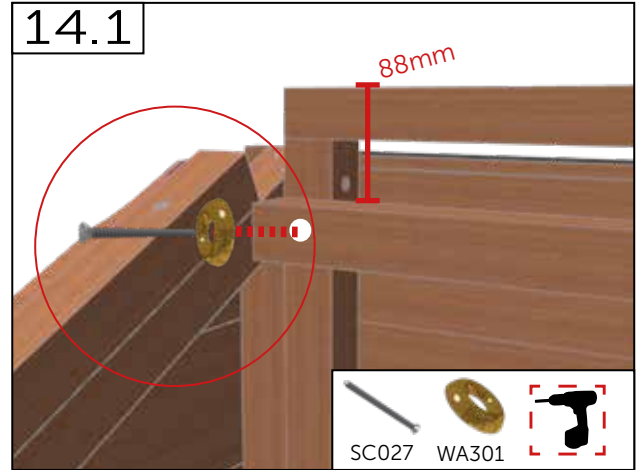
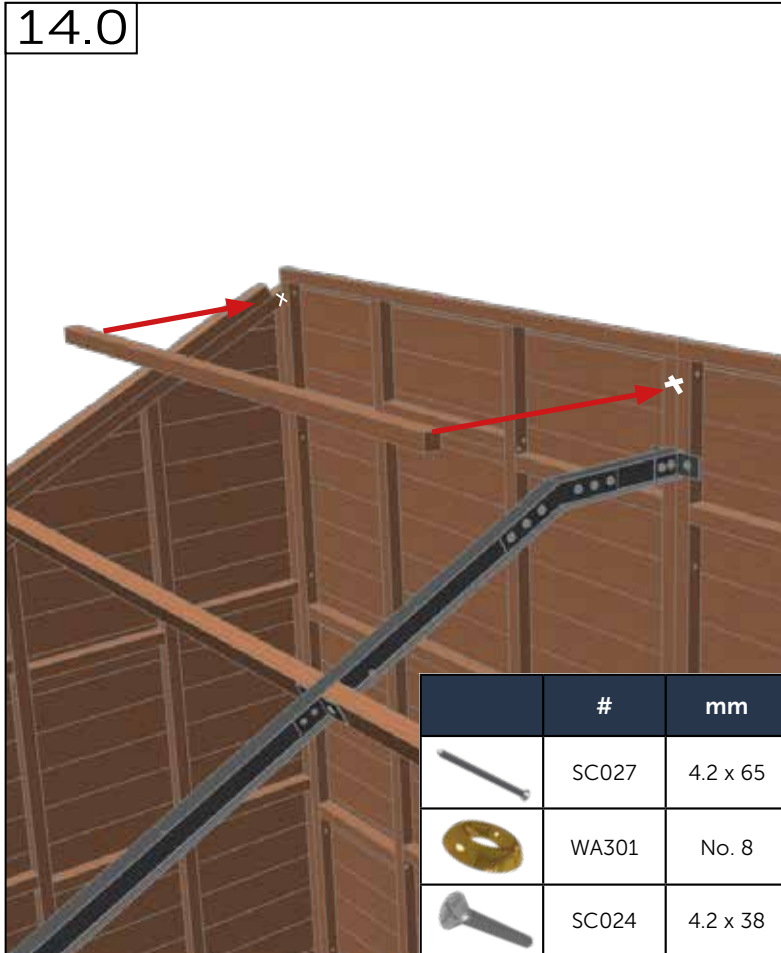

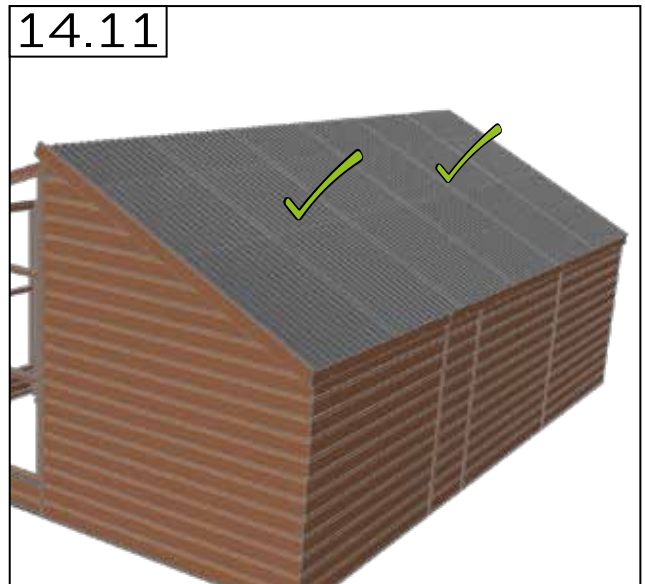
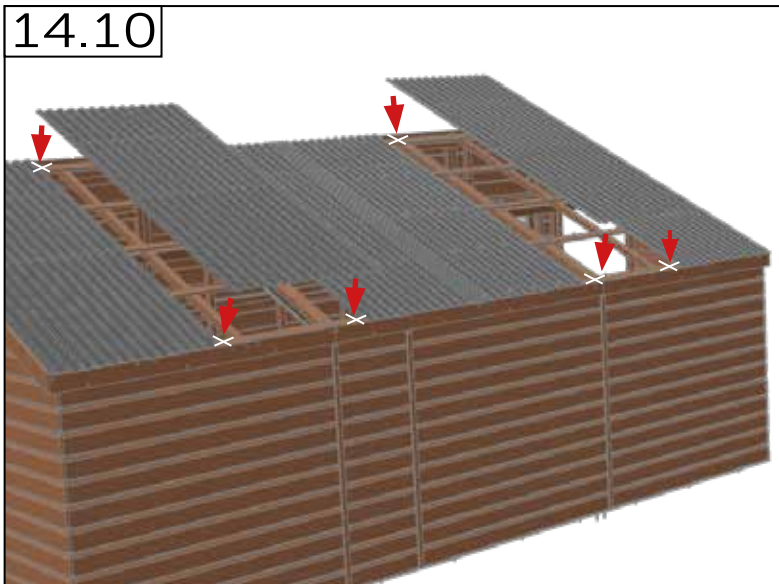
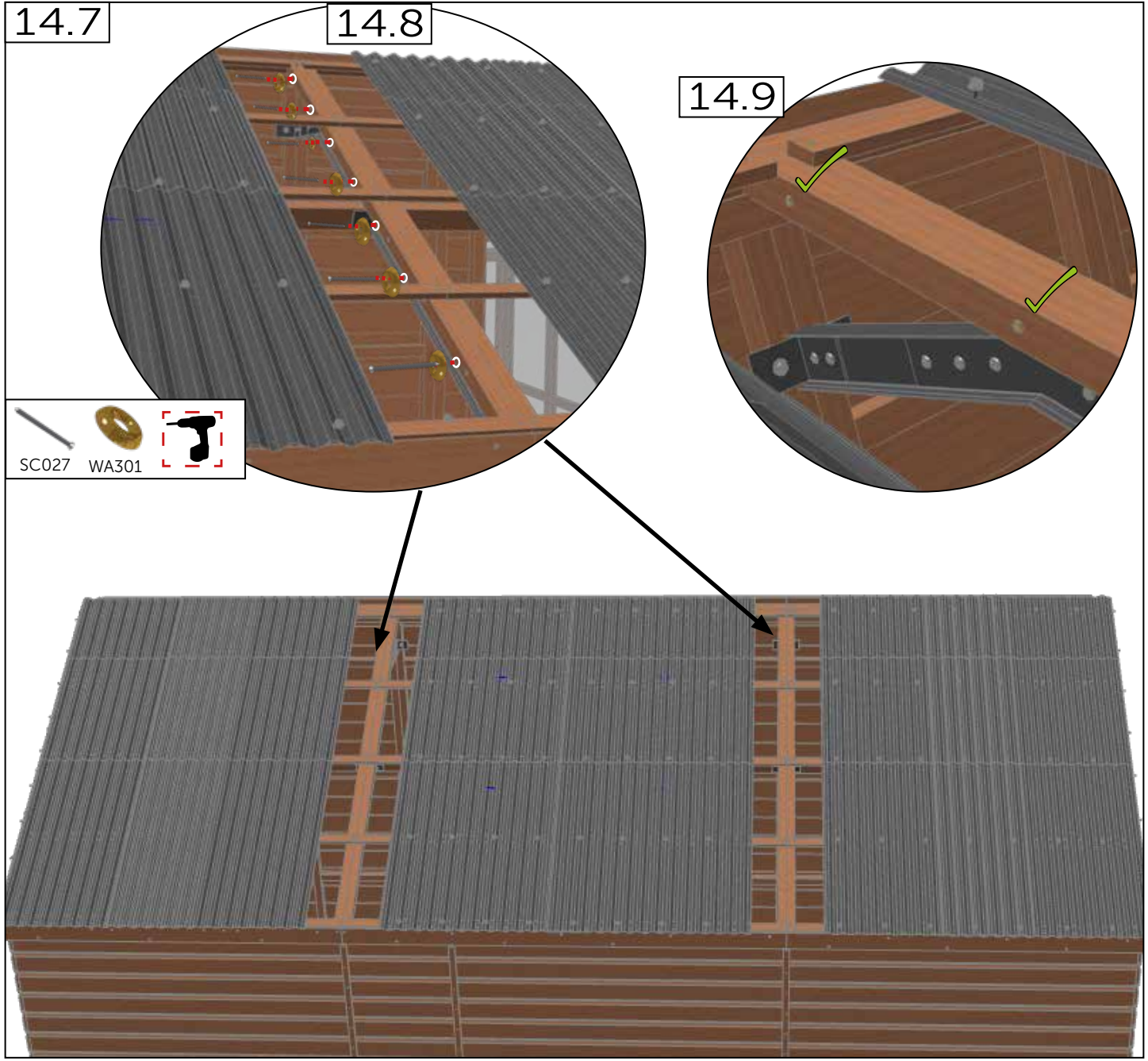

Roof (Extension Length Only) - Toit - Tak - Dach - Tak - Techo - Tag

14.12

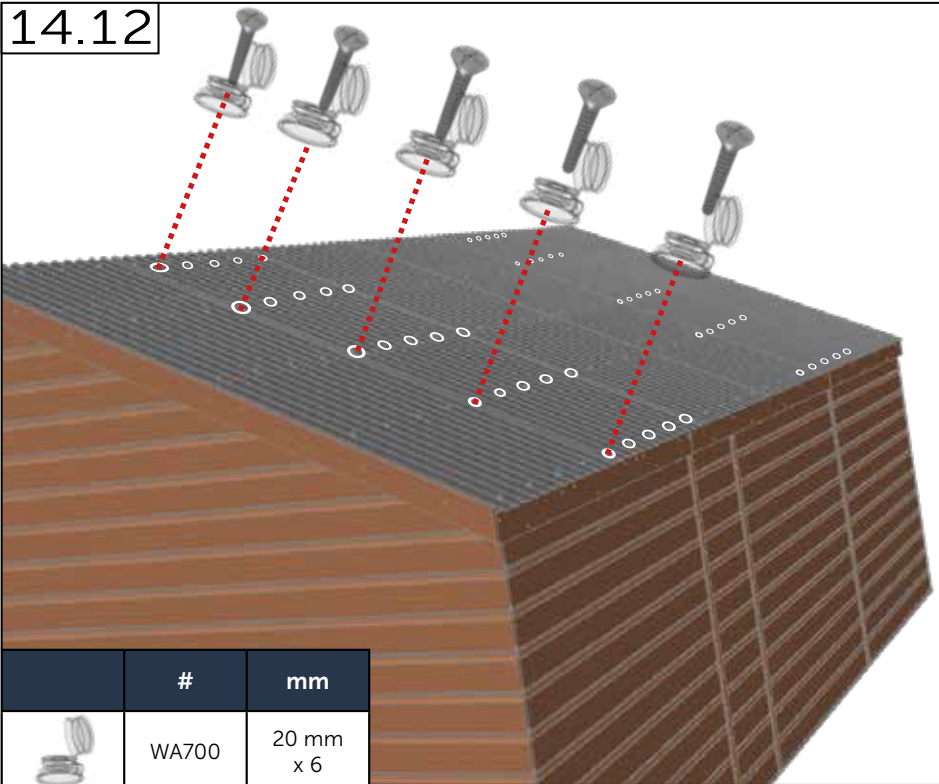

	#	mm
	WA700	20 mm x 6
	SC024	4.2 x 38
	SC057	4.2 x 80

14.13

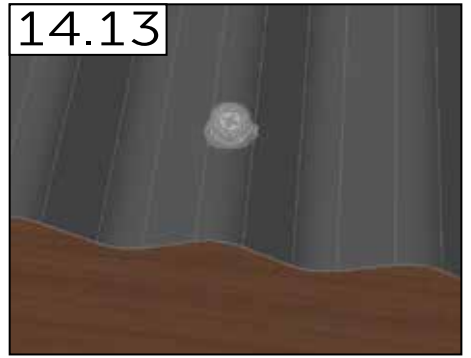

14.14

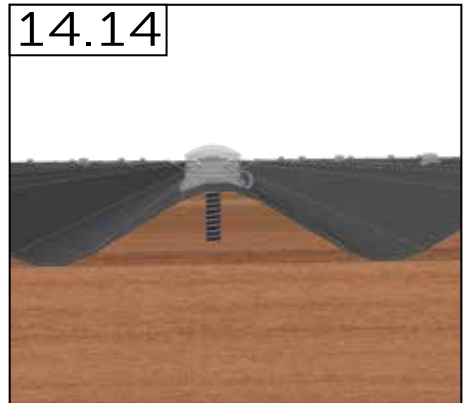

14.15

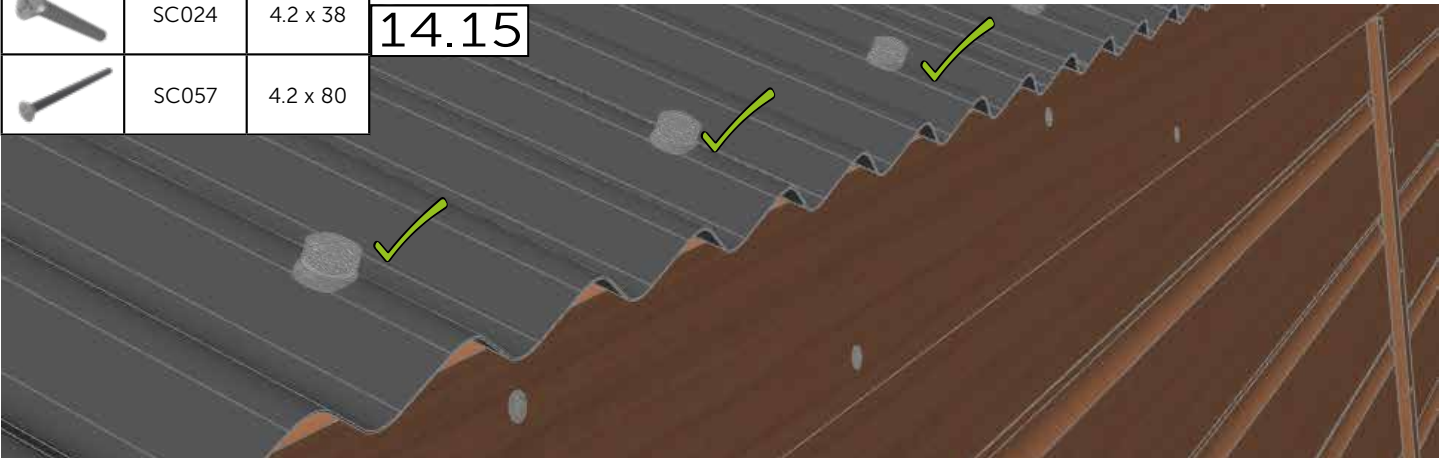

14.16

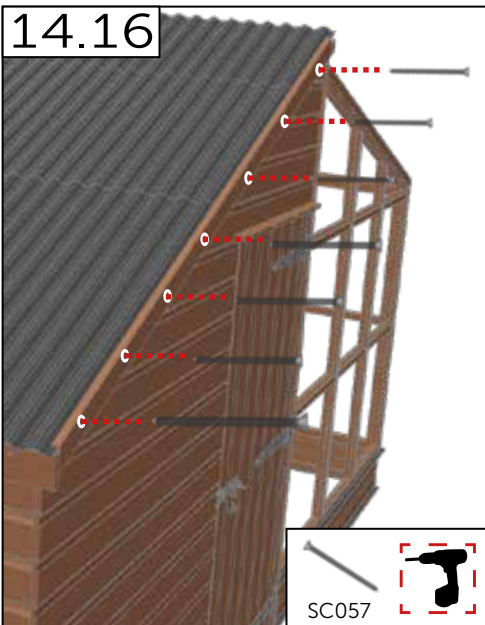

14.17

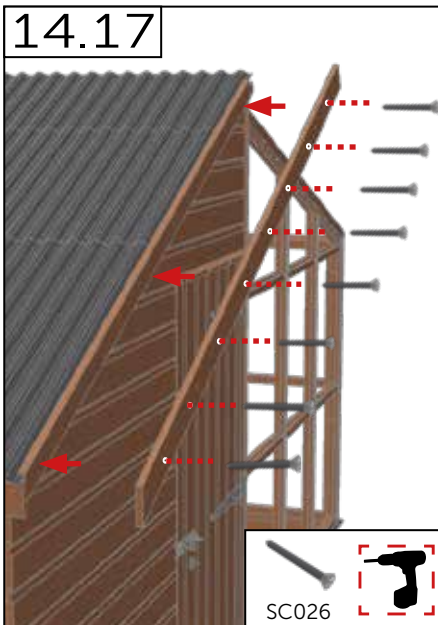

14.18



Roof - Toit - Tak - Dach - Tak - Techo - Tag (Classic 'Grow & Store' only)

15.0 (Classic 'Grow & Store' only)

	#	mm
	A	-
	B AL2520	-
	C AL3460	-
	SC027	4.2 x 65
	WA301	No. 8
	SC125	4.2 x 25
	SC024	4.2 x 38

15.1 (Classic 'Grow & Store' only)

SC027 WA301

15.2 (Classic 'Grow & Store' only)

A

15.3

B

15.4

B

SC024

15.5

B

15.6

B

15.7

SC027

15.8

B

15.9

SC125

Roof - Toit - Tak - Dach - Tak - Techo - Tag
(Classic 'Grand Grow & Store' only)

15.0

(Classic 'Grand Grow & Store' only)

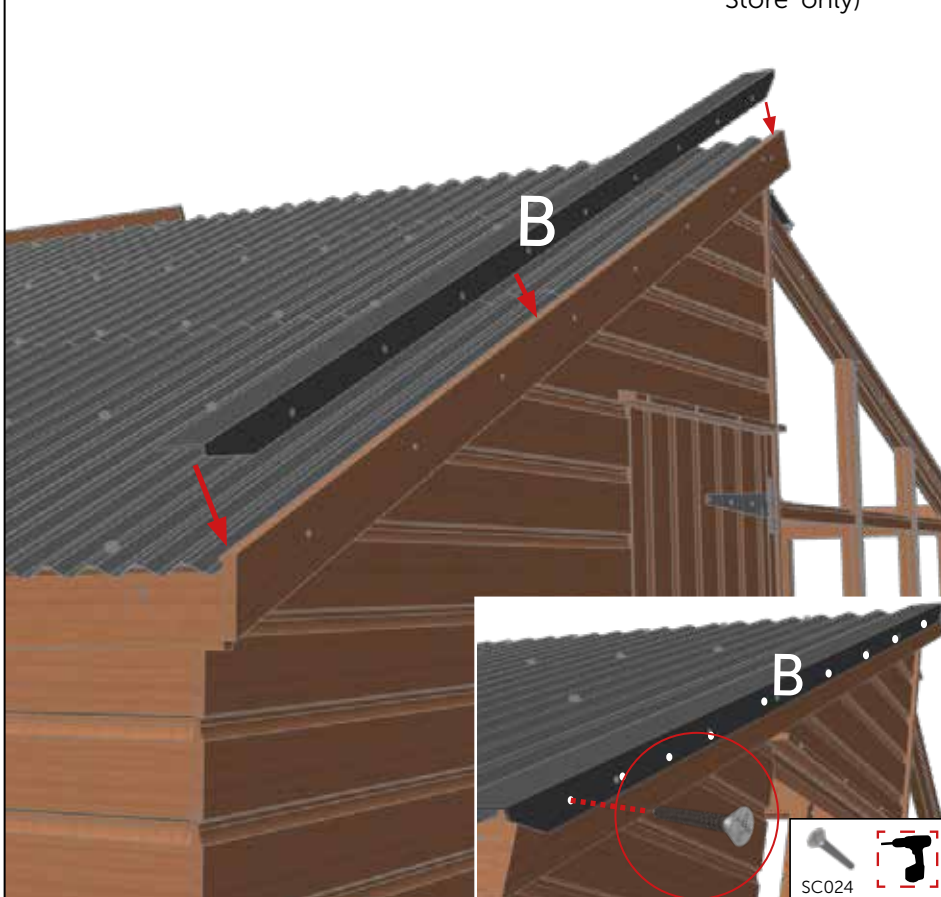

15.1



15.2



15.3

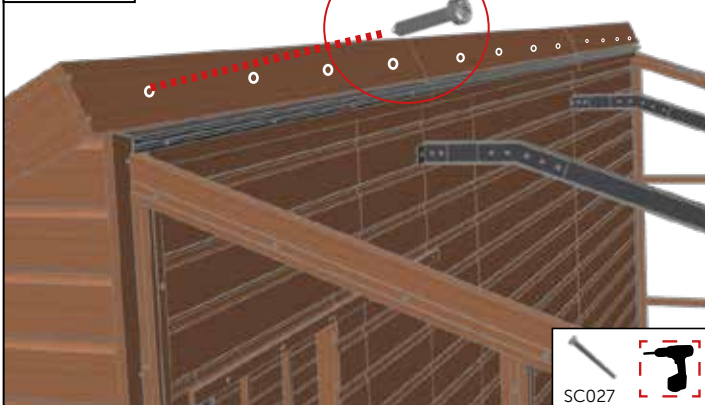

15.4

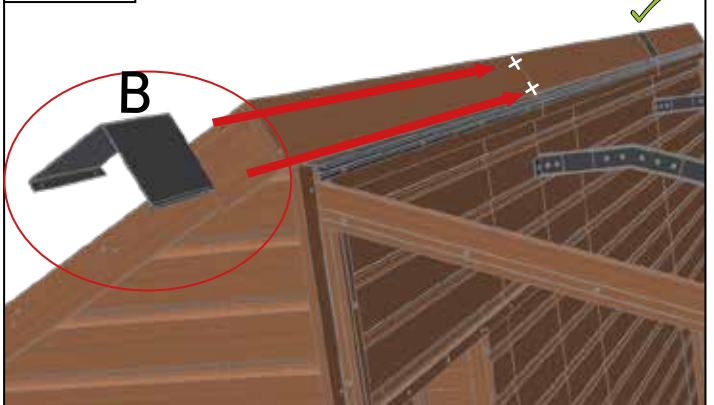

15.5

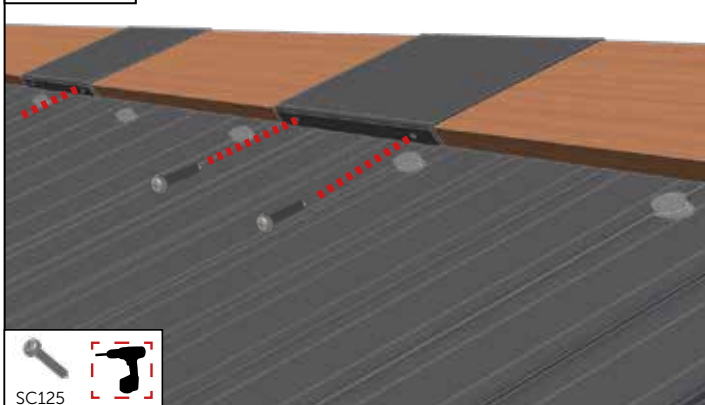

15.6

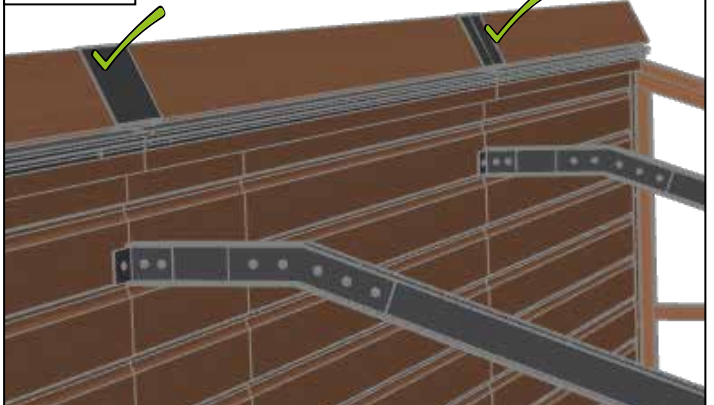

Roof Panels - Panneaux de toit - Takpaneler - Dachplatten - Takpaneler - Paneles de techo - Tagplader

16.0

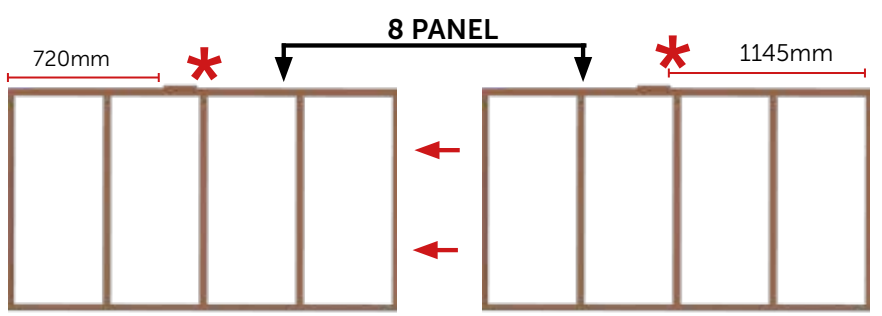
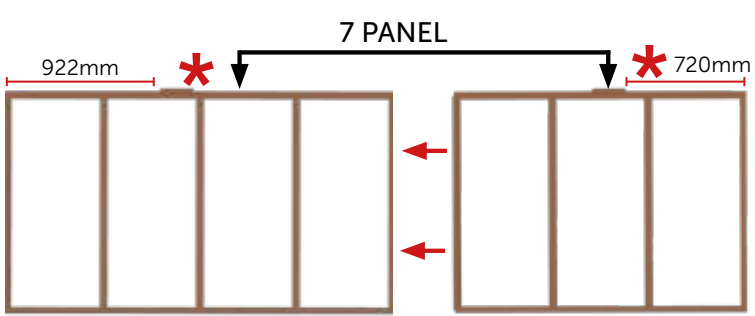
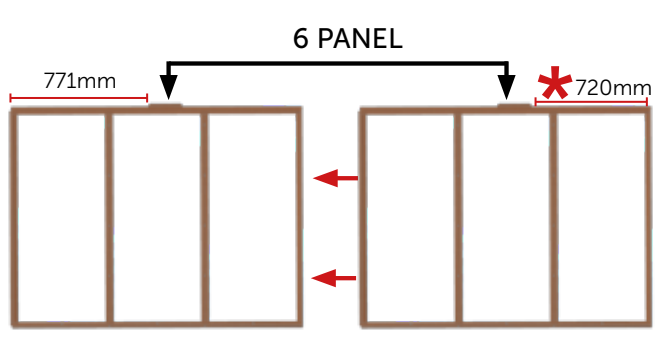
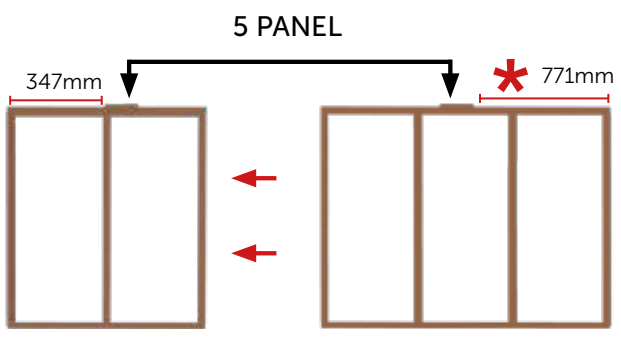
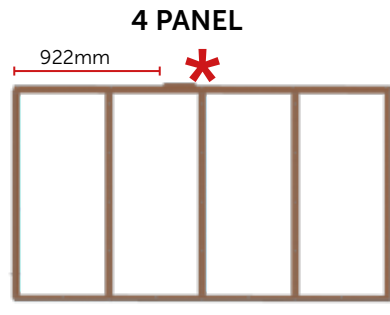
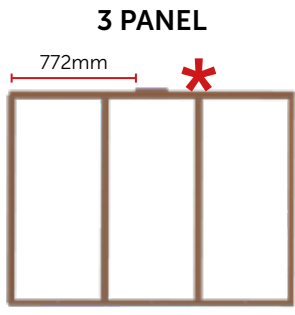

	#	mm
	SC027	4.2 x 65
	WA301	No. 8
	W010	-
	W055	-
	W475-305	-
	SC026	4.2 x 50
	SC057	4.2 x 80

17.8

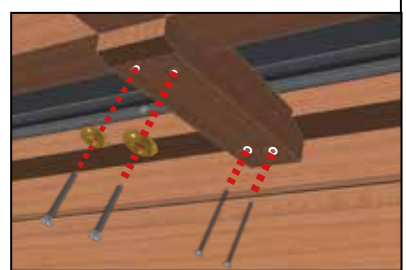
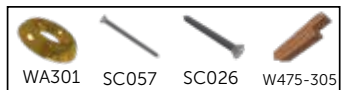
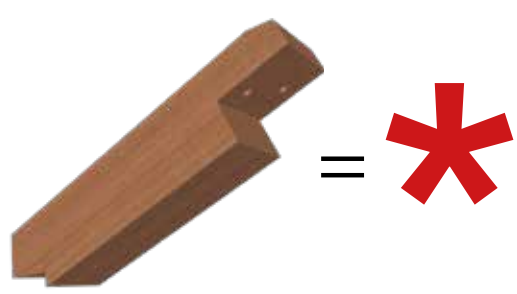

Roof Panels - Panneaux de toit - Takpaneler - Dachplatten
 - Takpaneler - Paneles de techo - Tagplader

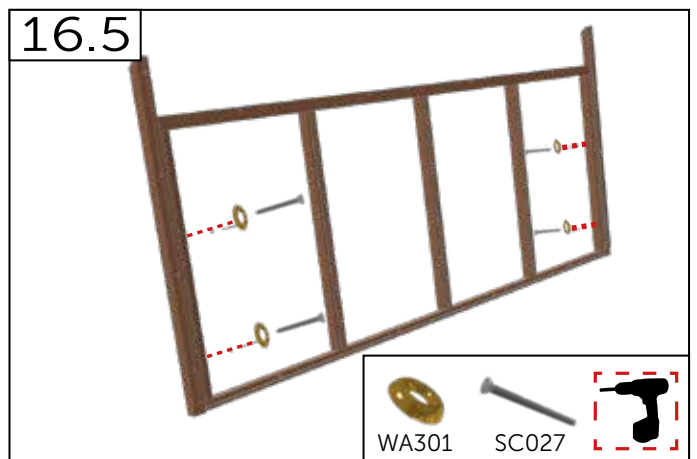
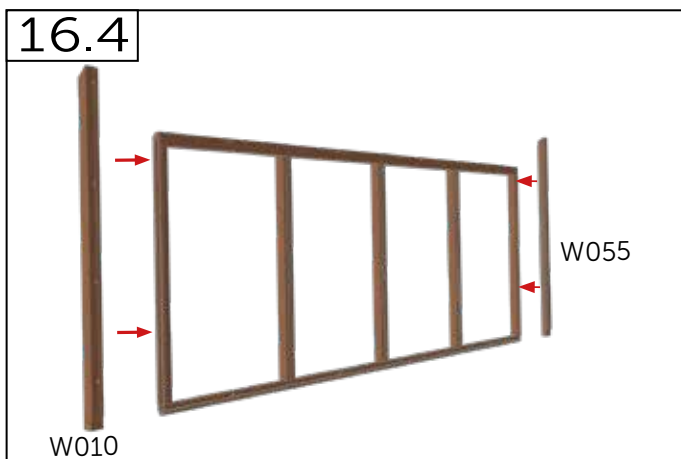
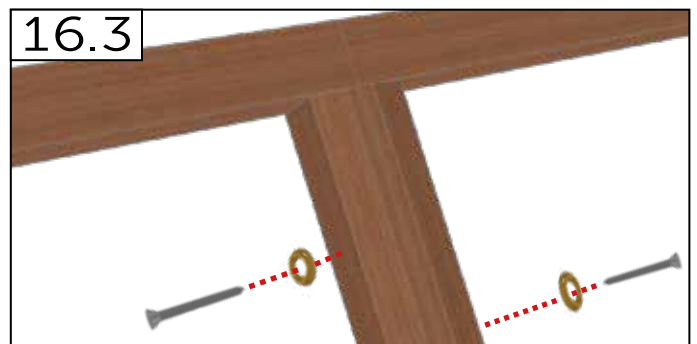
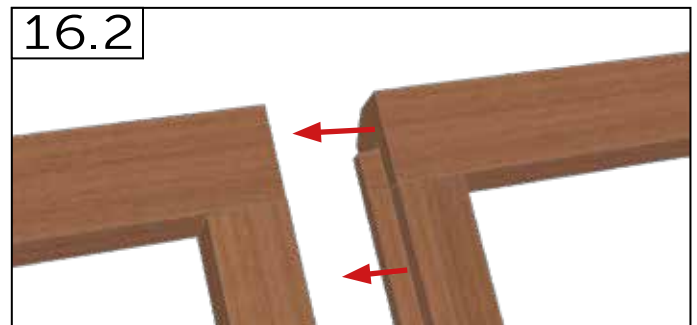
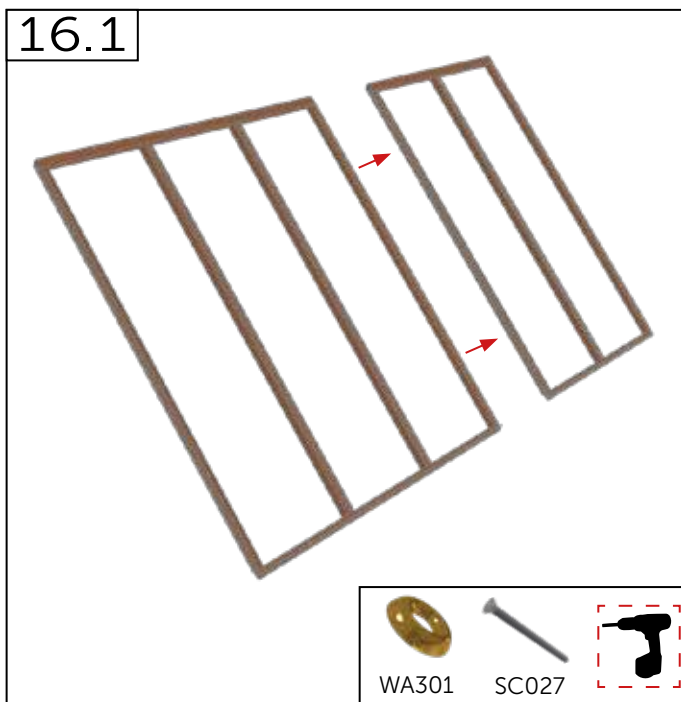
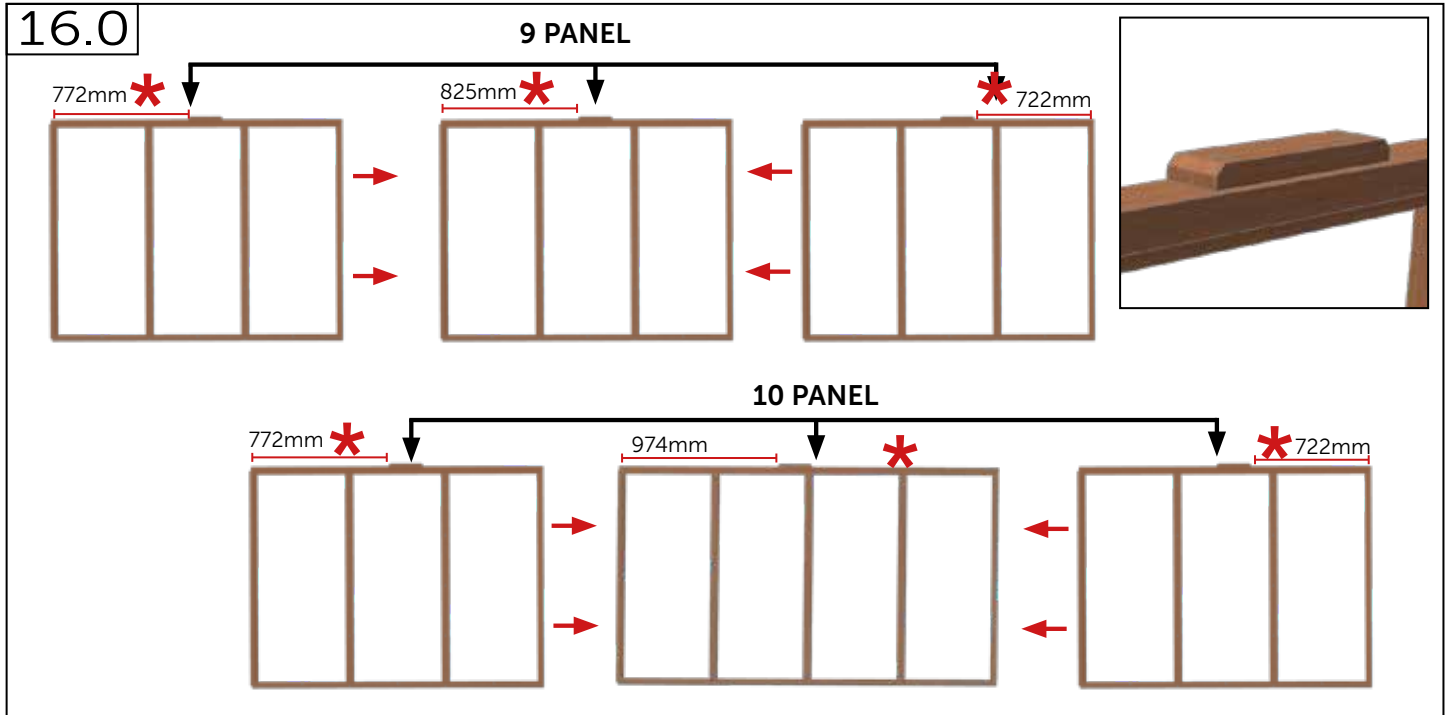

17.0

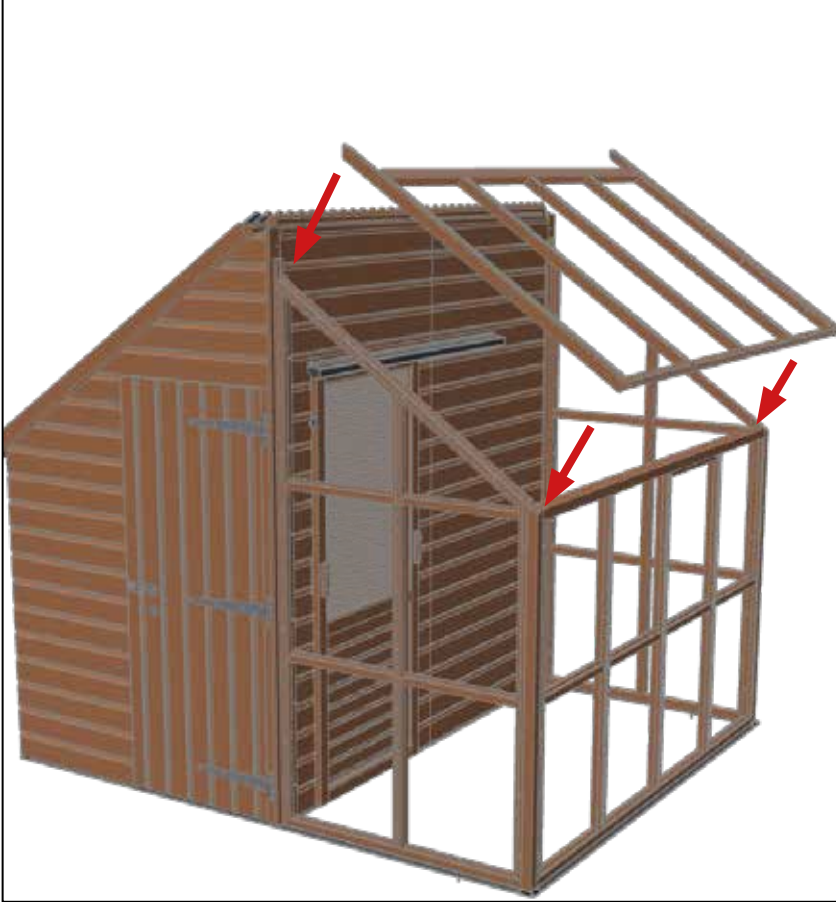

17.1

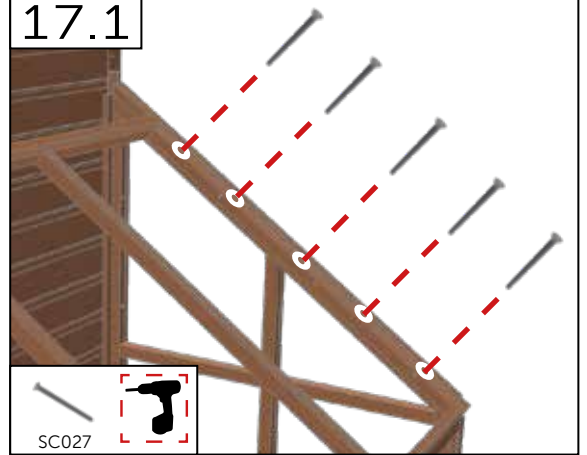

17.2

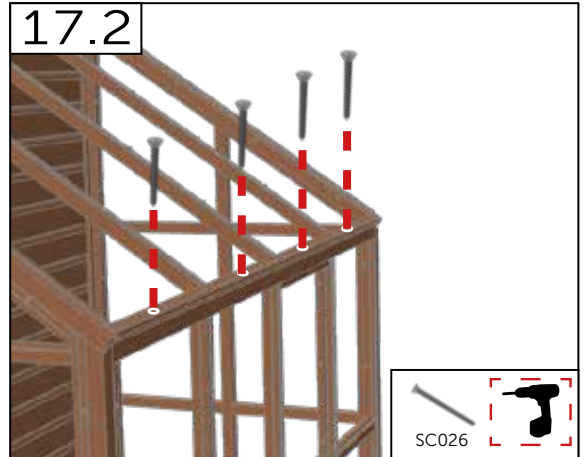

17.3



	#	mm
	SC027	4.2 x 65
	WA301	No. 8
	SC125	4.2 x 25
	SC026	4.2 x 50
	SC057	4.2 x 80

Roof (Extension Length Only) - Toit - Tak - Dach - Tak - Techo - Tag

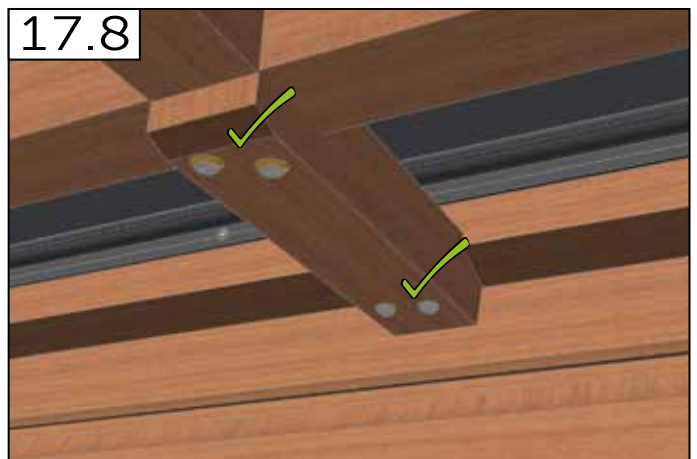
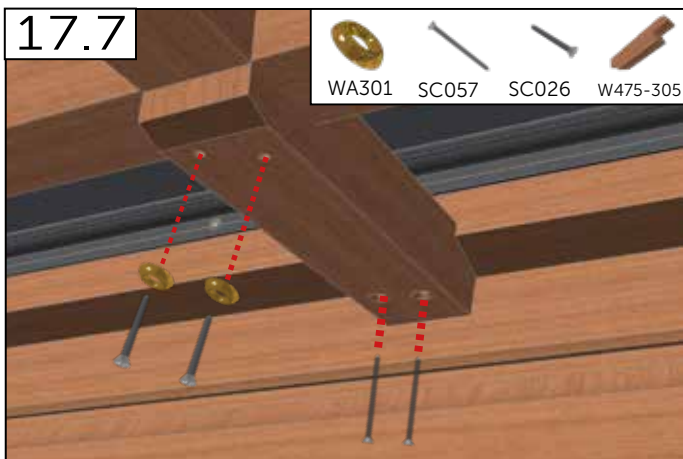
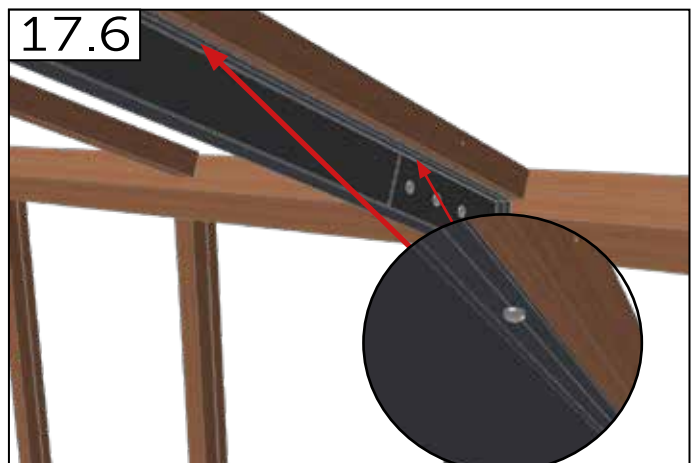
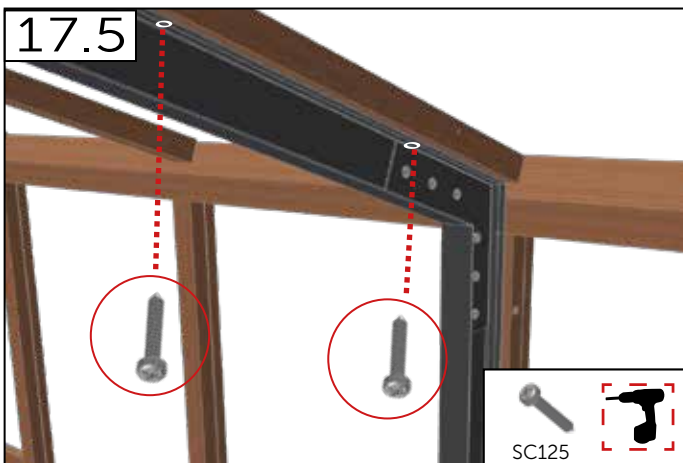
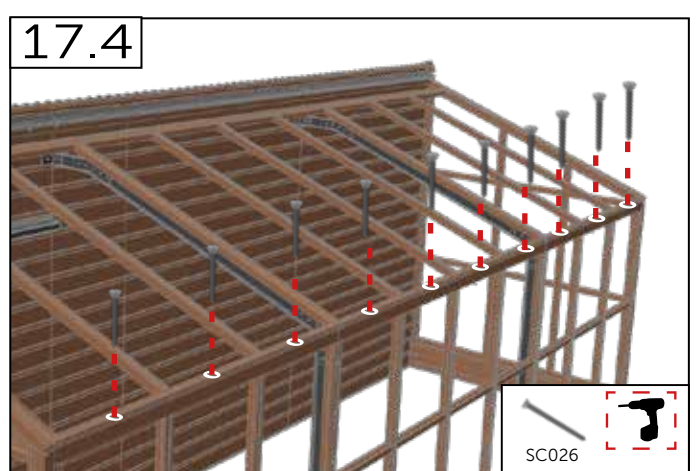
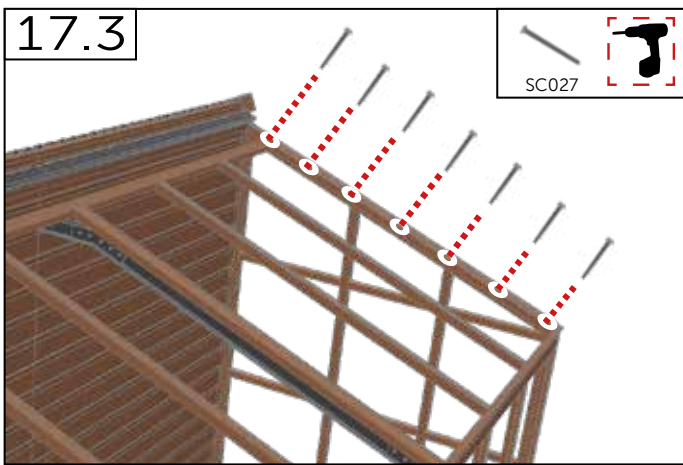
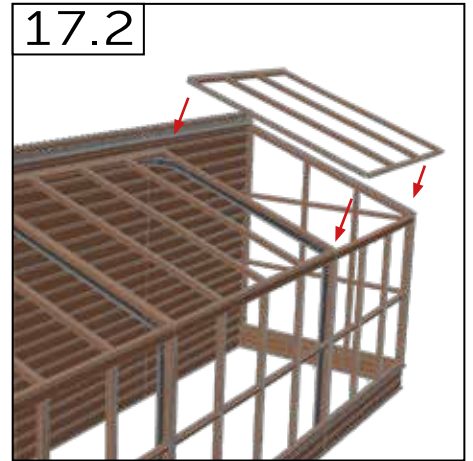
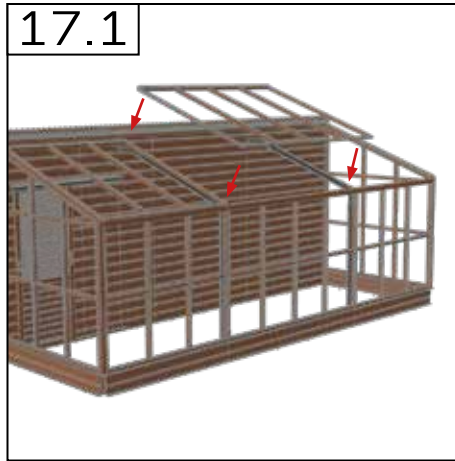
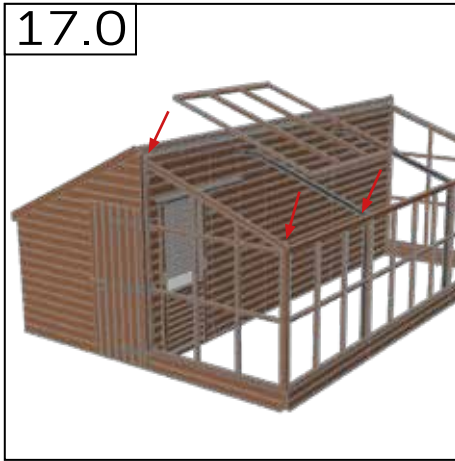

18.0

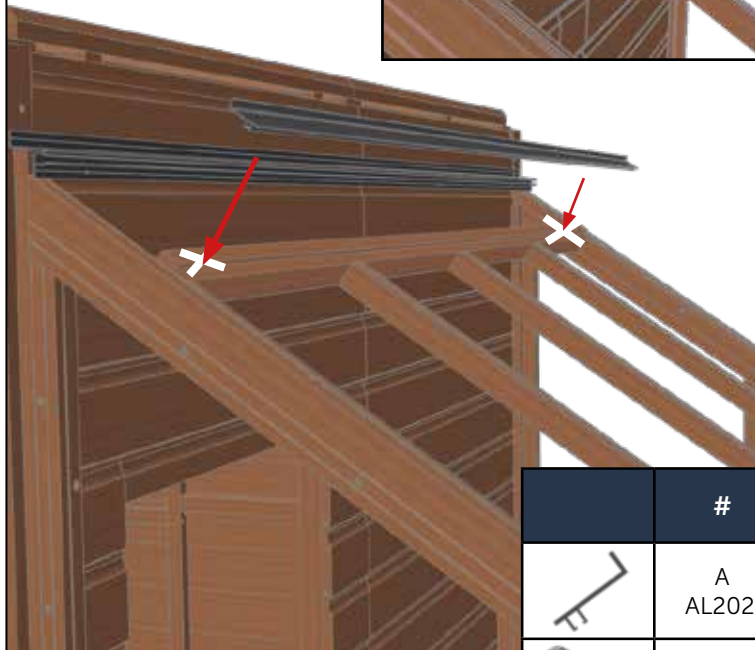

18.1

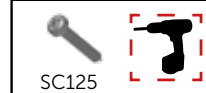
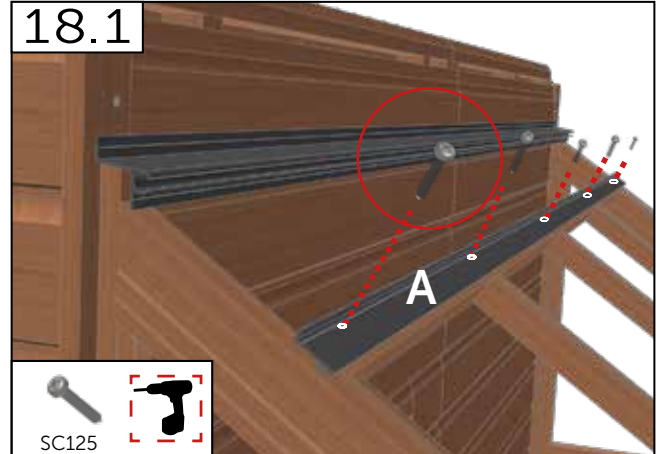

18.2

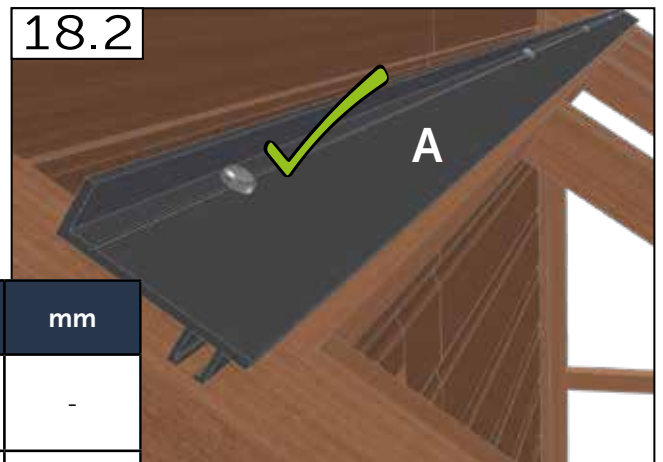

	#	mm
	A AL2021	-
	SC125	4.2 x 25
	AL3010	-

18.3

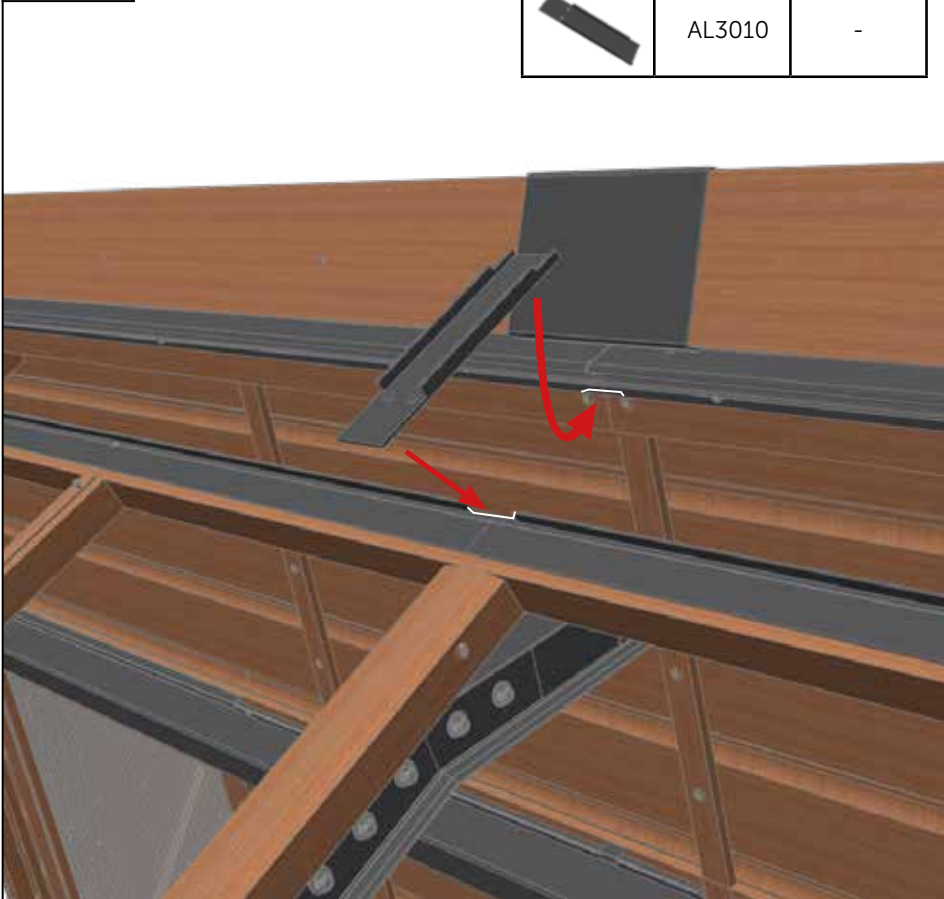

18.3

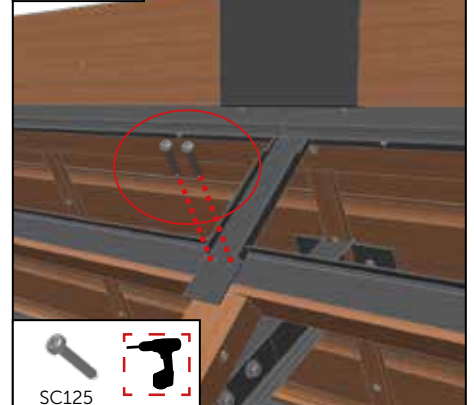

18.3



Trims (Extension Length Only) - Garnitures - Trims - Schnitte - Trimmer - Adornos

	#	mm
	B AL2002	-
	AV001	-
	WA500	M6 x 16
	NU101	M6
	BL122	M6 x 16

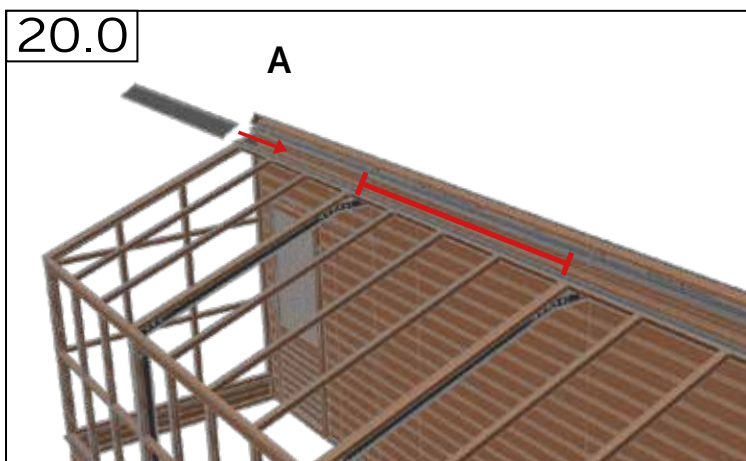
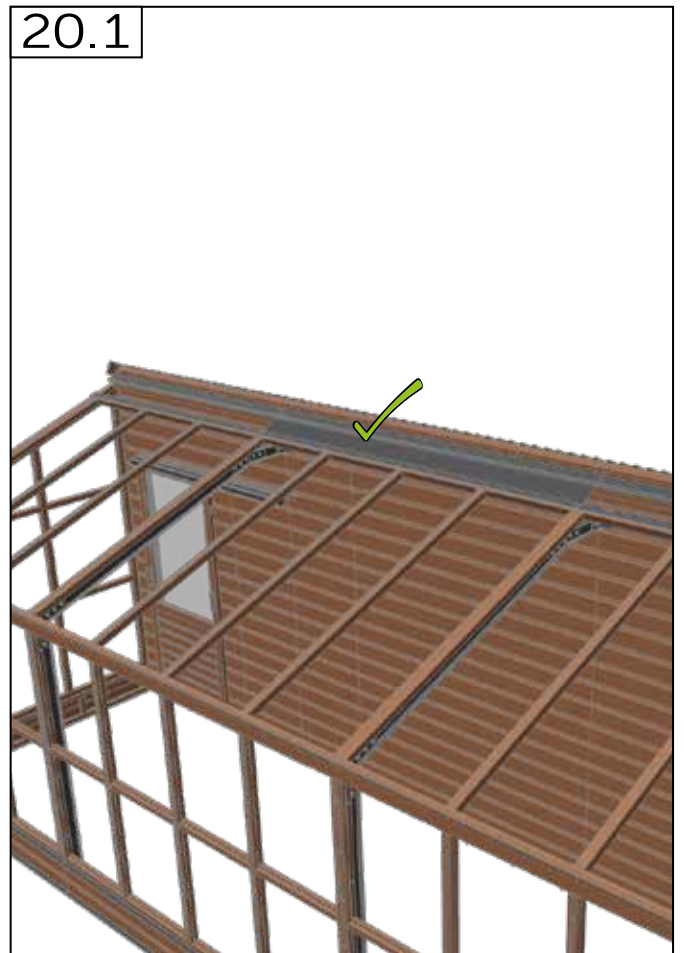
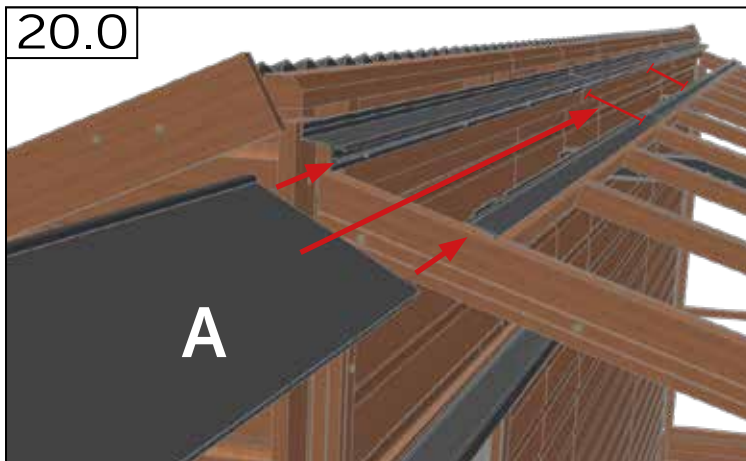
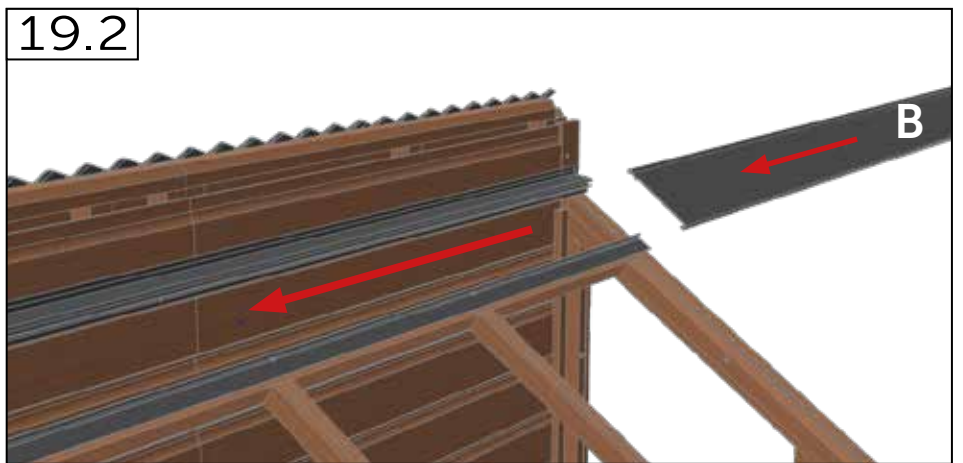
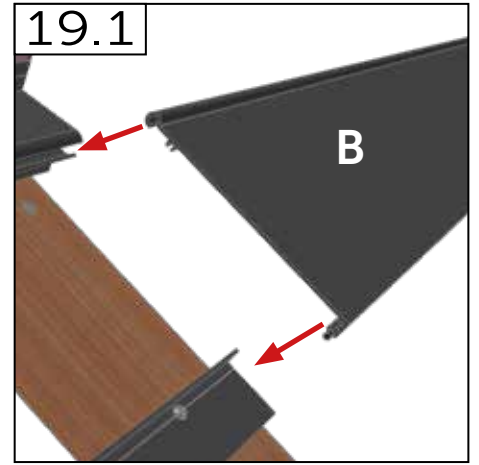
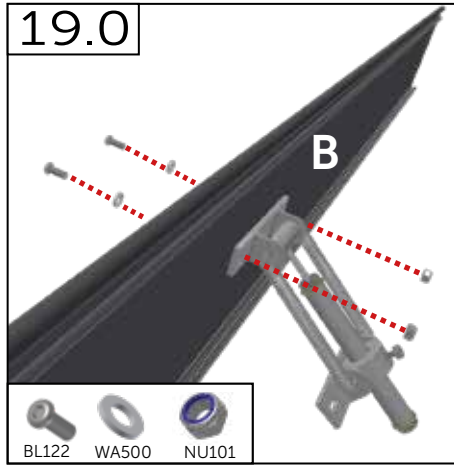

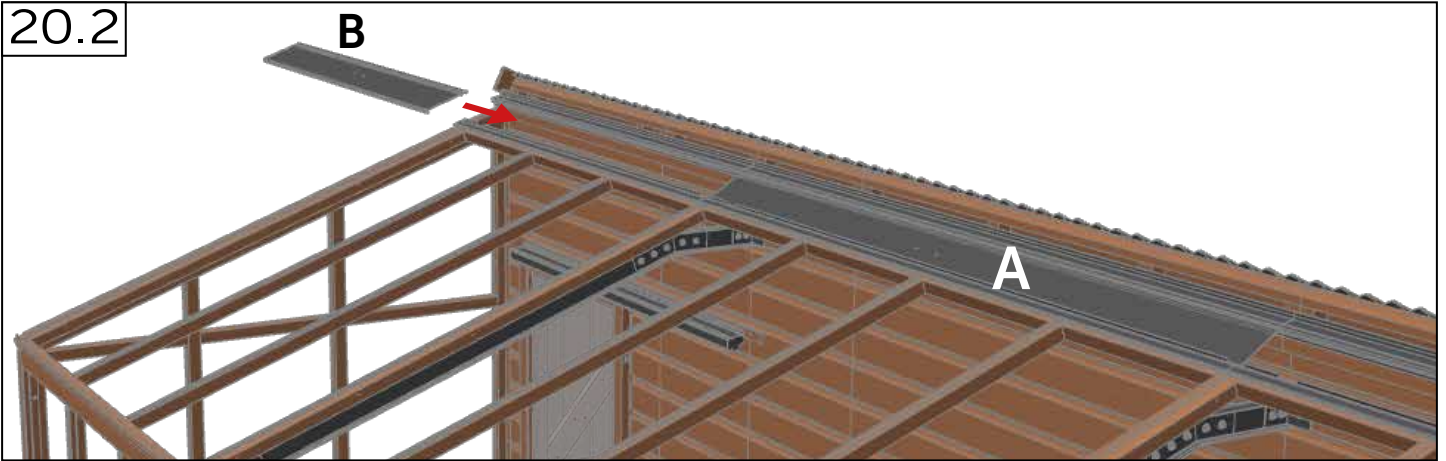

Trims (Extension Length Only) - Garnitures - Trims - Schnitte
 - Trimmer - Adornos

20.2

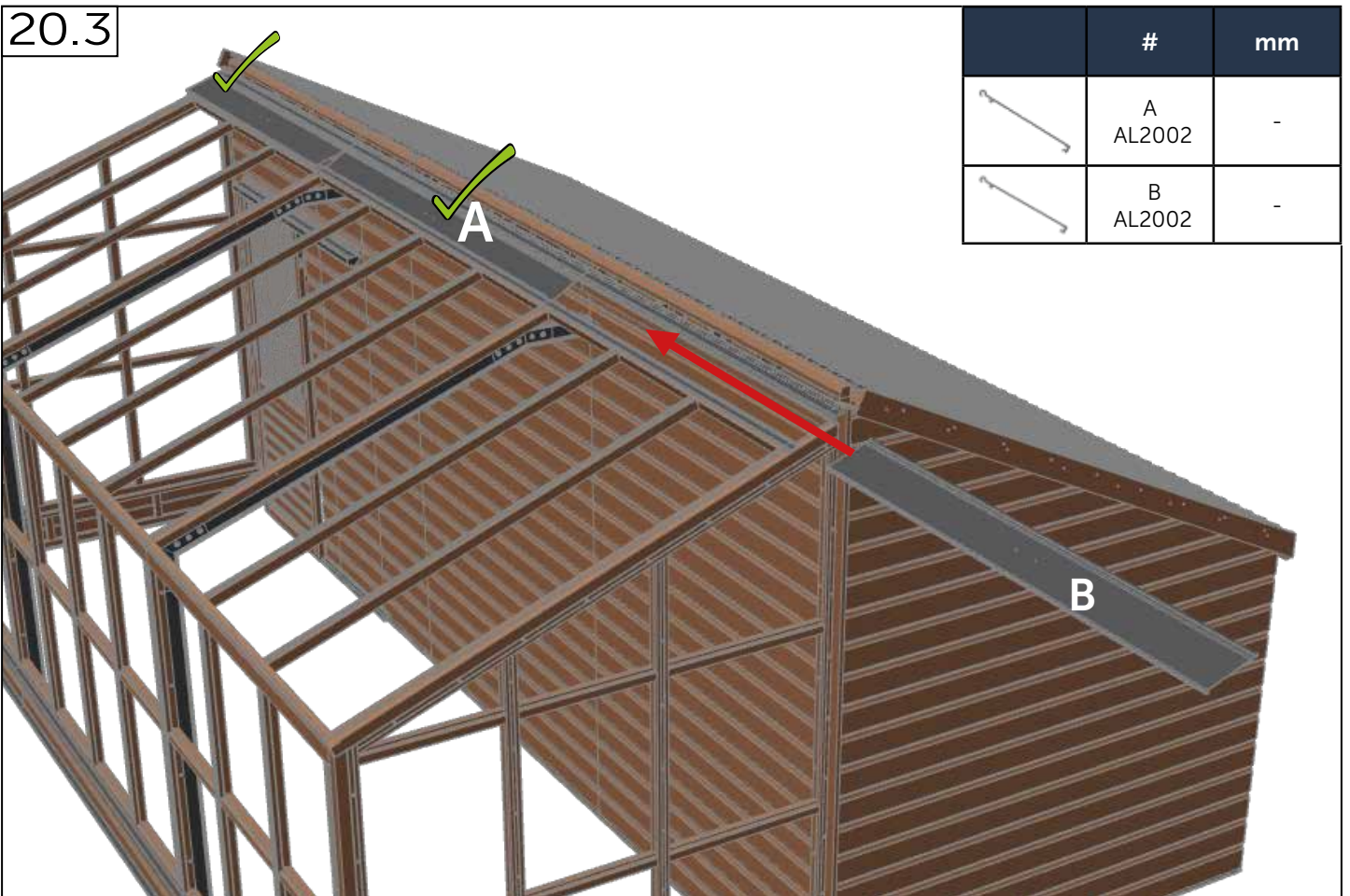

20.3



	#	mm
	A AL2002	-
	B AL2002	-

20.4

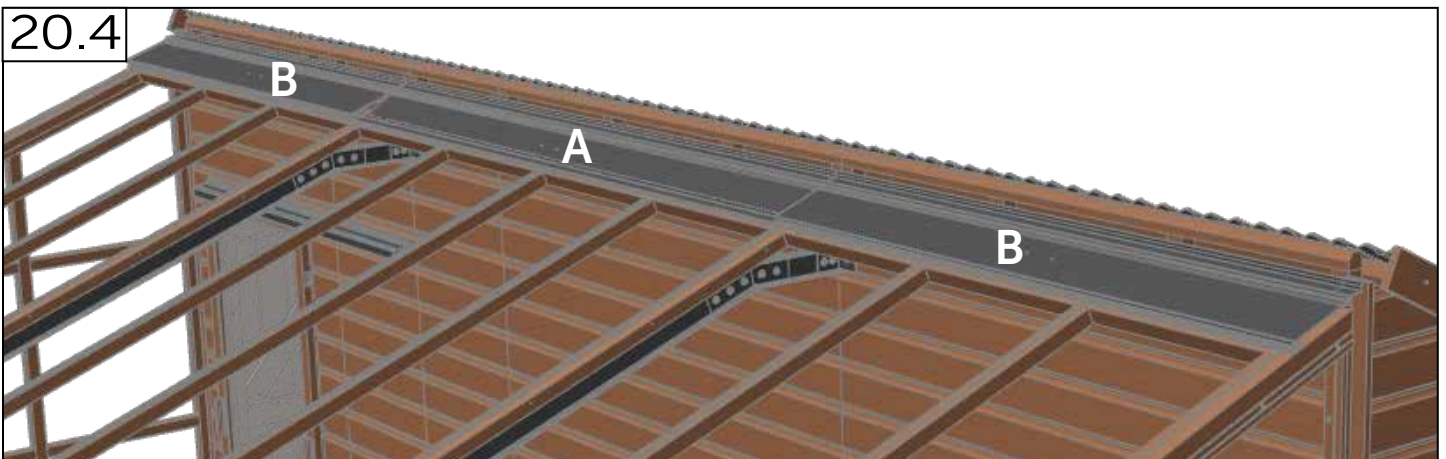

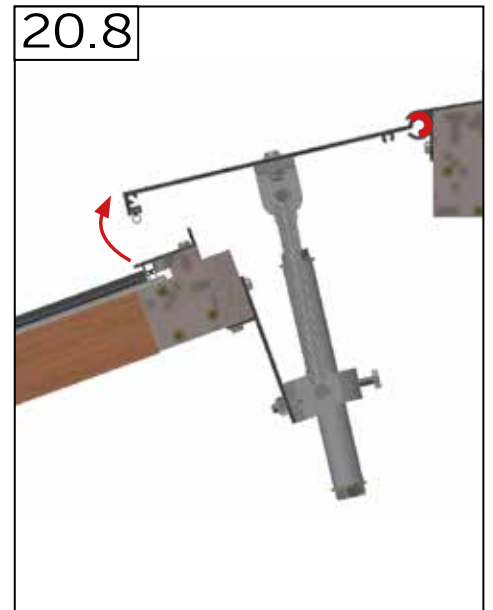
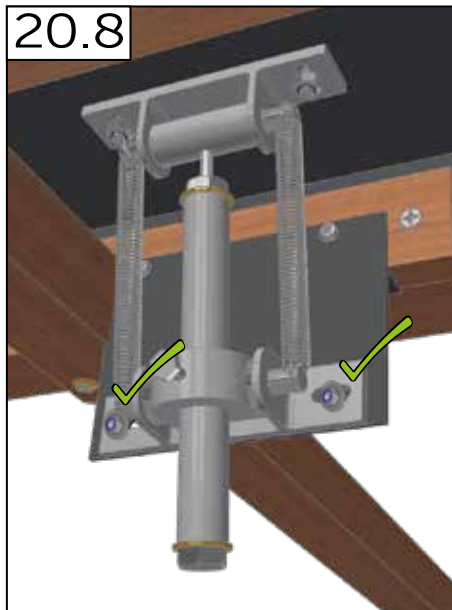
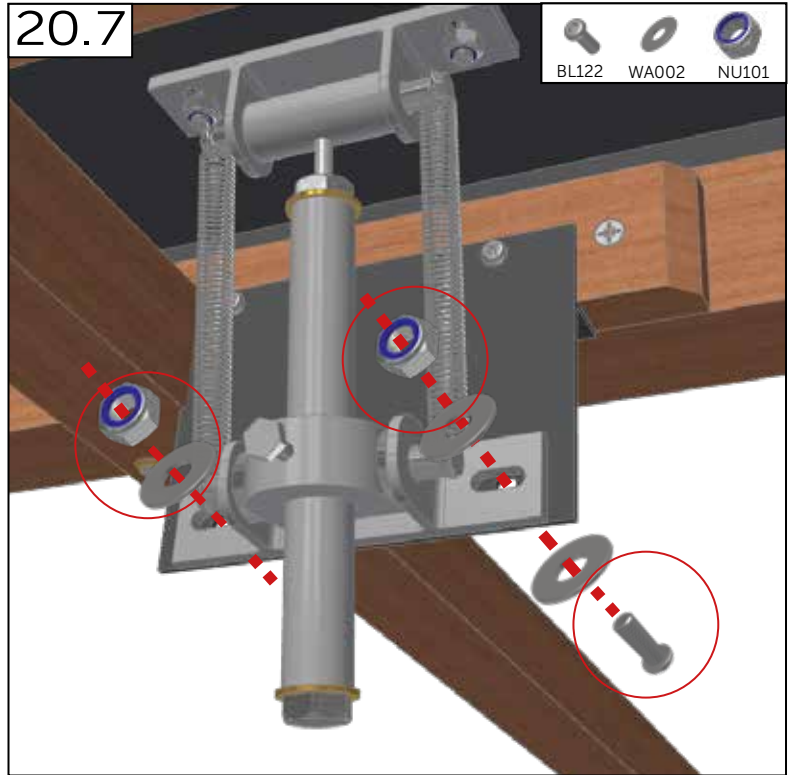
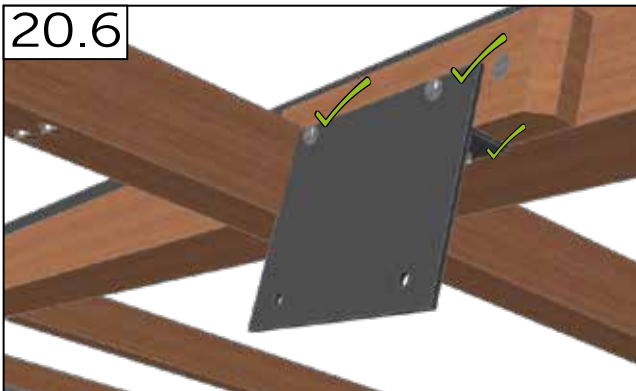
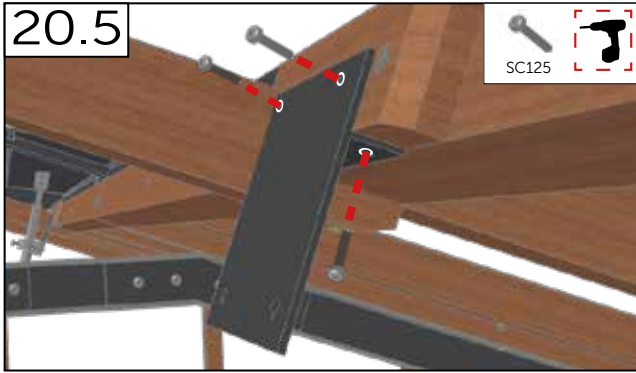



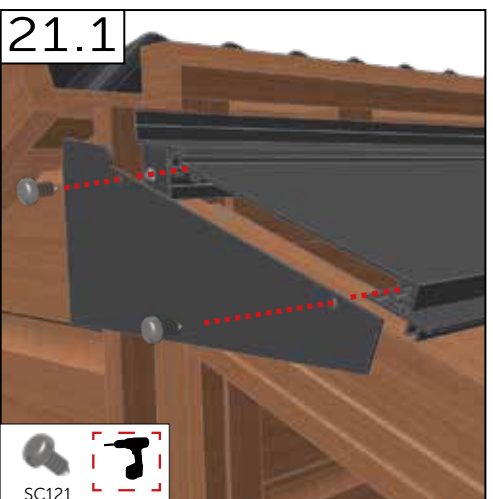
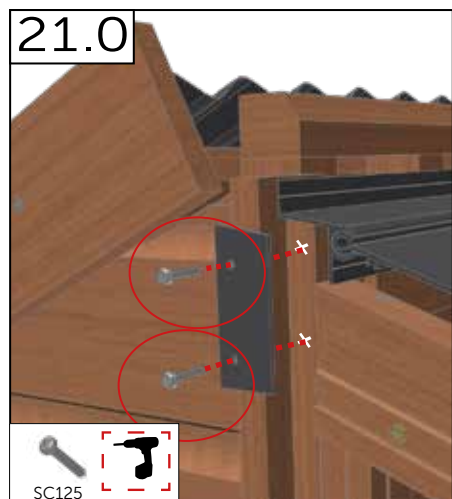

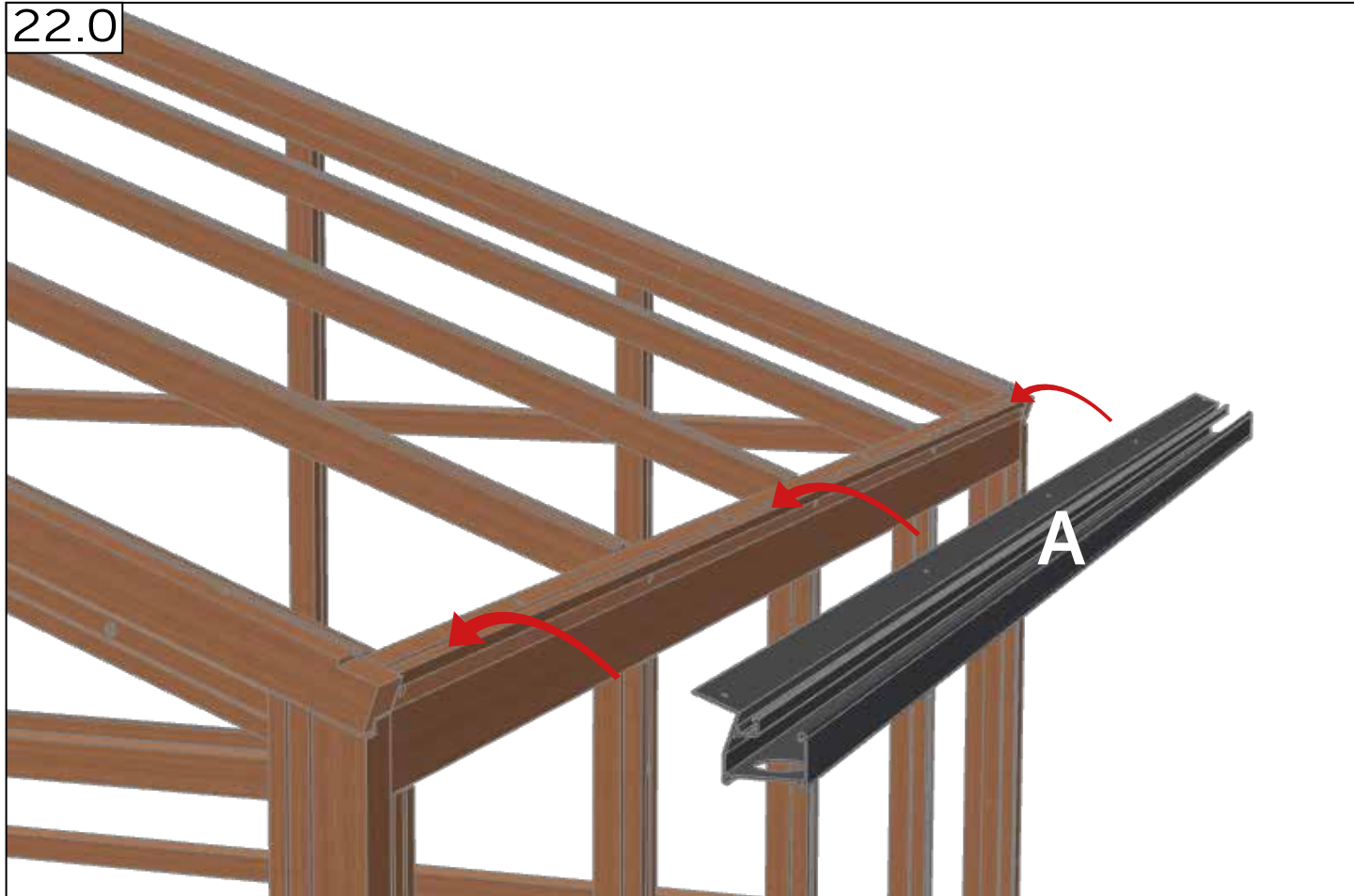

	#	mm
	AV001	-
	SC121	4.2 x 9.5
	A AL3025	-
	W430-05	-
	AL2031 /0130	-
	SC024	4.2 x 38
	SC125	4.2 x 25
	BL122	M6 x 16
	NU101	M6
	WA002	M6



22.0



	#	mm
	A AL2008	-
	PT200	MALE FEMALE
	SC125	4.2 x 25
	SC121	4.2 x 9.5
	B AL3003	-

22.1

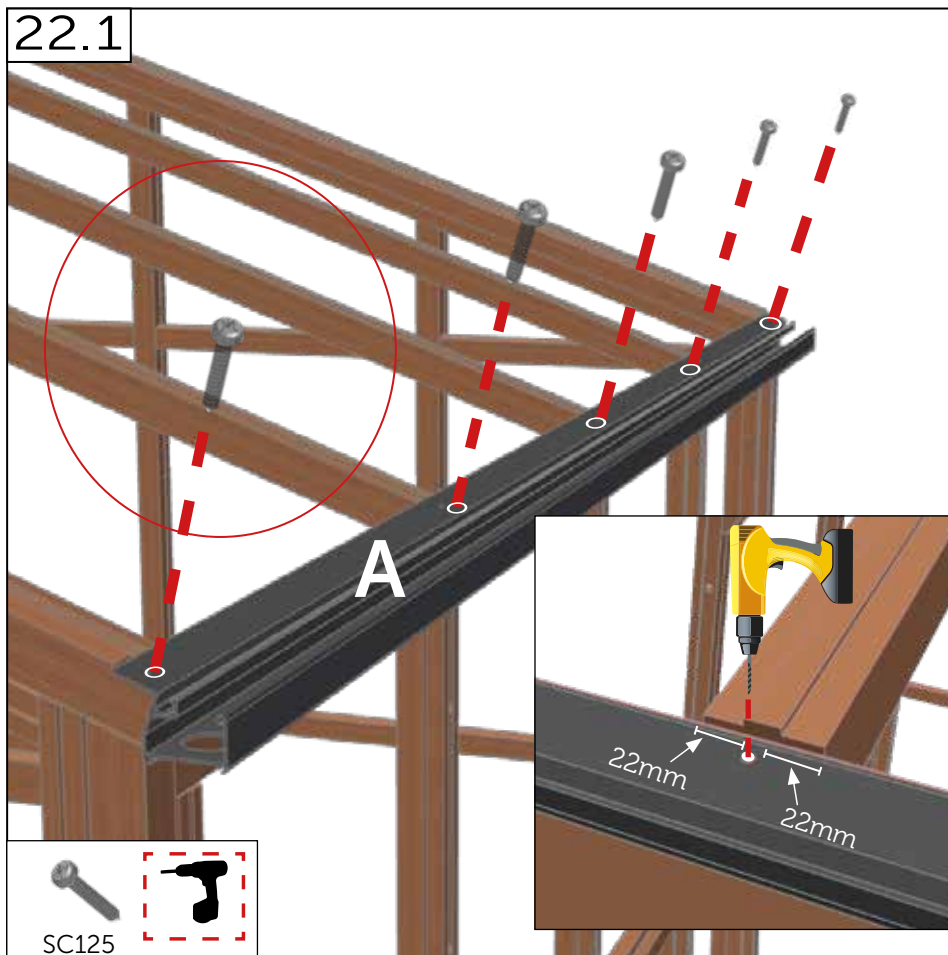

SC125

22.2



22.3

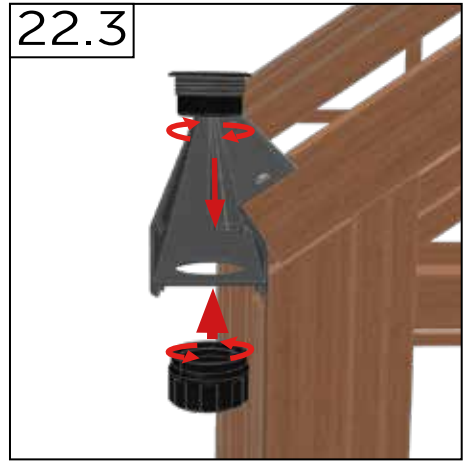

22.4

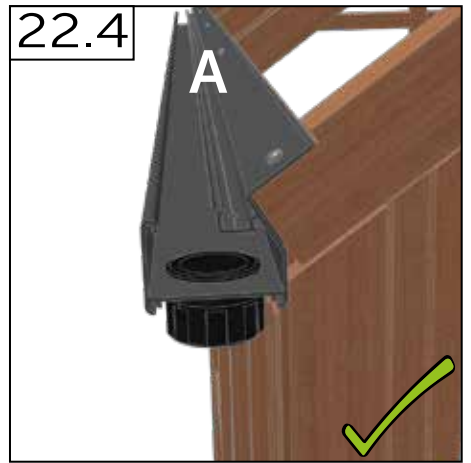

22.5

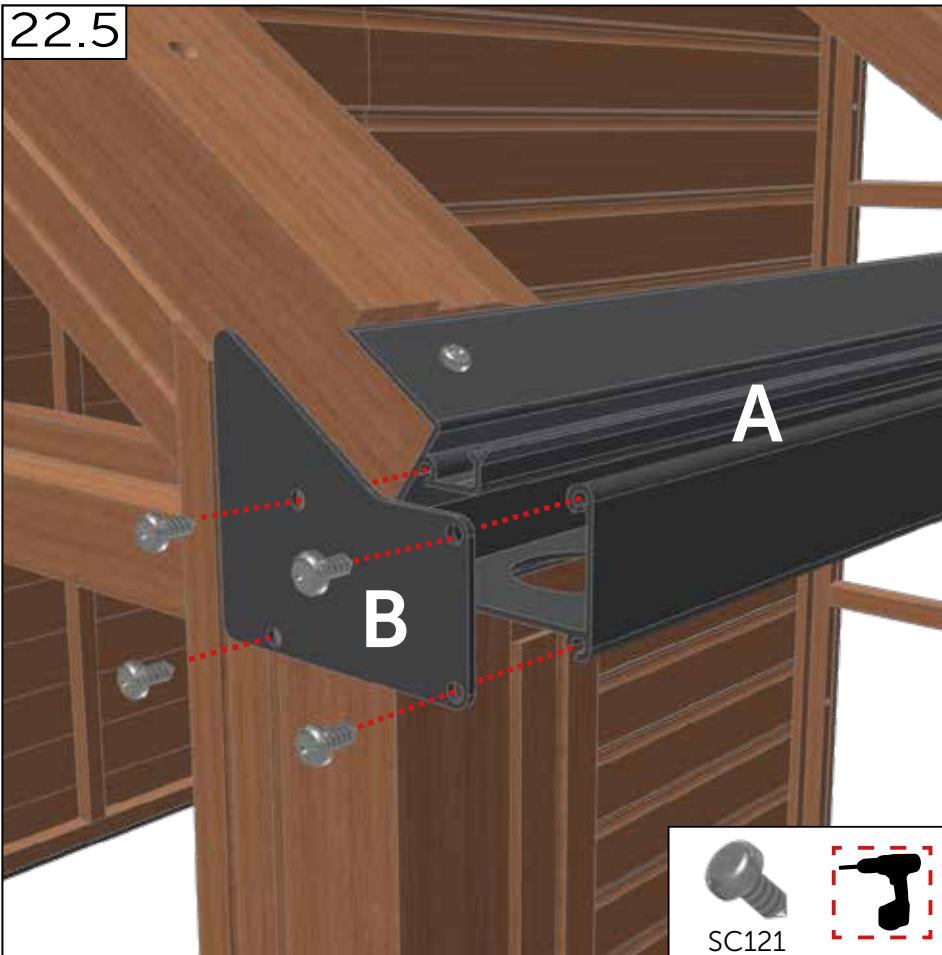

22.6

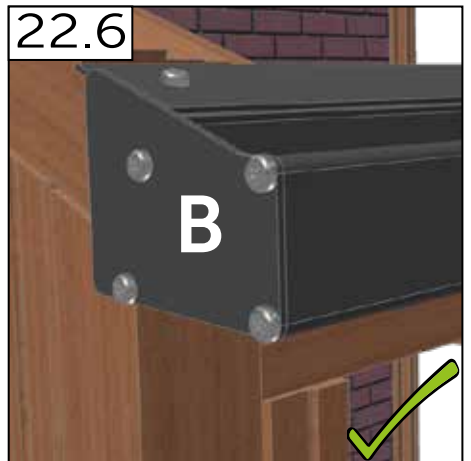

22.7



Trims (Extension Length Only) - Garnitures - Trims - Schnitte
 - Trimmer - Adornos

23.0



23.1

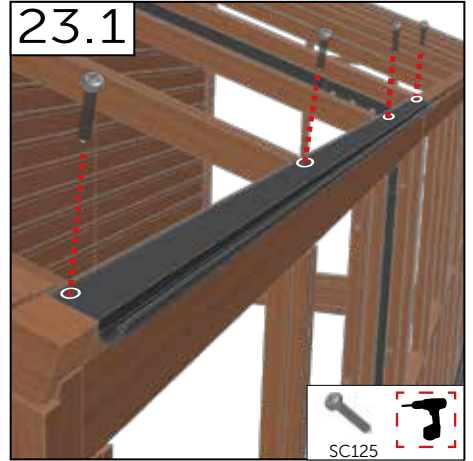

23.2

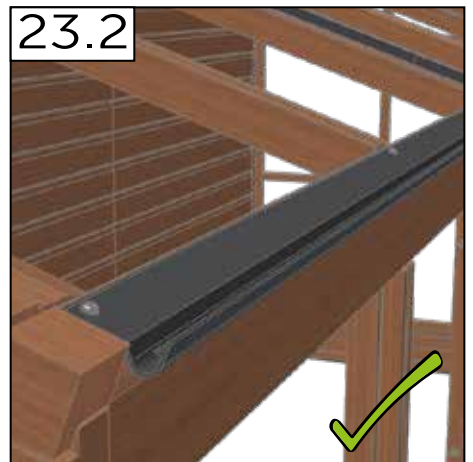

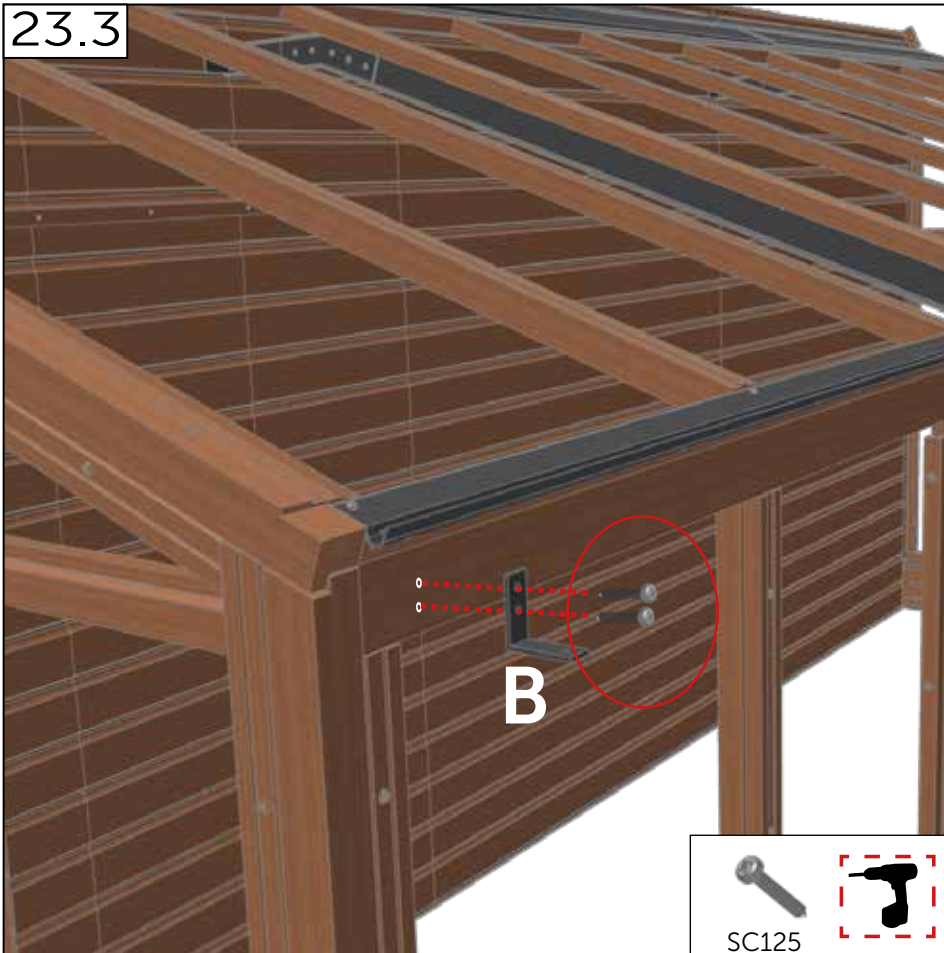

23.3



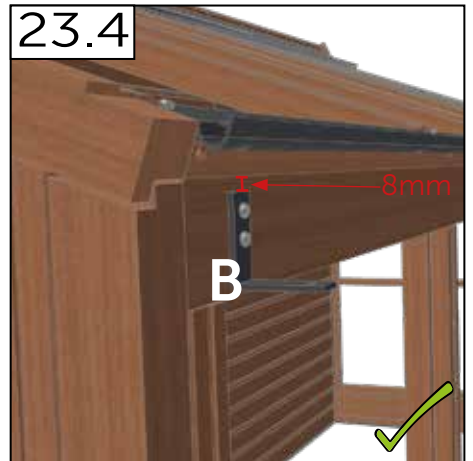







23.4



	#	mm
	A AL2022	-
	SC125	4.2 x 25
	B AL3051	-

Trims (Extension Length Only) - Garnitures - Trims - Schnitte - Trimmer - Adornos

	#	mm
	LH AL2014	-
	RH AL2014	-
	C AL3018	-
	PT200	MALE FEMALE
	BL122	M6 x 16
	WA500	M6
	NU101	M6
	PT204	-

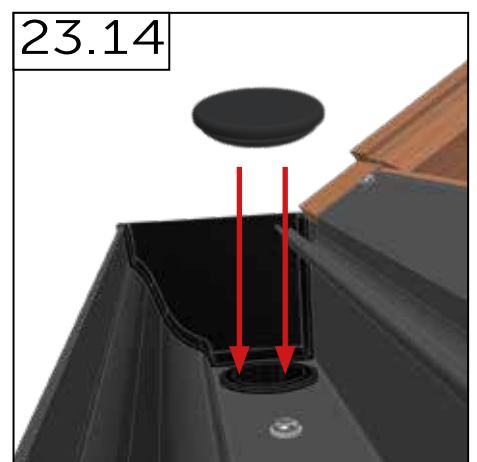
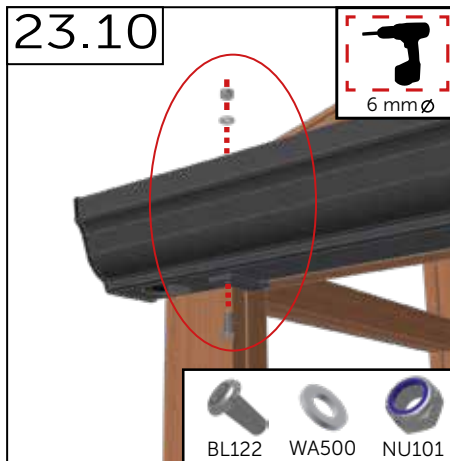
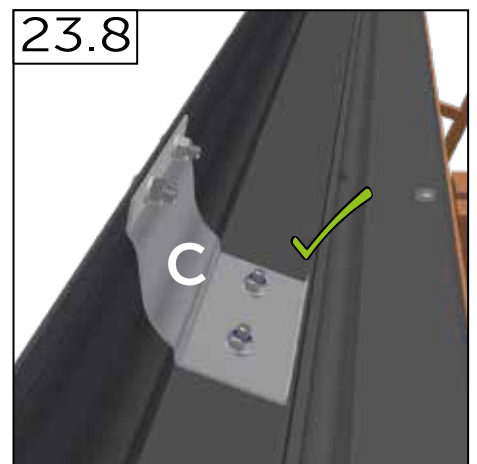
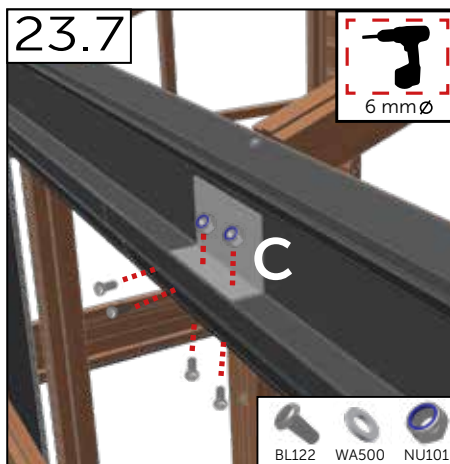
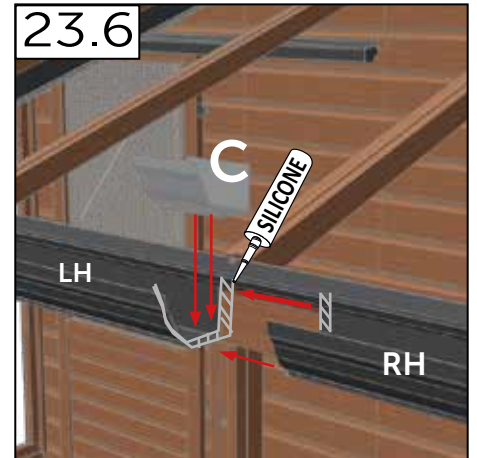
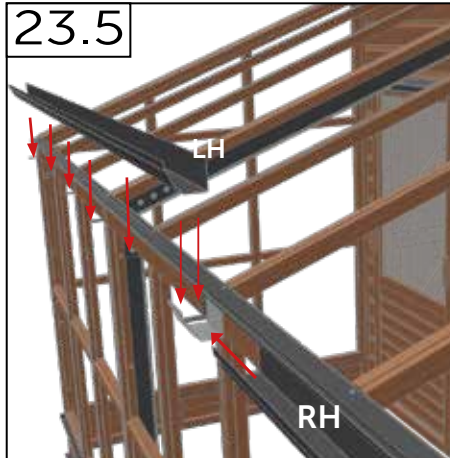

24.0

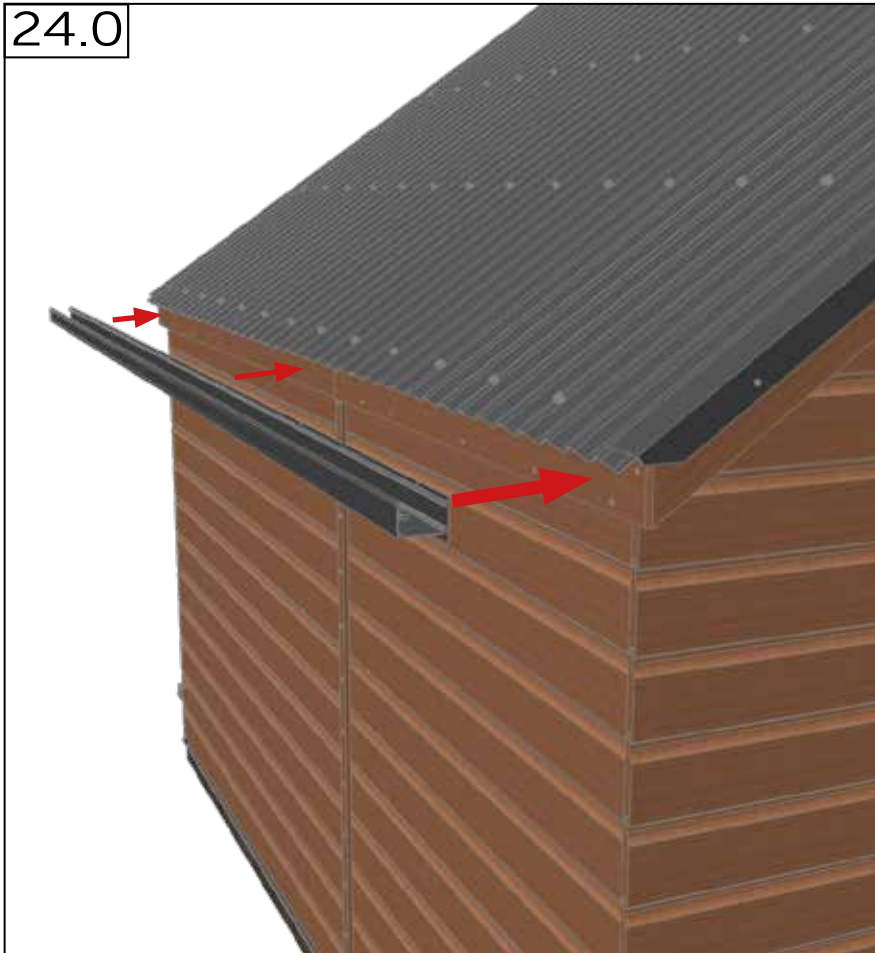



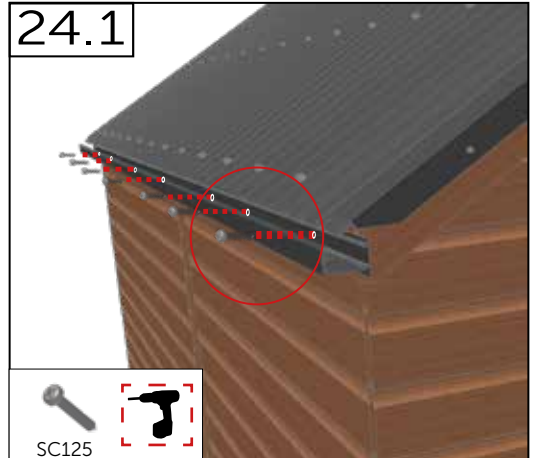







24.1



24.2



	#	mm
	LH AL2014	-
	RH AL2014	-
	C AL3018	-
	B AL3051	-
	PT200	MALE FEMALE
	BL122	M6 x 16
	WA500	M6
	NU101	M6
	PT204	-
	SC121	4.2 x 95

24.3

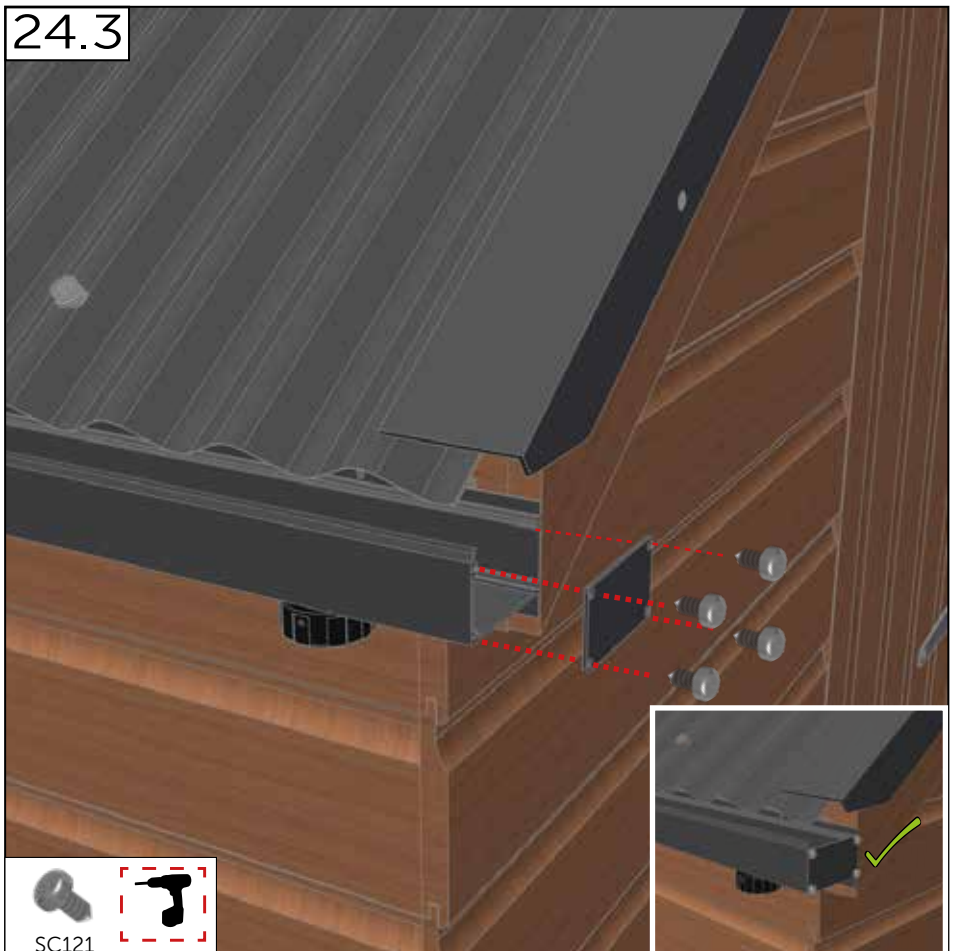

Trims (Shed Side - Extension Length Only) - Garnitures - Trims - Schnitte
 - Trimmer - Adornos

25.0

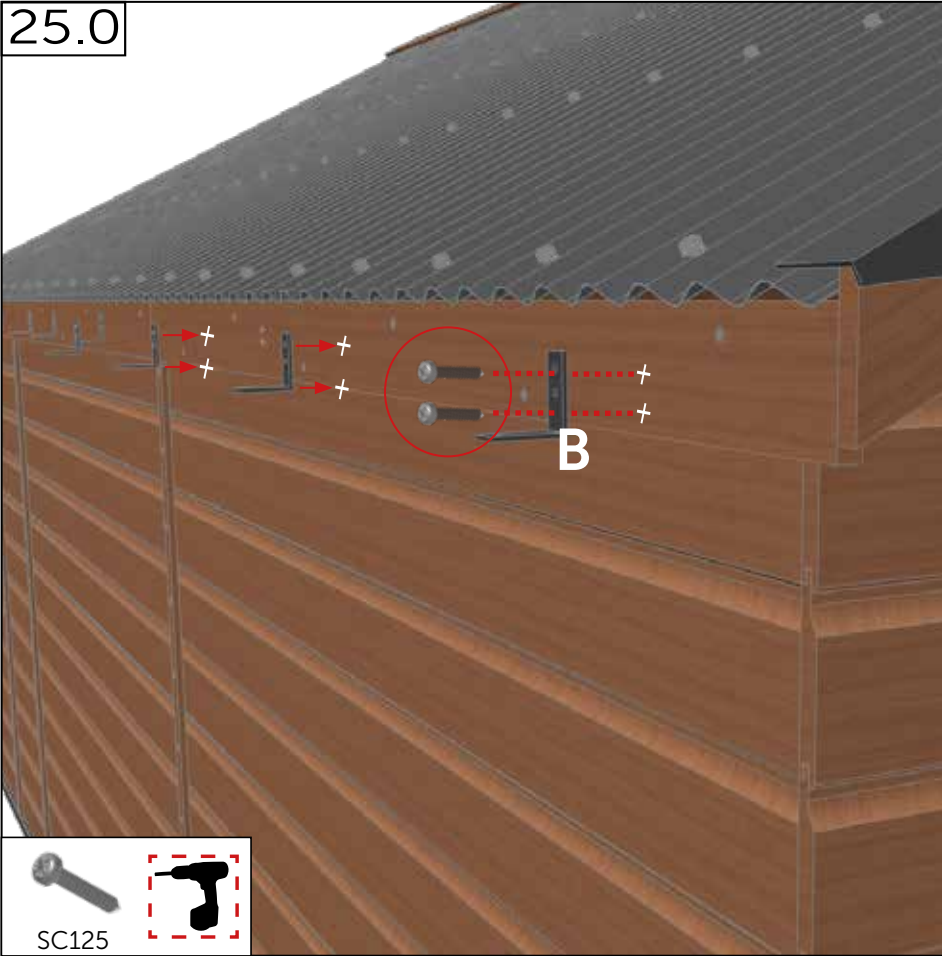

25.1

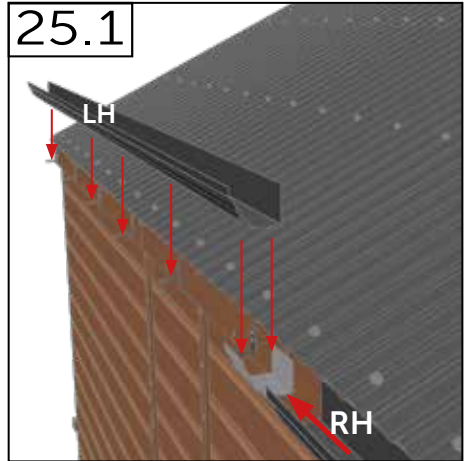

25.2

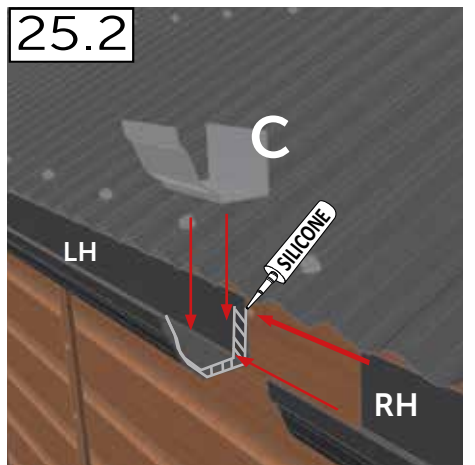

25.3

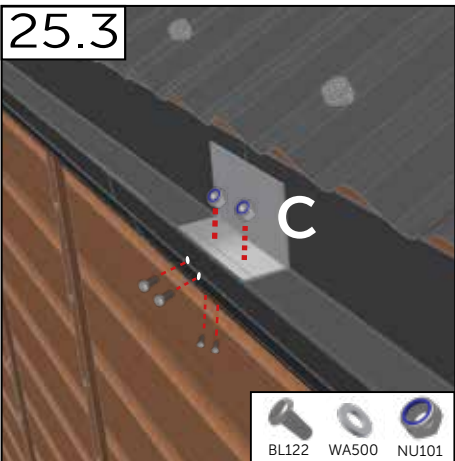

25.4

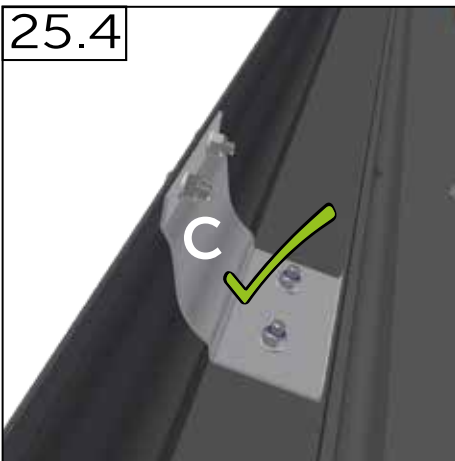

25.5



25.6

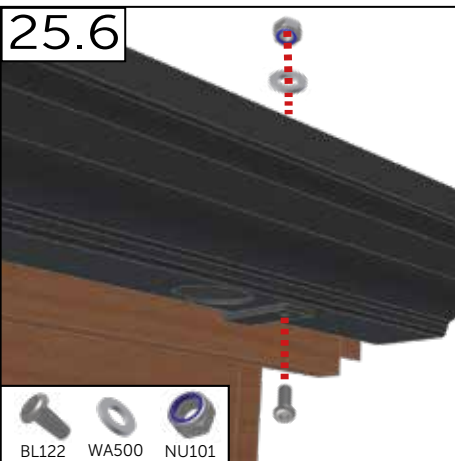

25.7

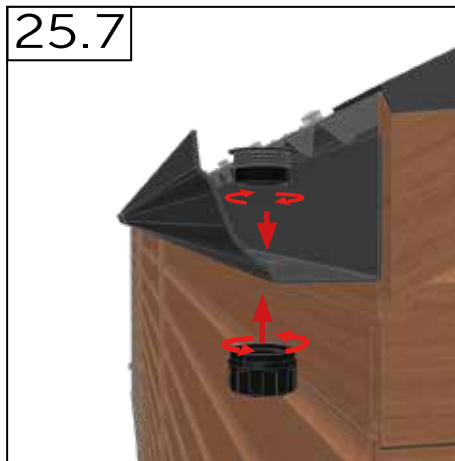

25.8

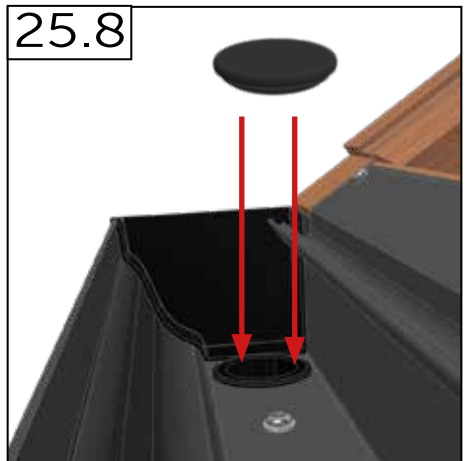

26.0

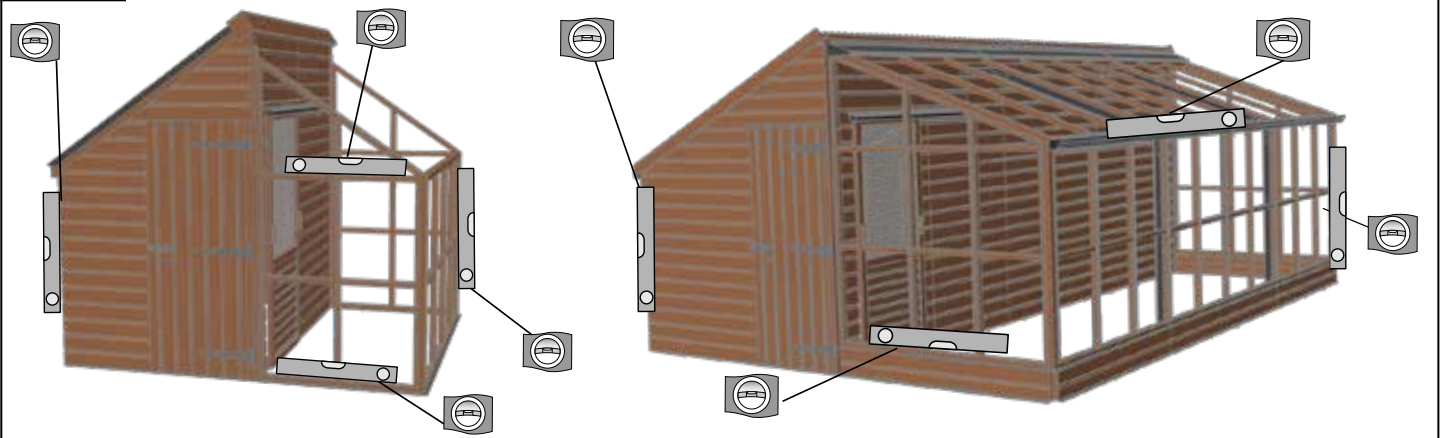

26.0

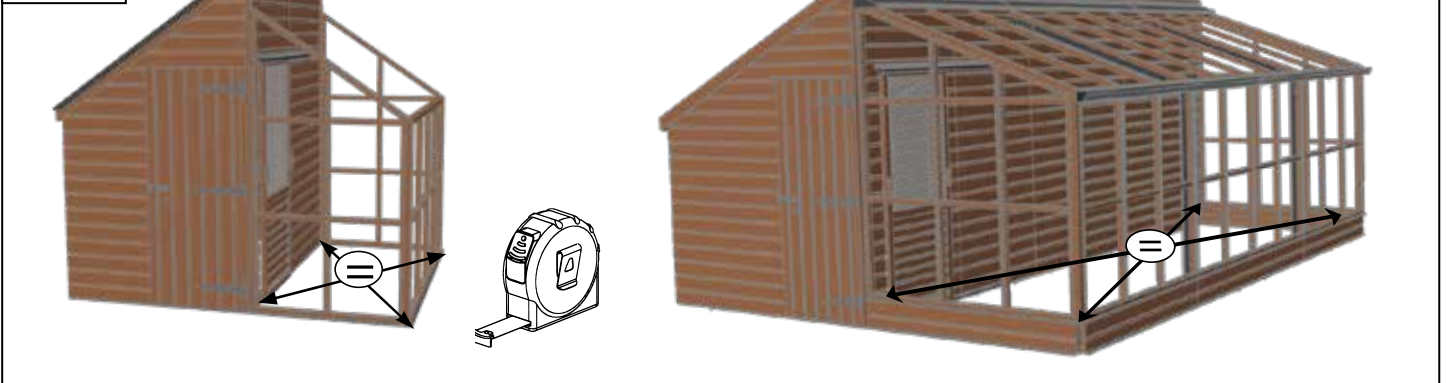

	#	mm
	SC058	4.8 x 100
	WA501	-
	FX200	-

26.1

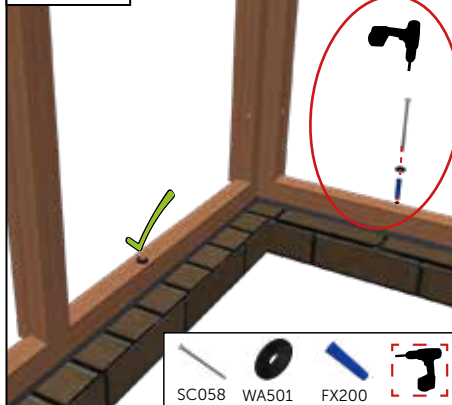

26.2

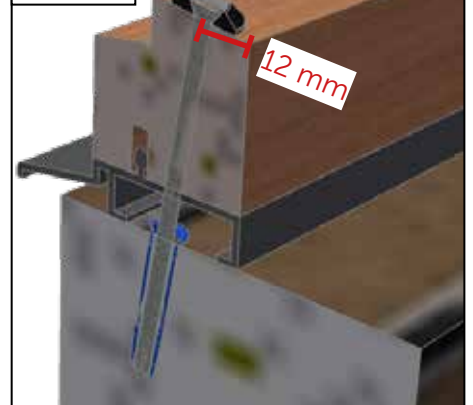

26.3

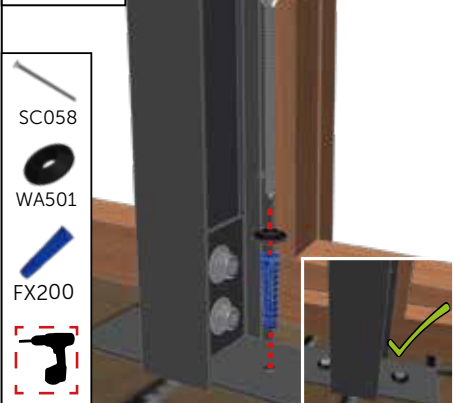

26.4

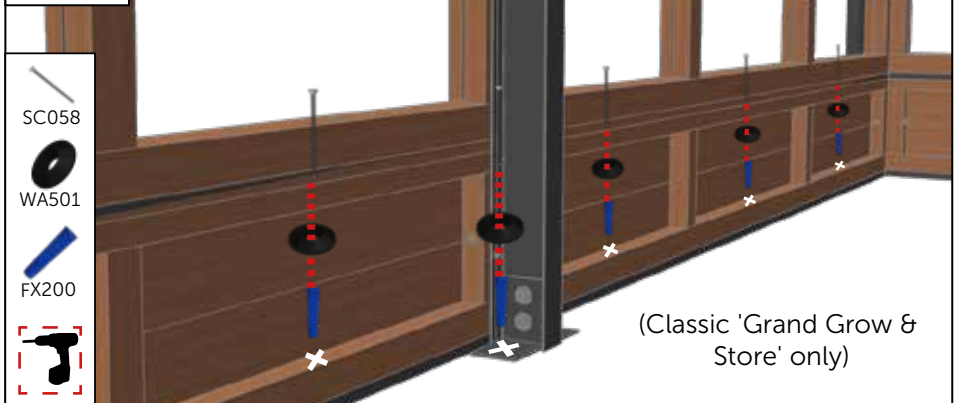

27.0

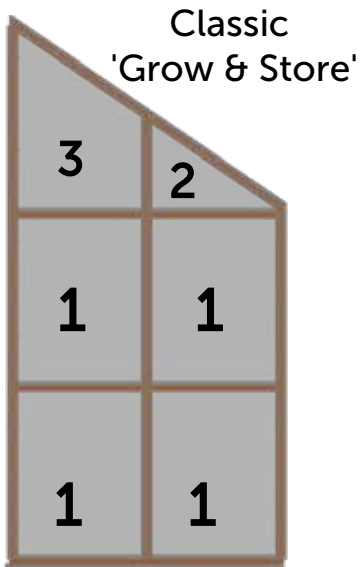

- 1. 0545 x 0717
- 2. 0545 x 0388
- 3. 0545 x 0780

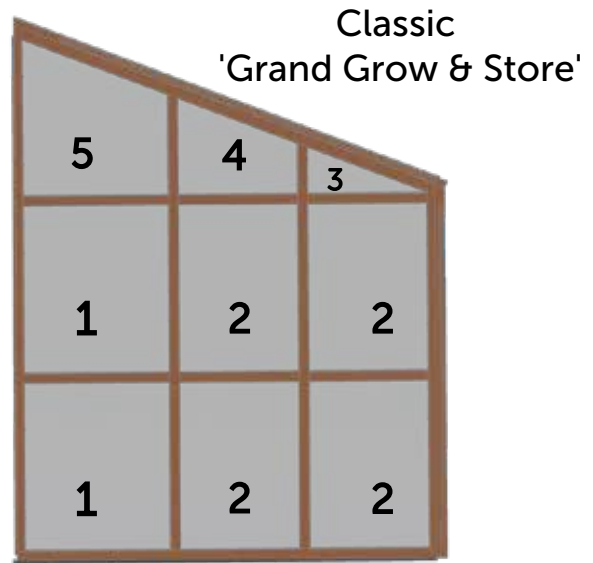

- 1. 0660 x 0717
- 2. 0545 x 0717
- 3. 0545 x 0216
- 4. 0545 x 0425
- 5. 0660 x 0675

27.1

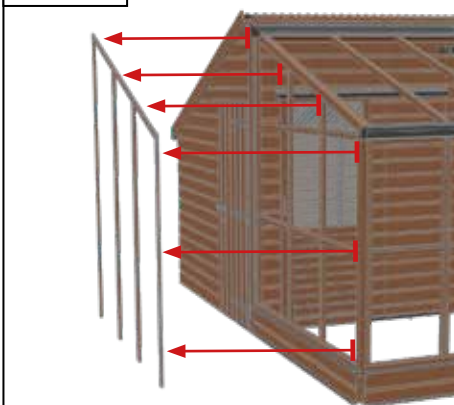

27.2

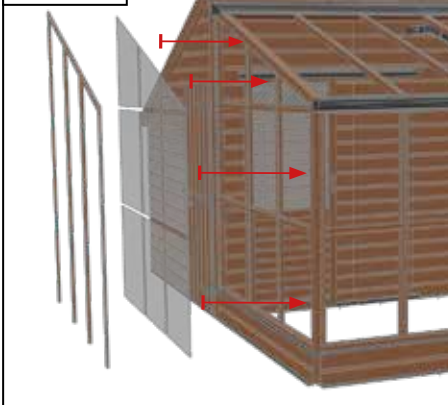

27.3

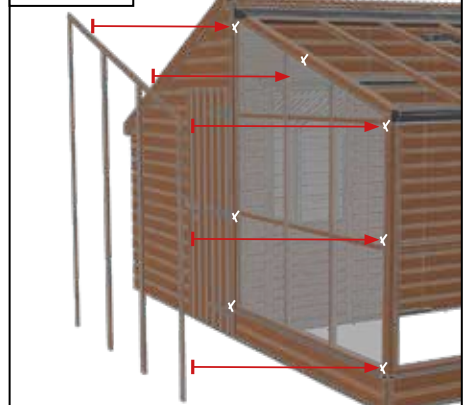

	#	mm
	GLASS	-
	A AL2009	-
	SC125	4.2 x 25
	SC305	3.5 x 32
	WA300	No. 6

27.4

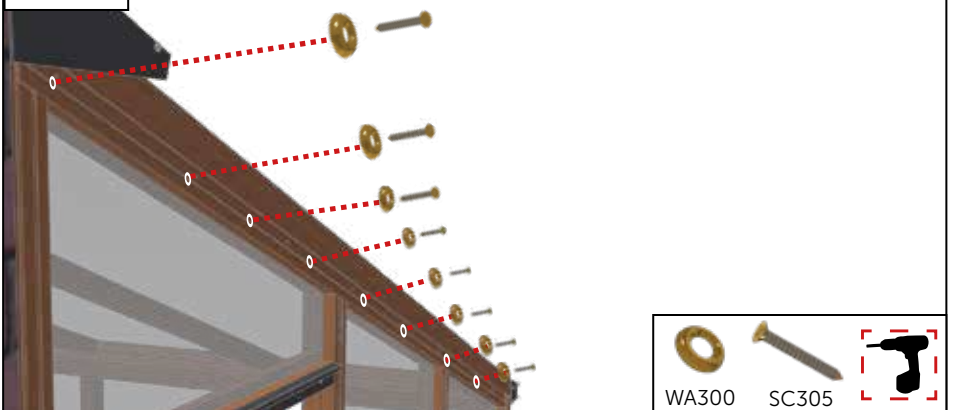

Glazing - Vitrage - Inglasung - Verglasung - Innglassing - Acristalamiento - Glasering

28.0



'Grow & Store'

1. 0545 x 0717
2. 0589 x 1310
3. 0555 x 1310
4. 0570 x 1310

'Grand Grow & Store'

1. 0545 x 0717
2. 0589 x 1863
3. 0555 x 1863
4. 0570 x 1863

'Grow & Store'

1. 0545 x 0717
2. 0589 x 2352
3. 0555 x 2352
4. 0570 x 2352

'Grand Grow & Store'

1. 0545 x 0717
2. 0589 x 1502
3. 0555 x 1502
4. 0570 x 1502

28.1



28.2



28.3

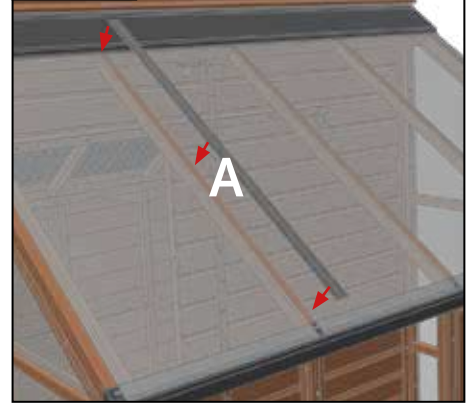

28.4

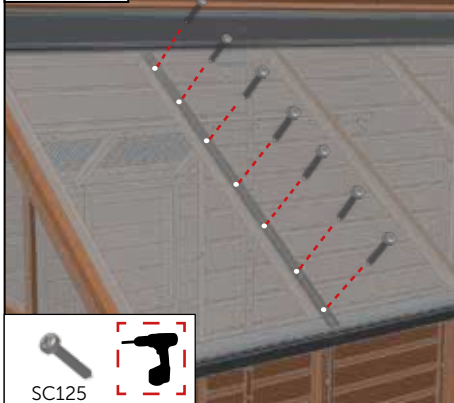

28.5

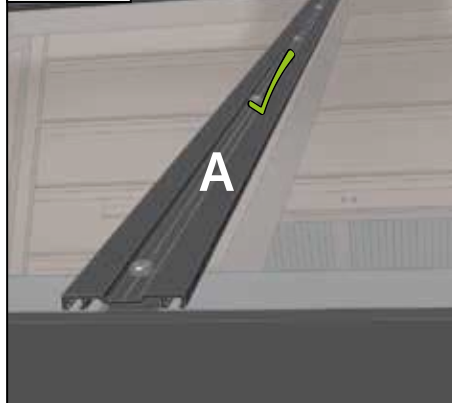

28.6

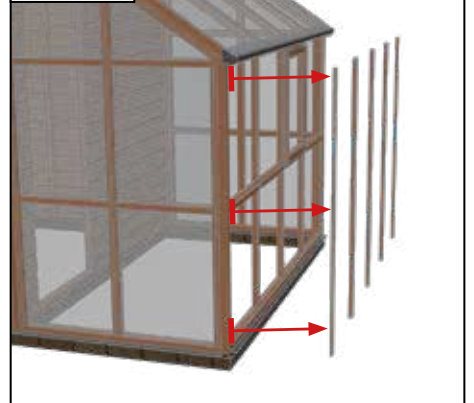

28.7

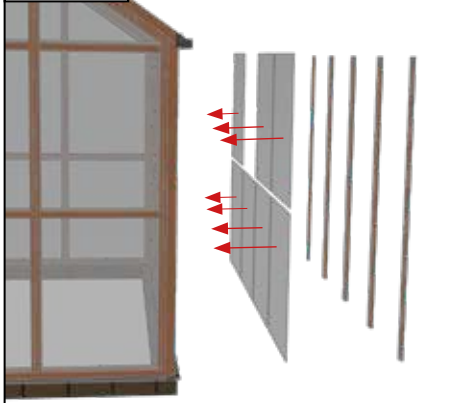

28.8

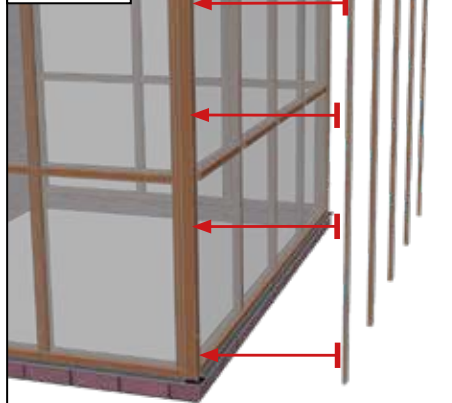

28.9

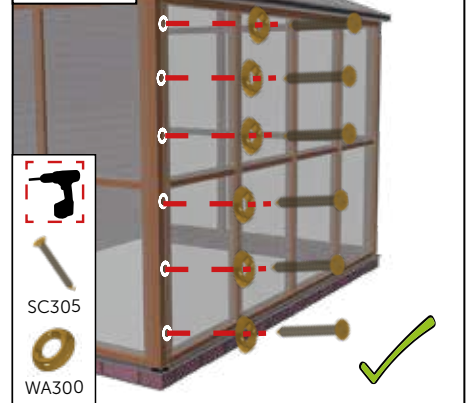

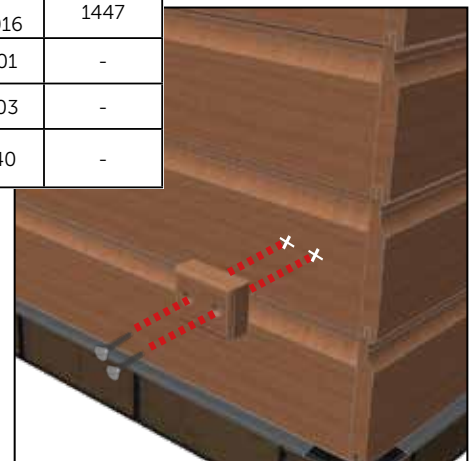
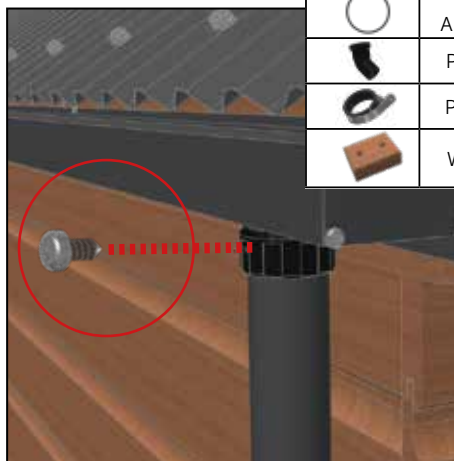
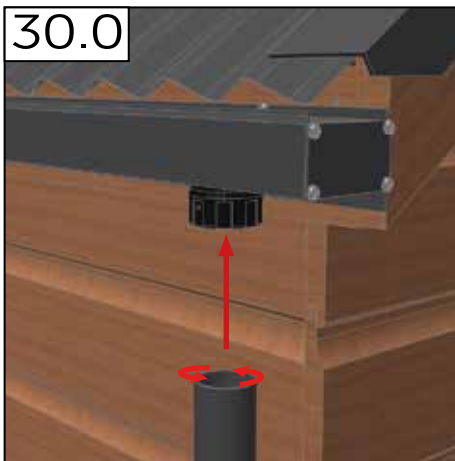
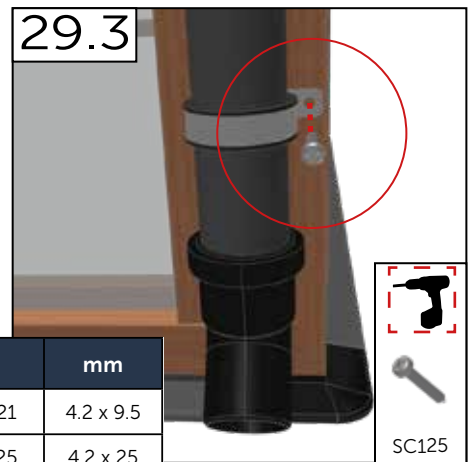
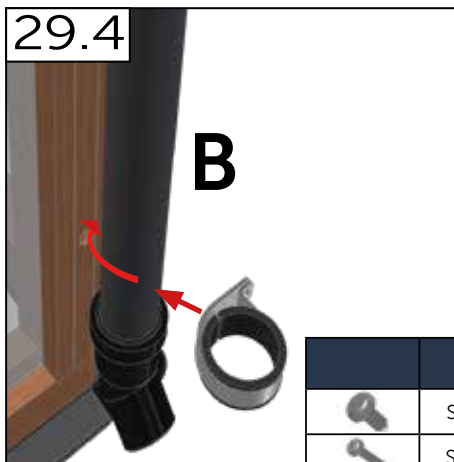
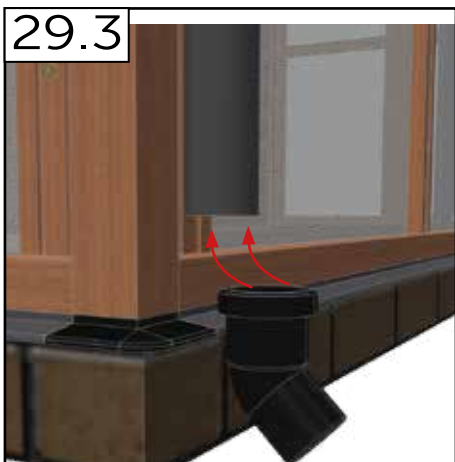
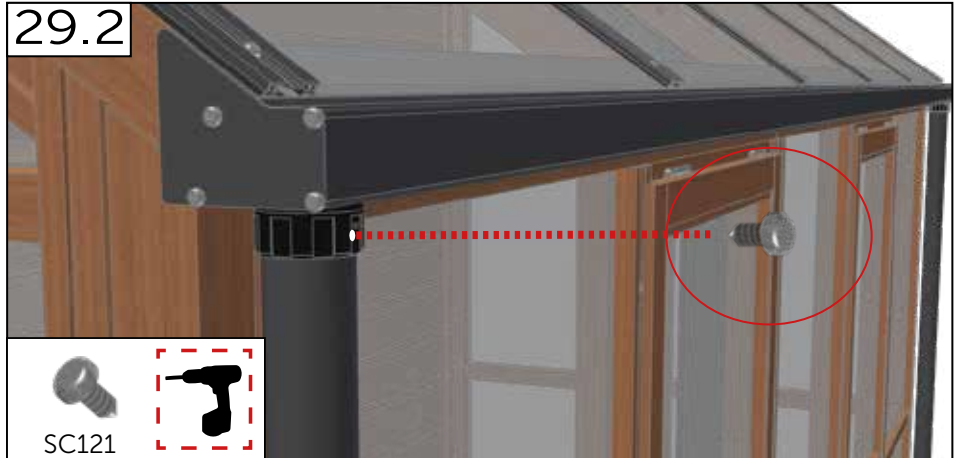
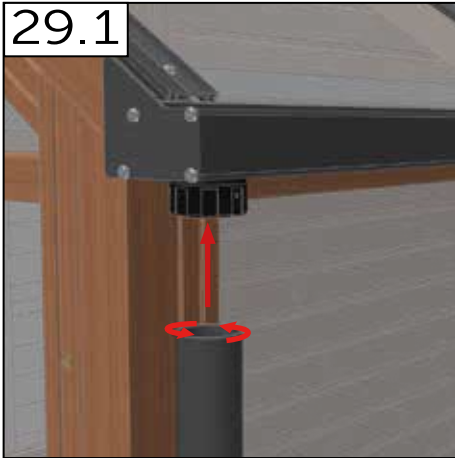

	#	mm
	SC121	4.2 x 9.5
	SC125	4.2 x 25
	B AL2016	1447
	PT201	-
	PT203	-
	W440	-





G A B R I E L A S H

www.gabrielash.com

As part of our policy of continuous development and improvement.
We reserve the right to modify any of the information set out within this document and any related documentation at any time without notice.

This product is delivered by a company in the Juliana Group - www.juliana.com

©The Royal Horticultural Society. The Royal Horticultural Society, and its logo, are trade marks of The Royal Horticultural Society.

(Registered Charity No. 222879/SC038262) and used under licence from RHS Enterprises Limited.