

# Installation Guide



GABRIEL ASH

Classic Lean to 'Baby Four'



Classic Lean to 'Six'



Classic Lean to 'Eight'

















Classic Lean to 'Ten'



RHS



	
	4 - 5
	6 - 7
	8 - 9
	10 - 11
	12 - 17
	18 - 21
	22 - 25
	26 - 29
	30
	31 - 33
	34 - 36
	37

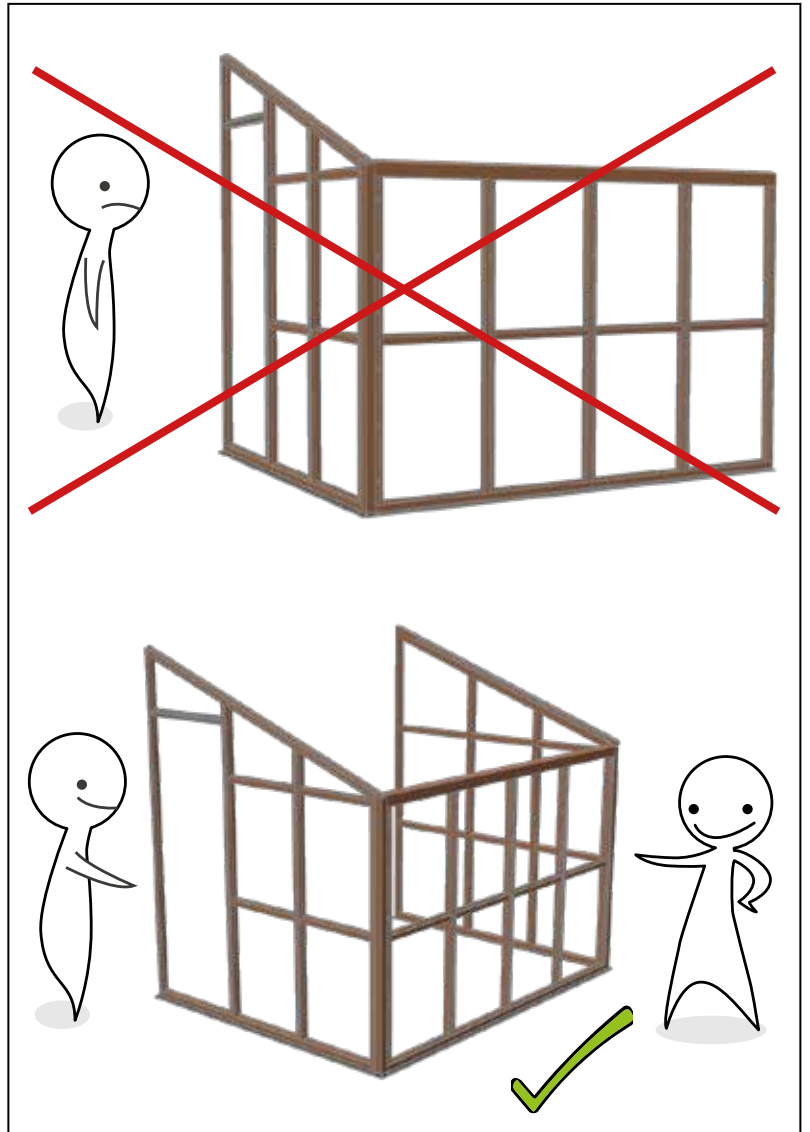

# Portal Frame-Portique-Portal ram-Portalrahmen-Portalramme -Marco del pórtico - Portal ramme



	#	mm
	AL3067	-
	AL3060	-
	AL3059	-
	A	1559
	B	0851
	B	1199
	B	1596
	B	1894
	C	0341
	BL153	M8 x 20
	WA205	M8
	NU102	M8

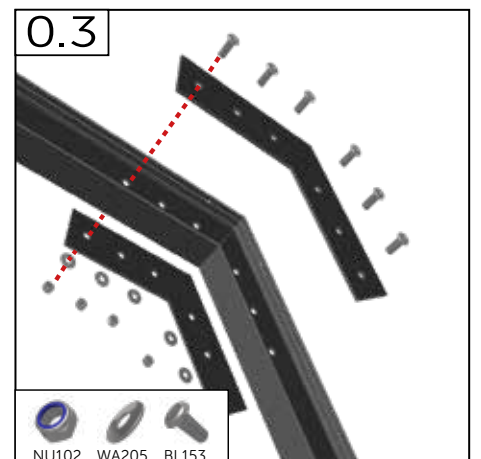
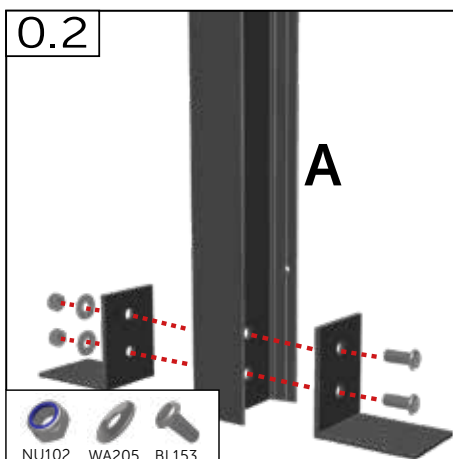
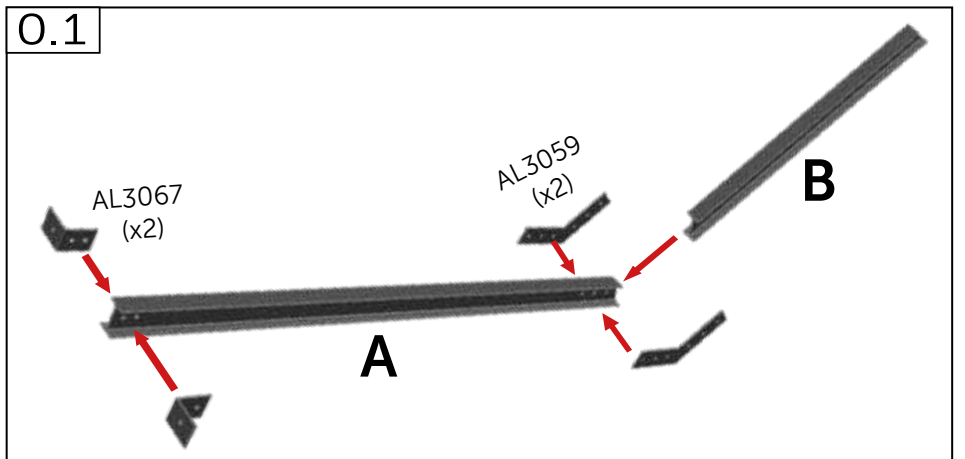



Portal Frame-Portique-Portal ram-Portalrahmen-Portalramme  
-Marco del pórtico - Portal ramme

0.4

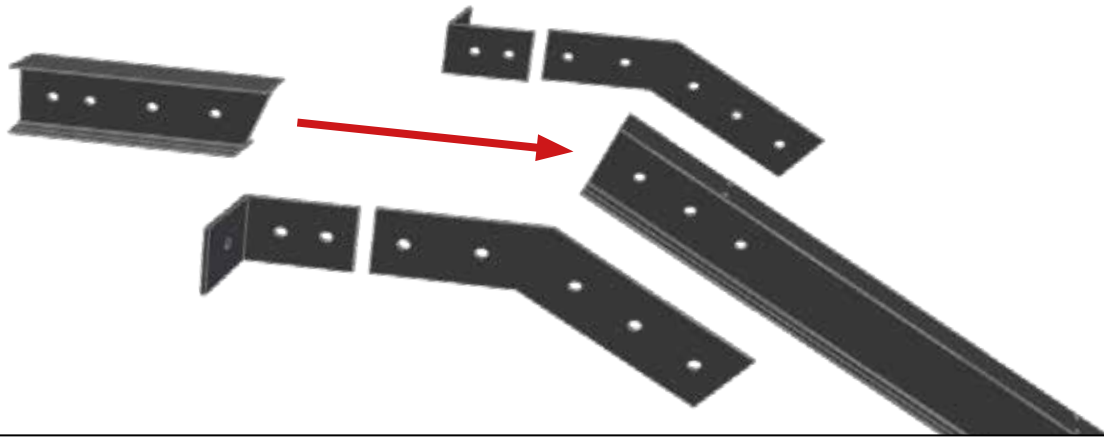

0.4

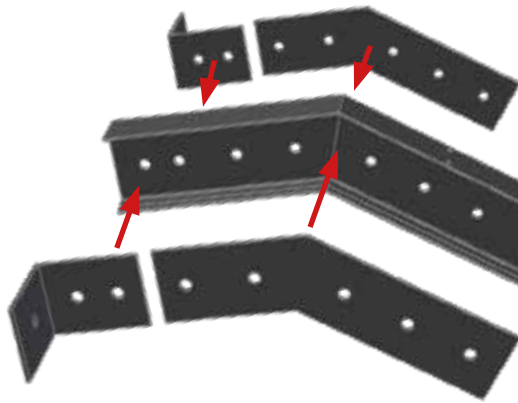



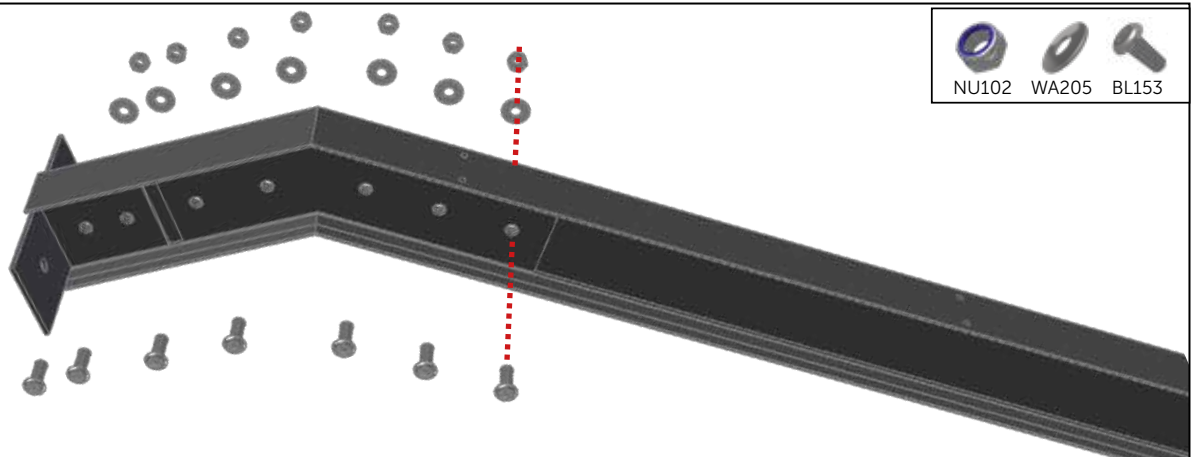



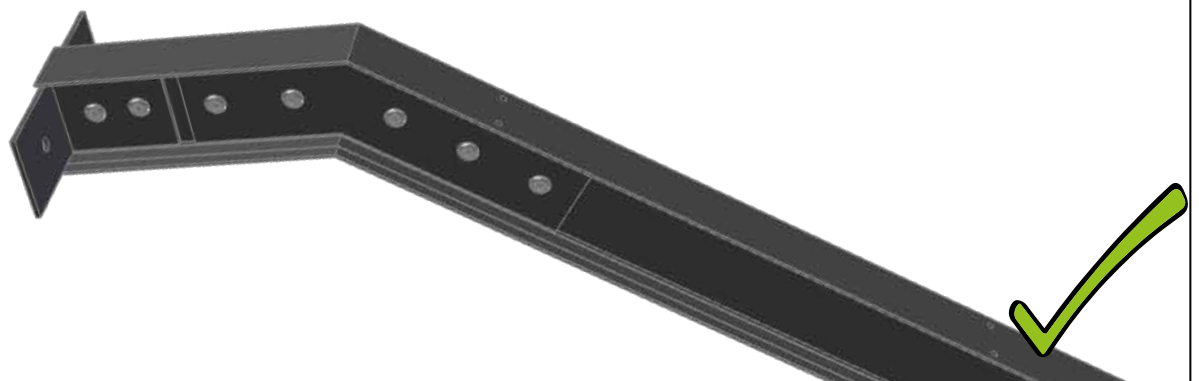















0.4



0.4



# Gables-Pignons-Gavlar-Giebel-Gavler-Aguilones-Gavle

	#	mm
	SA8065	Lean To Baby 'Four'
	SA8066	Lean To Baby 'Four'
	SA8067	Lean To Baby 'Four'
	SA8068	Lean To Baby 'Four'
	SA8100	Lean To 'Six'
	SA8101	Lean To 'Six'
	SA8102	Lean To 'Six'
	SA8103	Lean To 'Six'
	SA8105	Lean To 'Eight, Ten'
	SA8106	Lean To 'Eight'
	SA8107	Lean To 'Ten'
	SA8108	Lean To 'Eight, Ten'
	SA8109	Lean To 'Eight'
	SA8110	Lean To 'Ten'
	SA8112	Lean To 'Eight'
	SA8113	Lean To 'Ten'
	SA8115	Lean To 'Eight'
	SA8116	Lean To 'Ten'
	W013-01	-
	W013-02	-
	SC024	4.2 x 38
	SC027	4.2 x 65
	WA301	No. 8

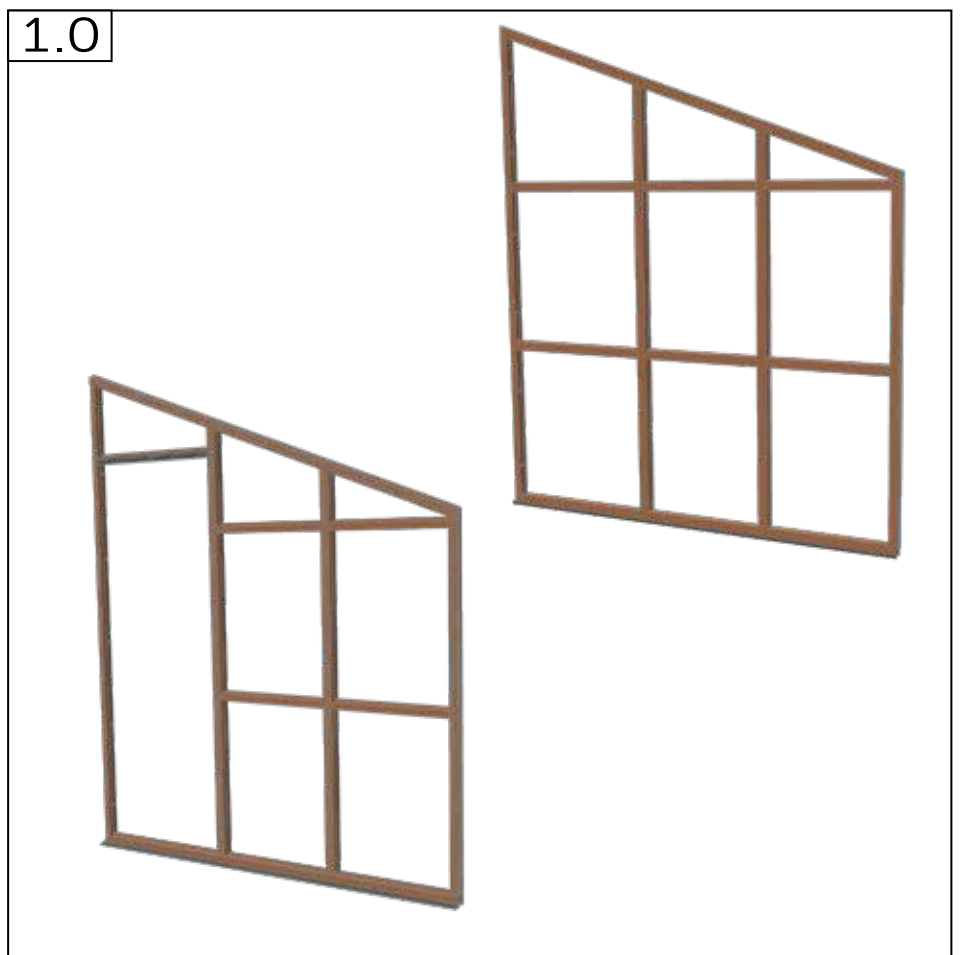
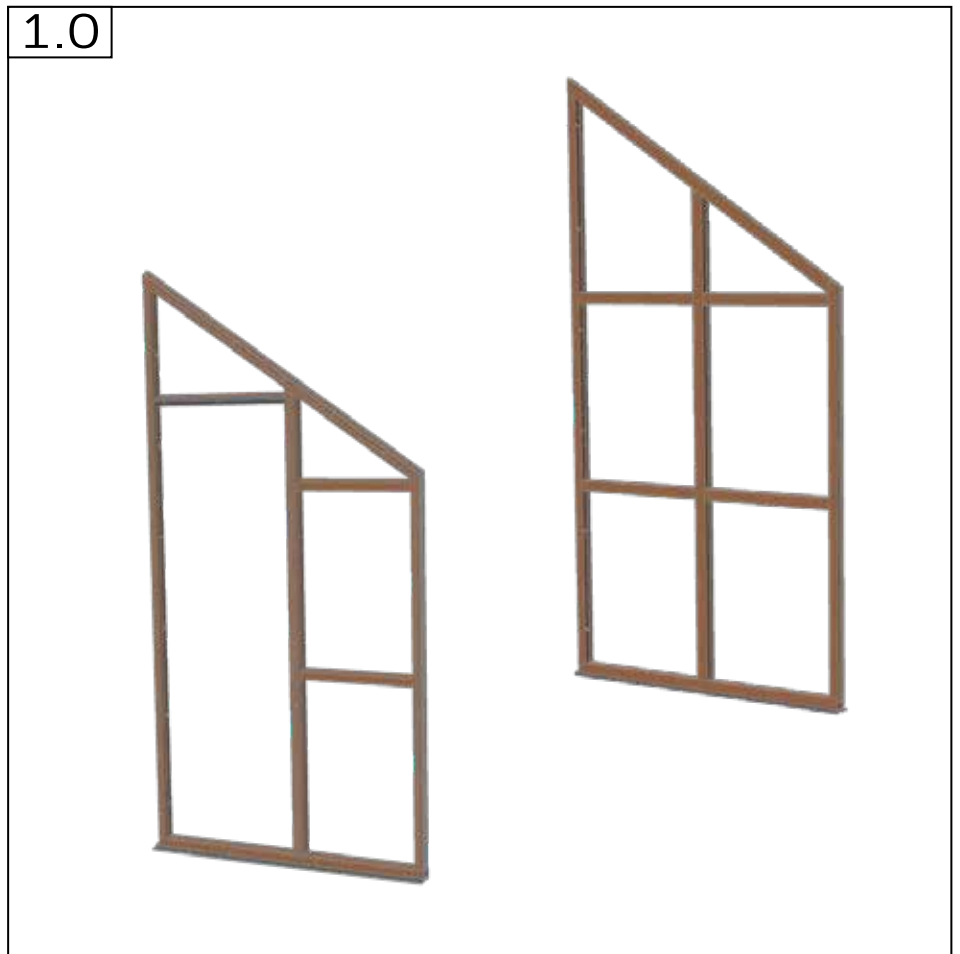

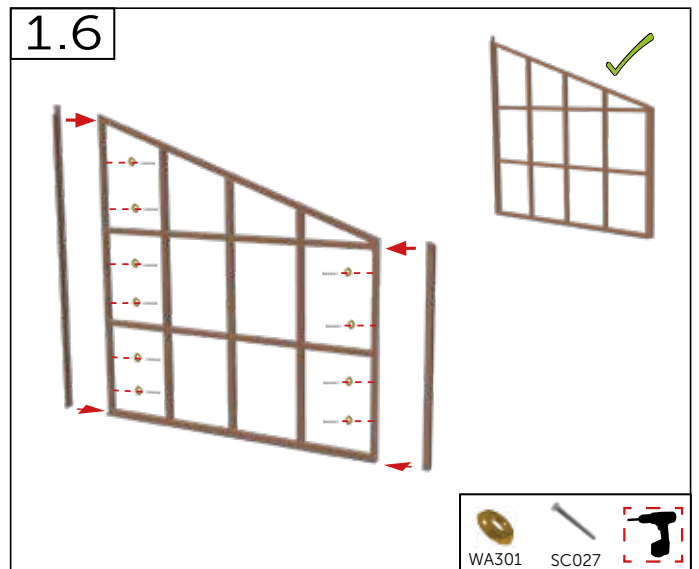
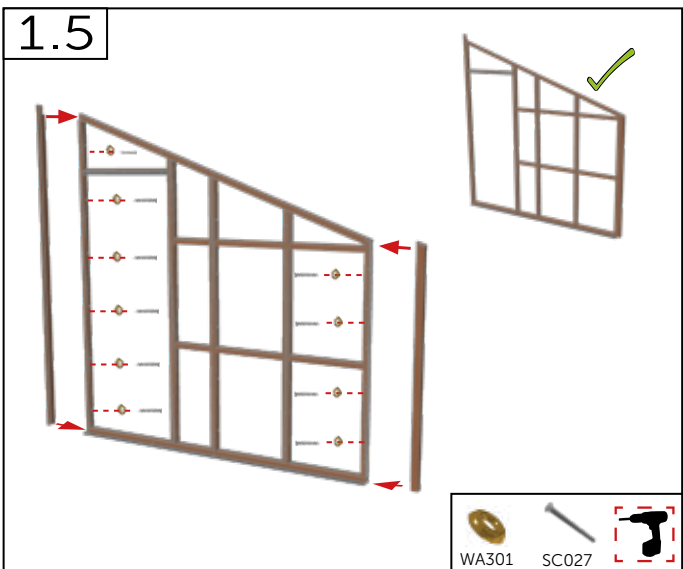
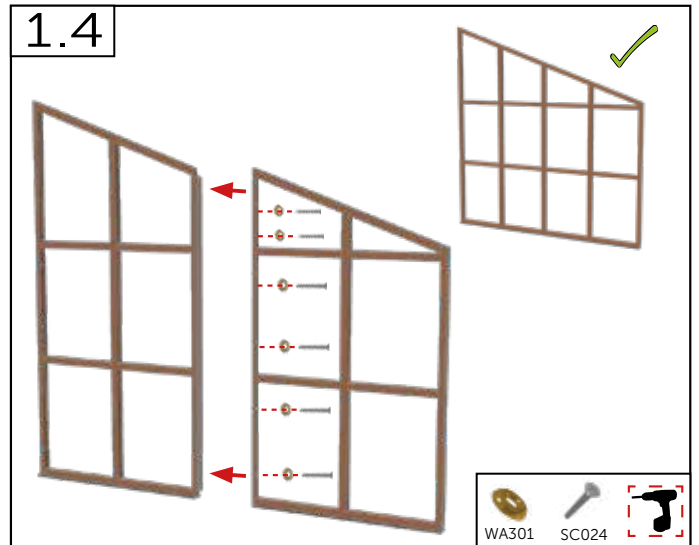
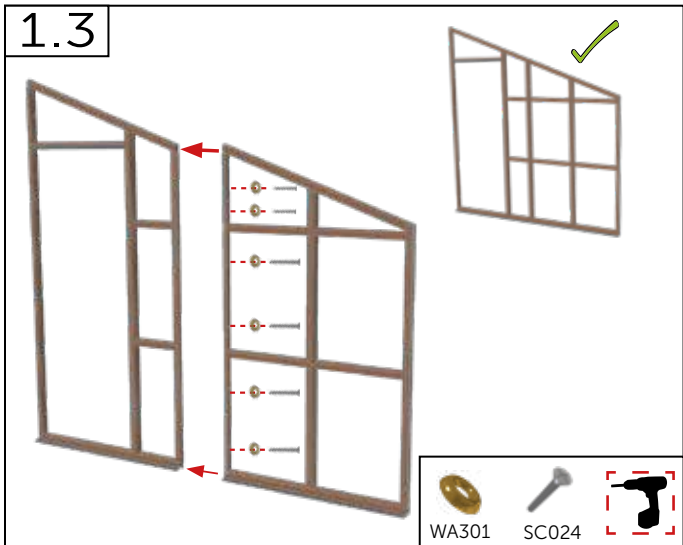
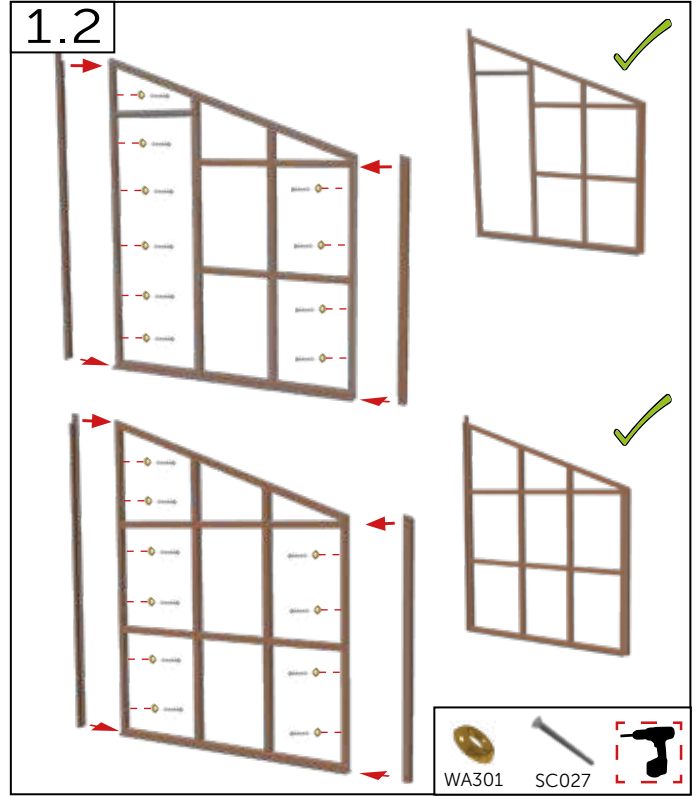
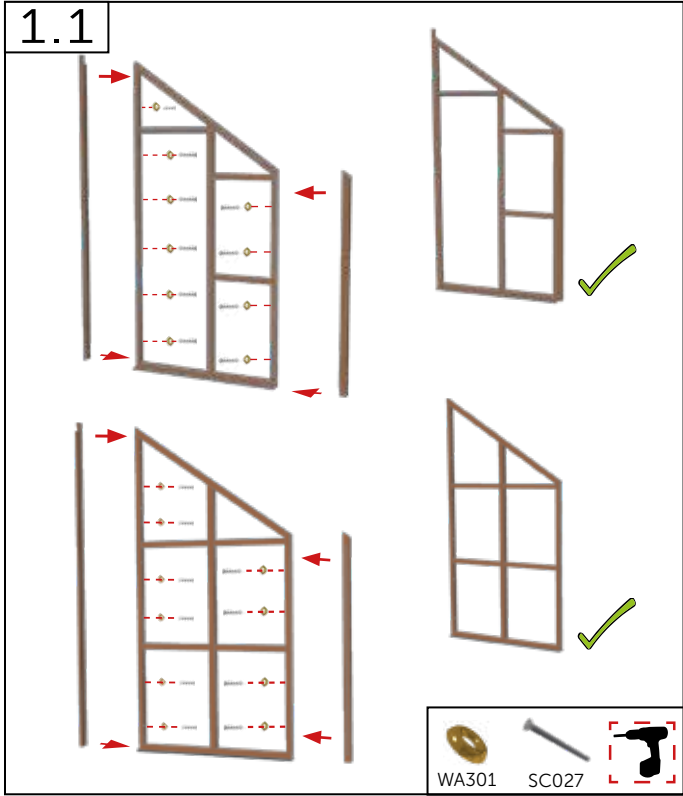

# Gables-Pignons-Gavlar-Giebel-Gavler-Aguilones-Gavle

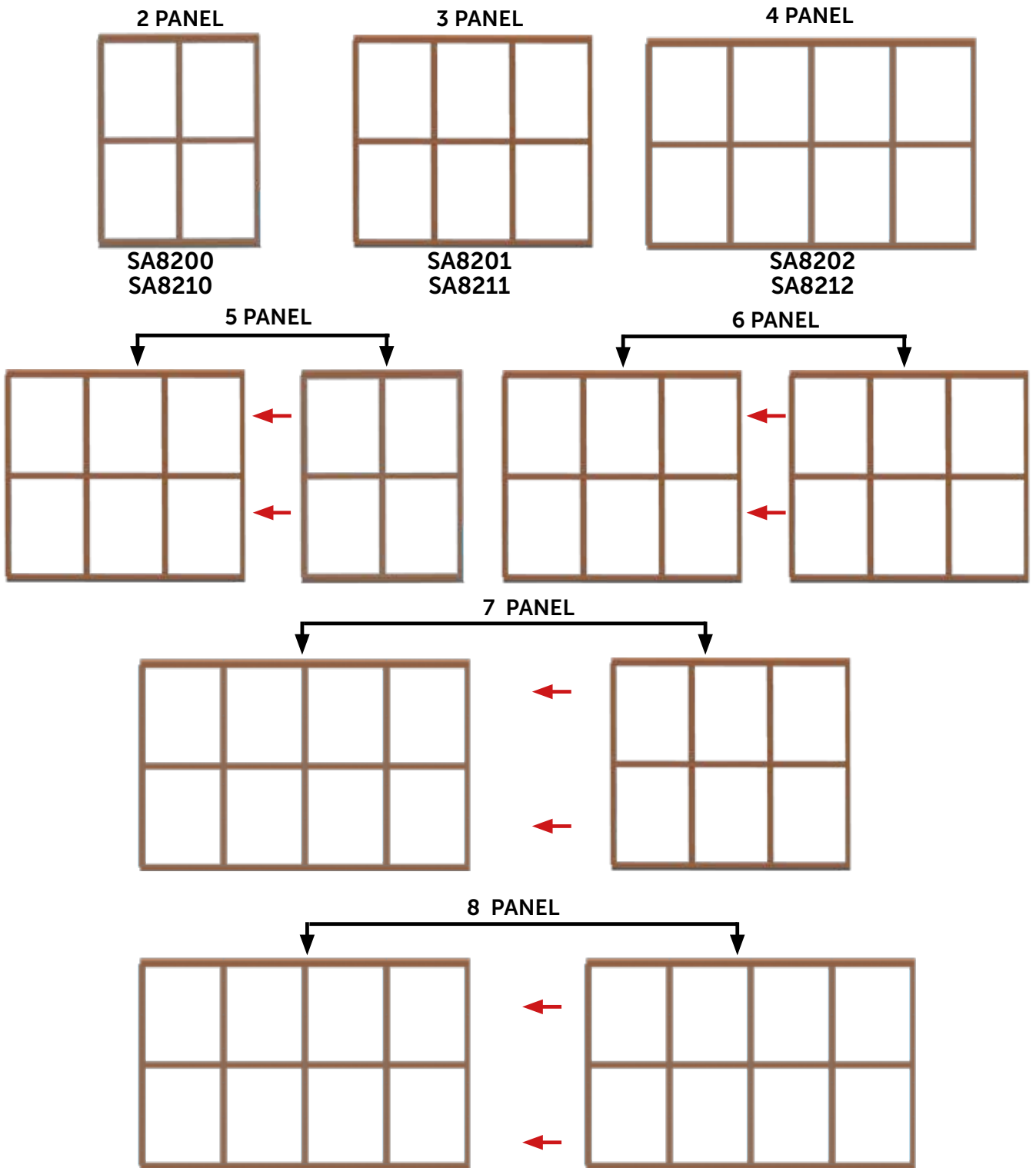

Side Panels - Des panneaux latéraux - Sidpaneler - Seitenleiste  
 - Sidepaneler - Paneles laterales - Sidepaneler

2.0



	#	mm
	SC027	4.2 x 65
	SC301	No. 8

Side Panels - Des panneaux latéraux - Sidpaneler - Seitenleiste - Sidepaneler  
 - Paneles laterales - Sidepaneler

2.0

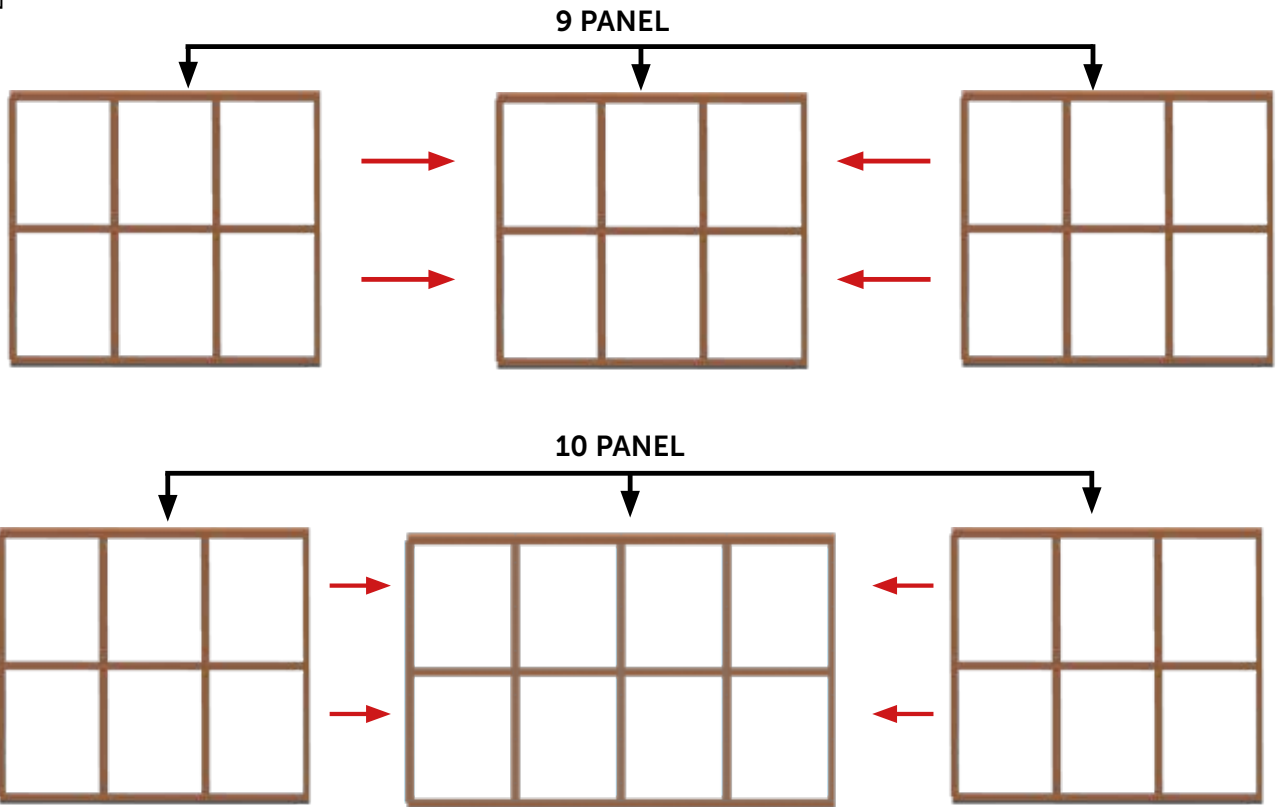

2.1

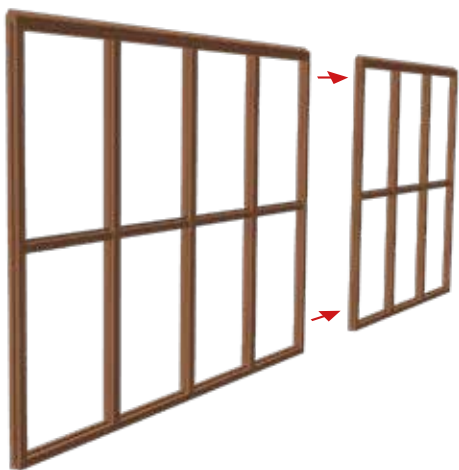

2.2



2.1

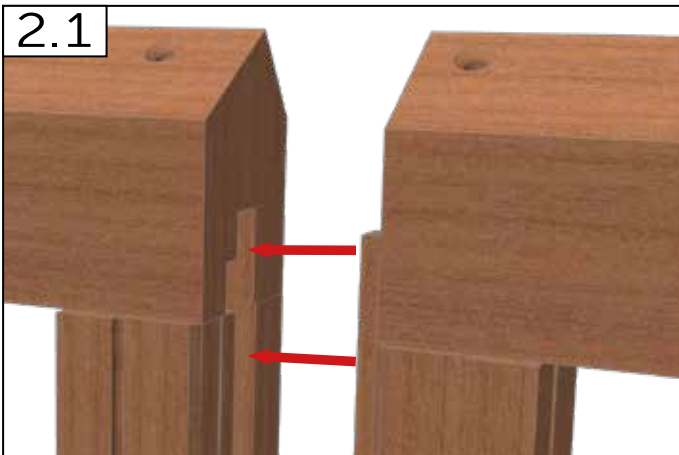

2.2

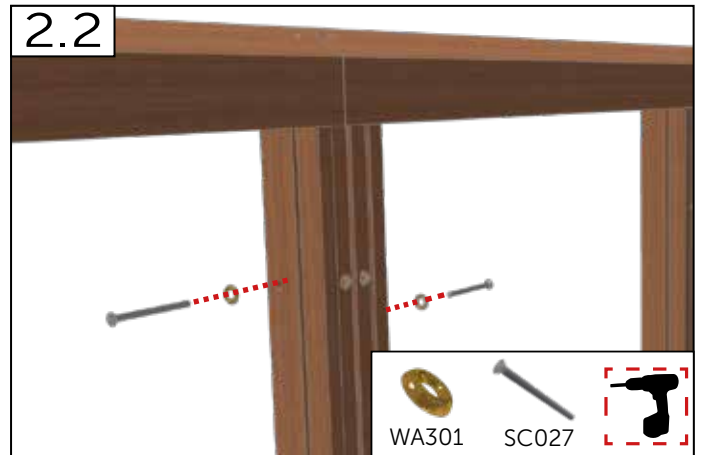

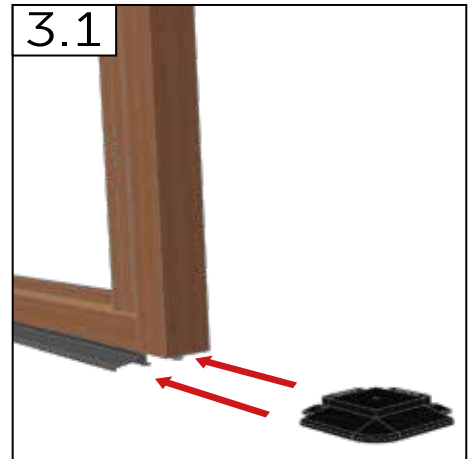
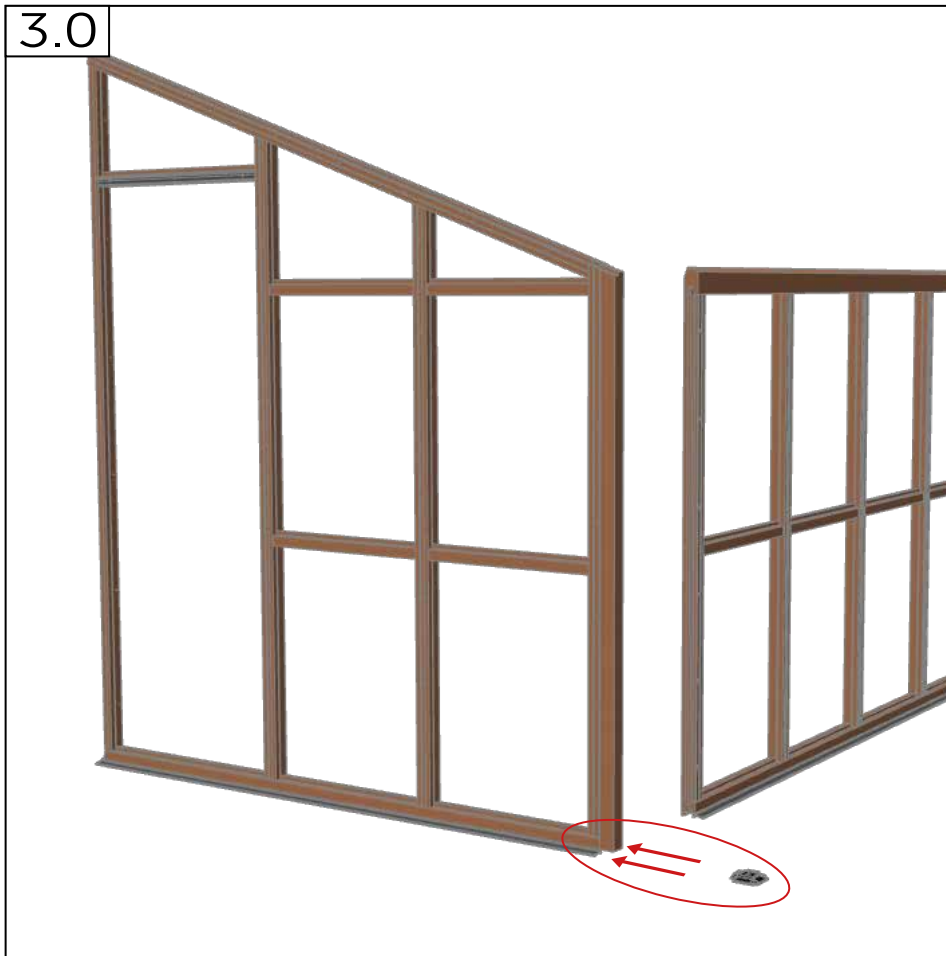

	#	mm
	PT106	-
	SC027	4.2 x 65
	WA301	No. 8

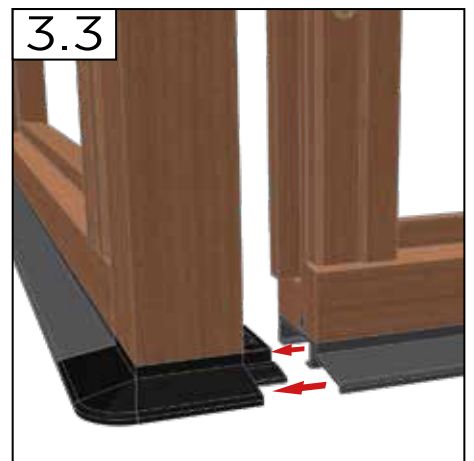
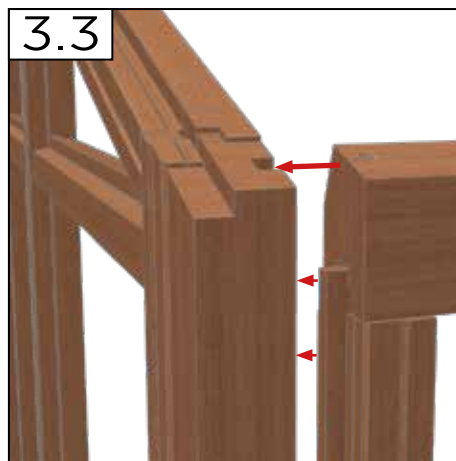
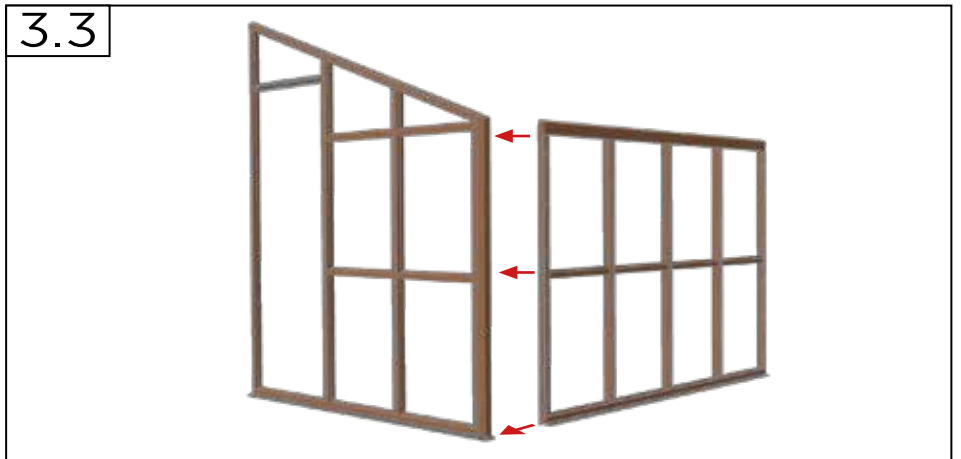

3.4

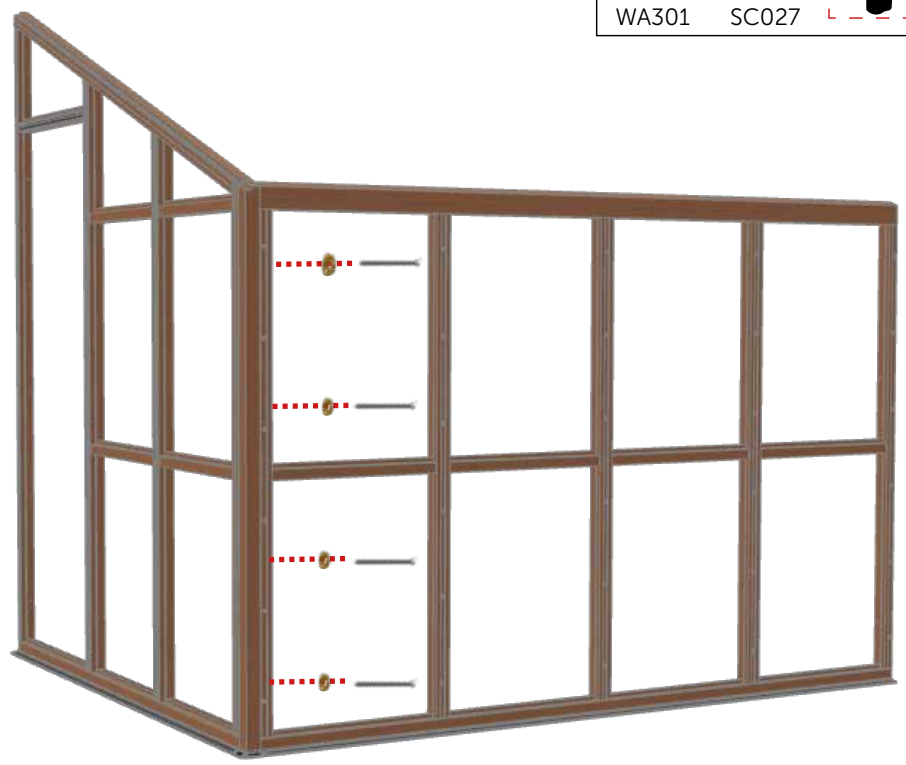
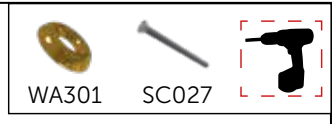

3.5

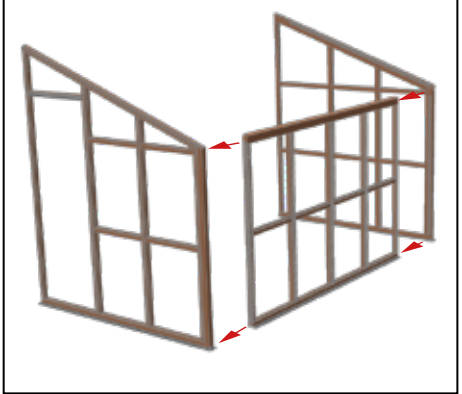

3.6

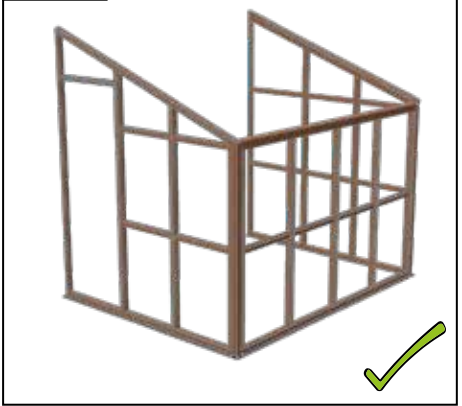

3.7 (Extension Length Only)

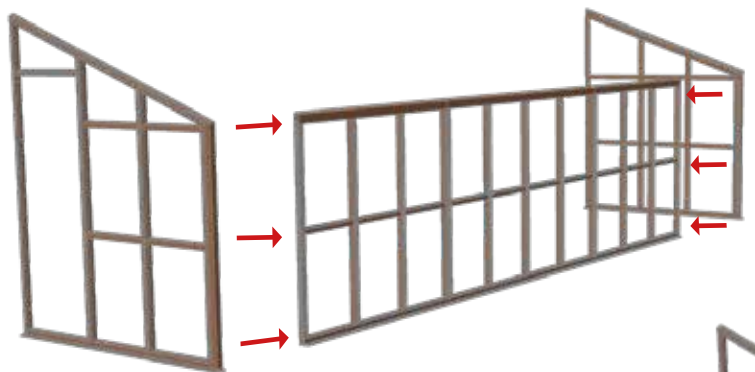



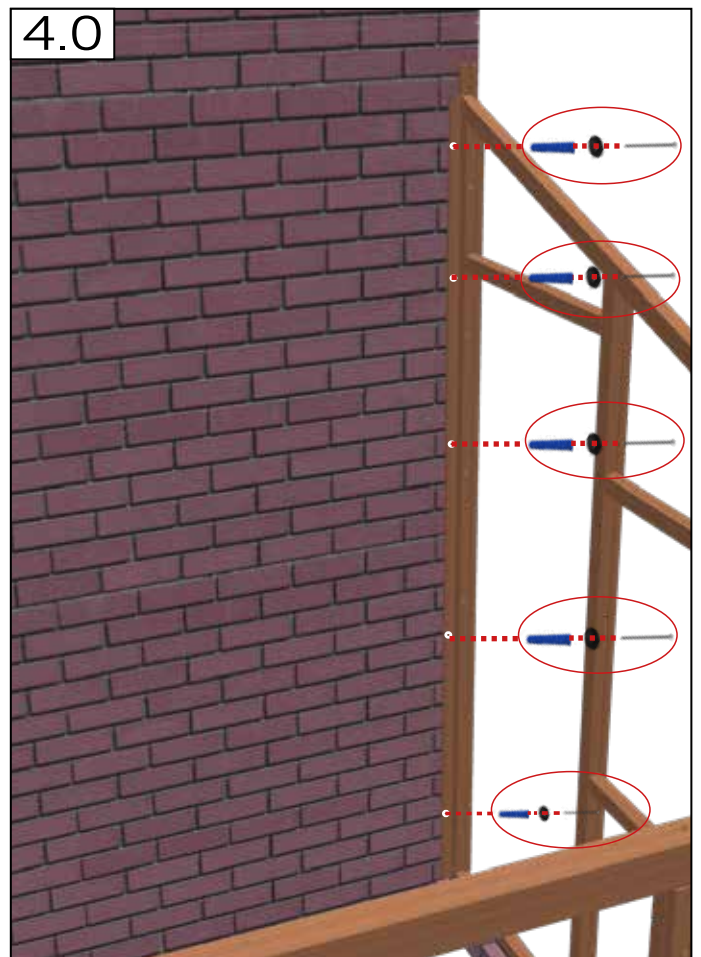
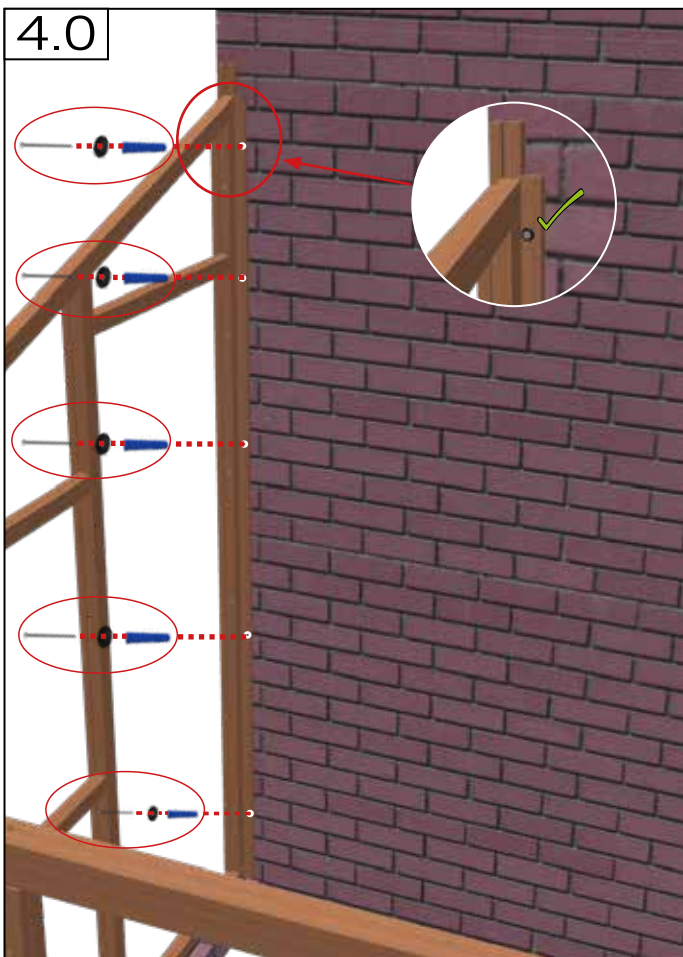
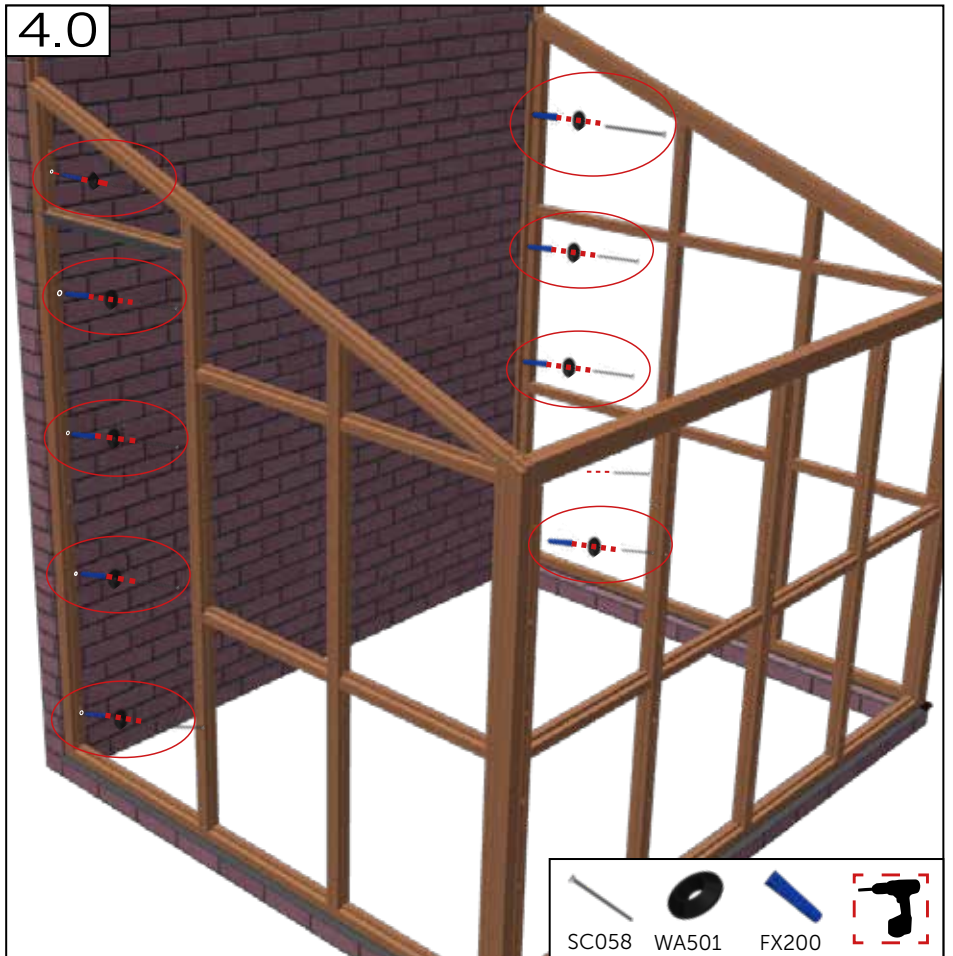





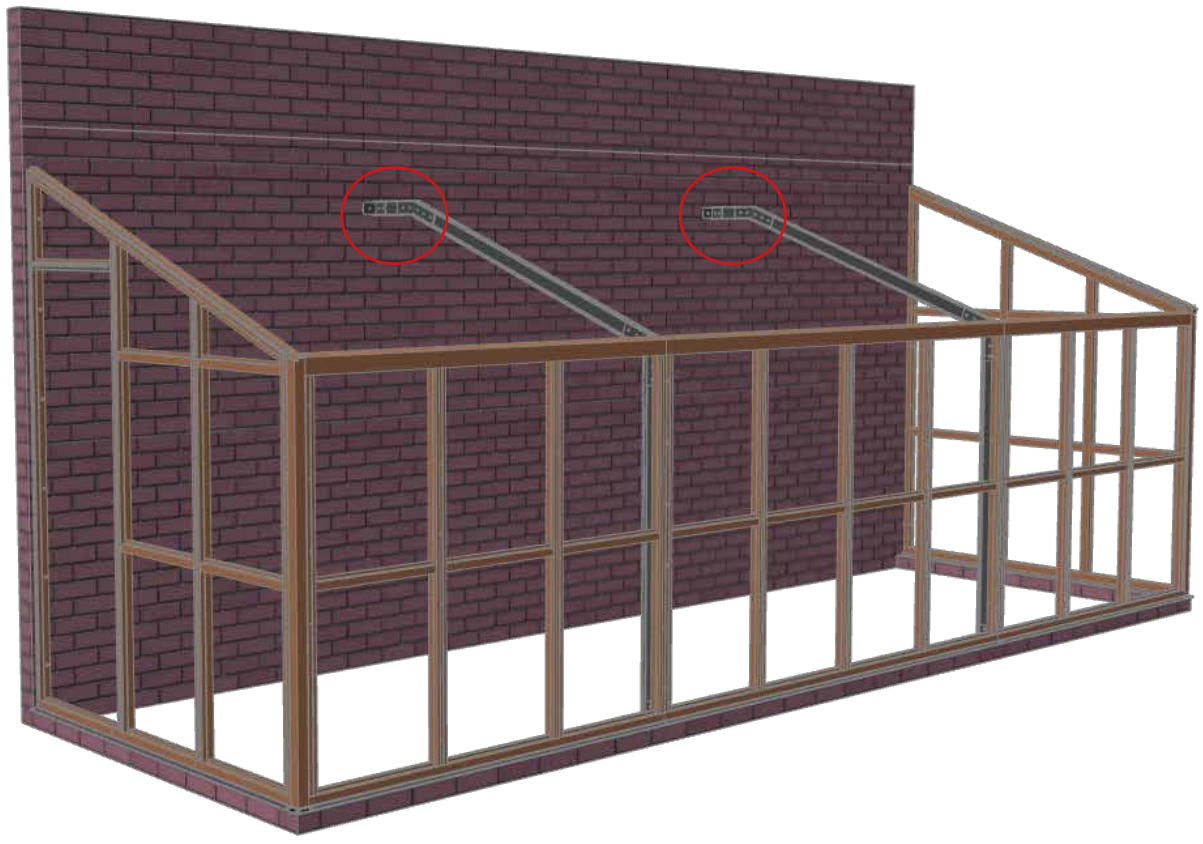

Assemble (Extension Length Only) - Assembler - Montera - Montieren  
 - Montere - Armar - Samle

4.1





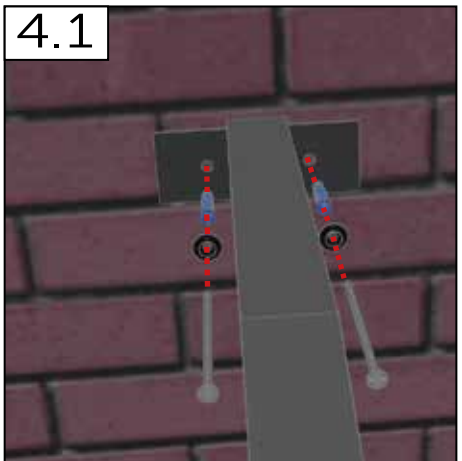
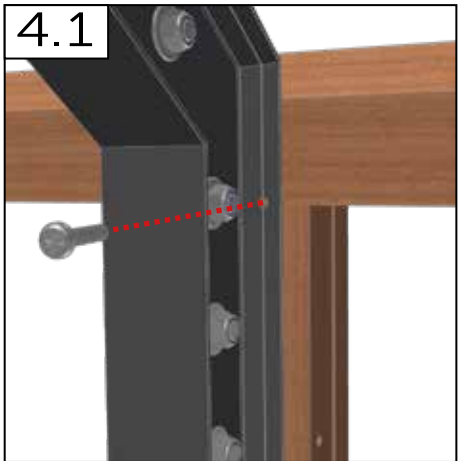
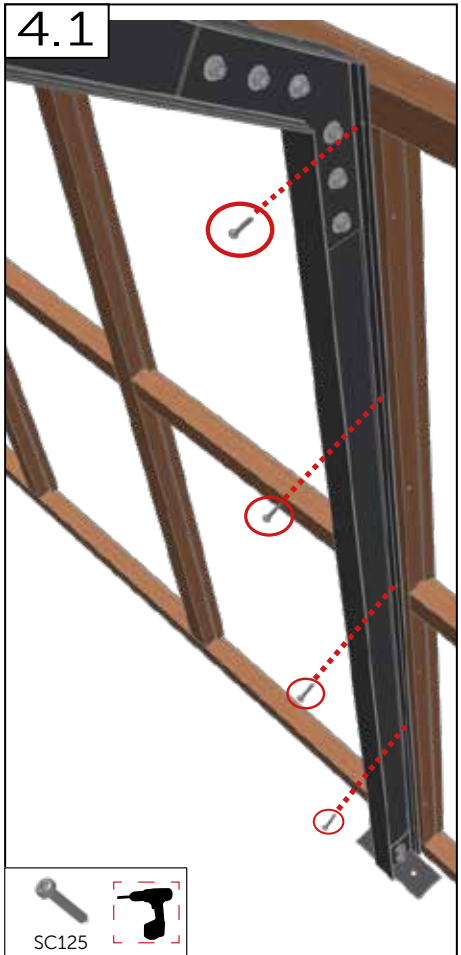

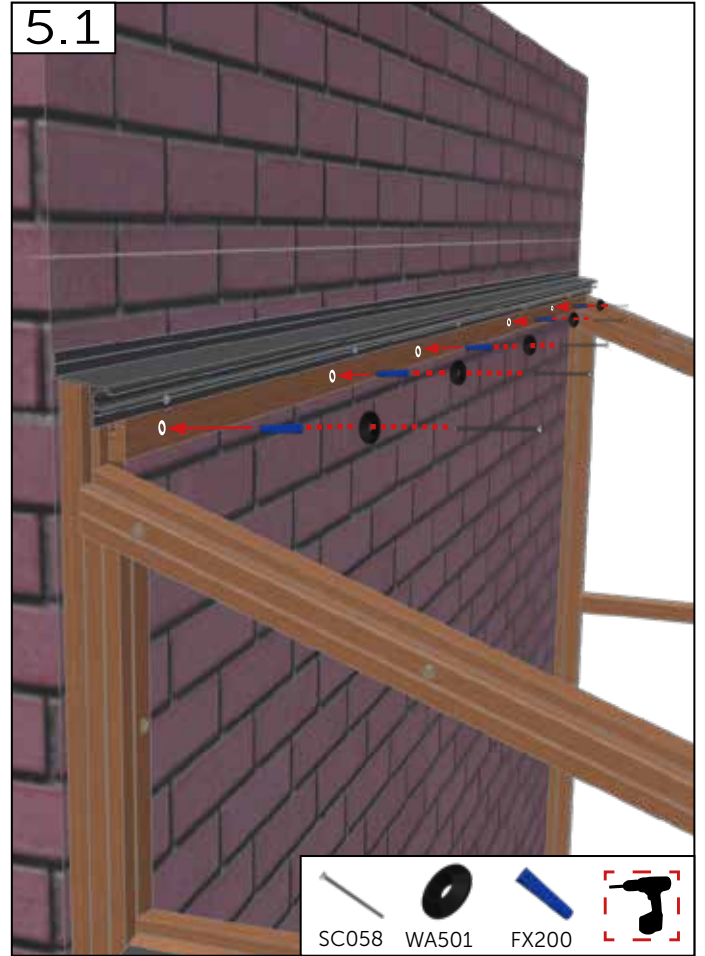
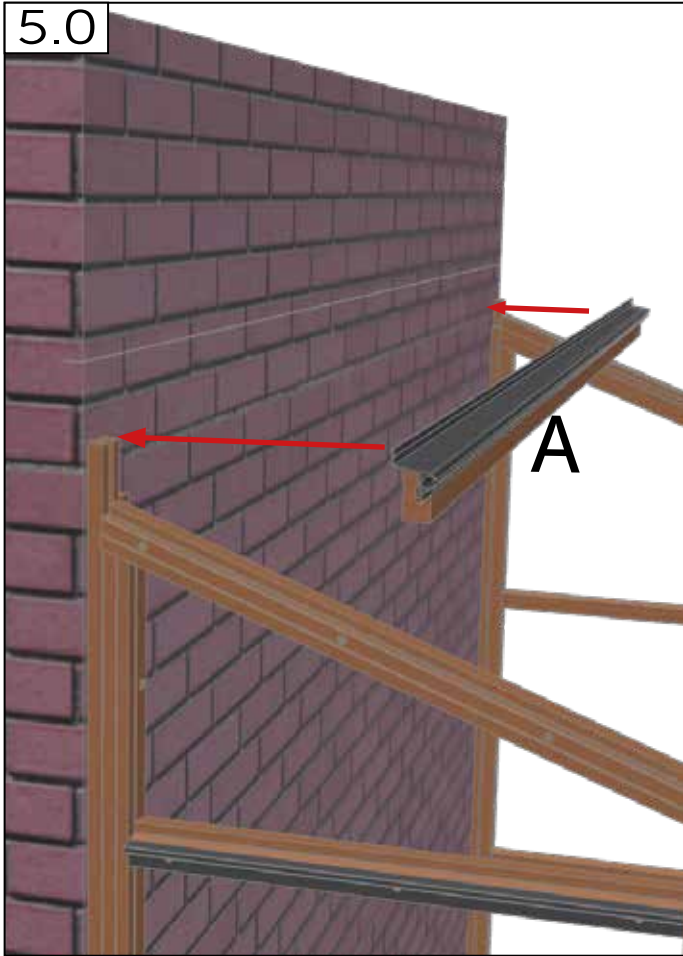

	#	mm
	-	-
	SC125	4.2 x 25
	SC058	4.8 x 100
	WA501	-
	FX200	-







	#	mm
	A	-
	B	-
	C	-
	SC058	4.8 x 100
	WA501	-
	FX200	-
	AD001	-

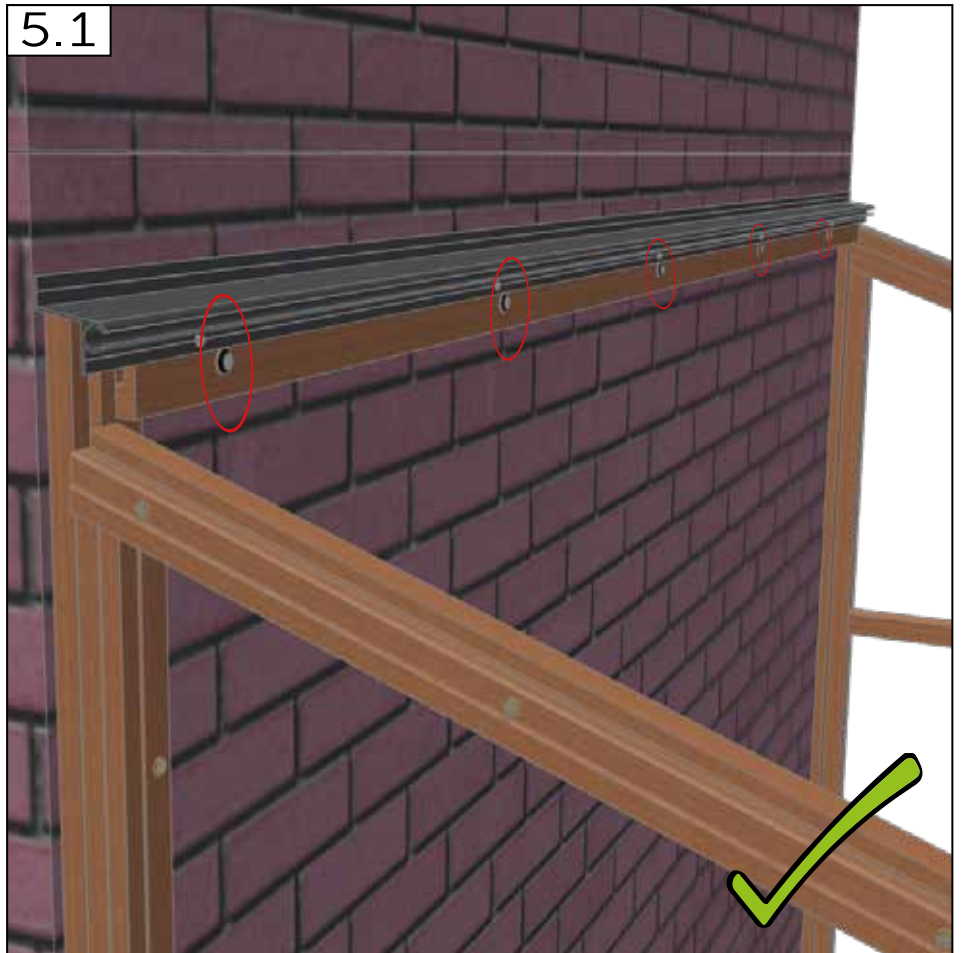

Assemble (Extension Length Only) - Assembler - Montera - Montieren  
- Montere - Armar - Samle

5.0

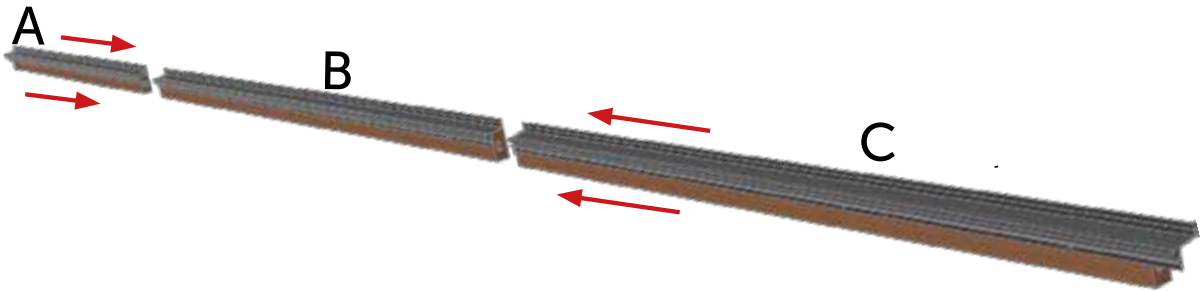

5.1

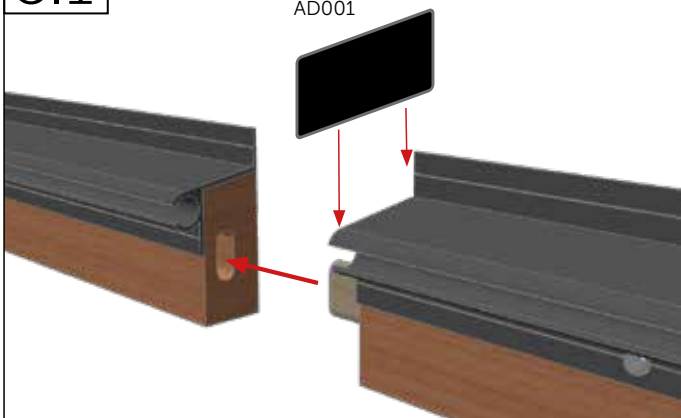

5.2

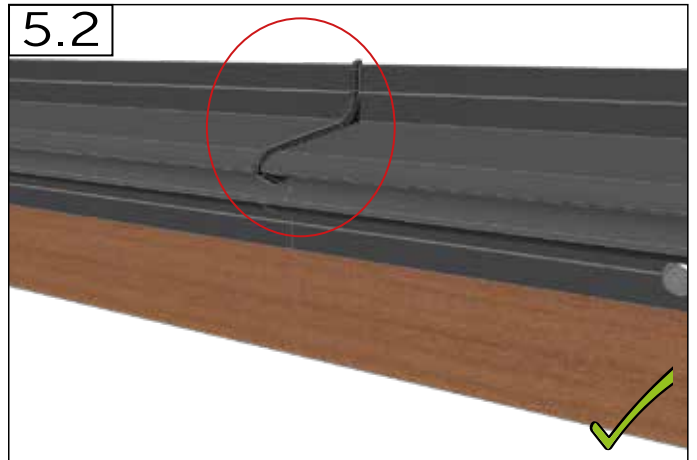

5.3

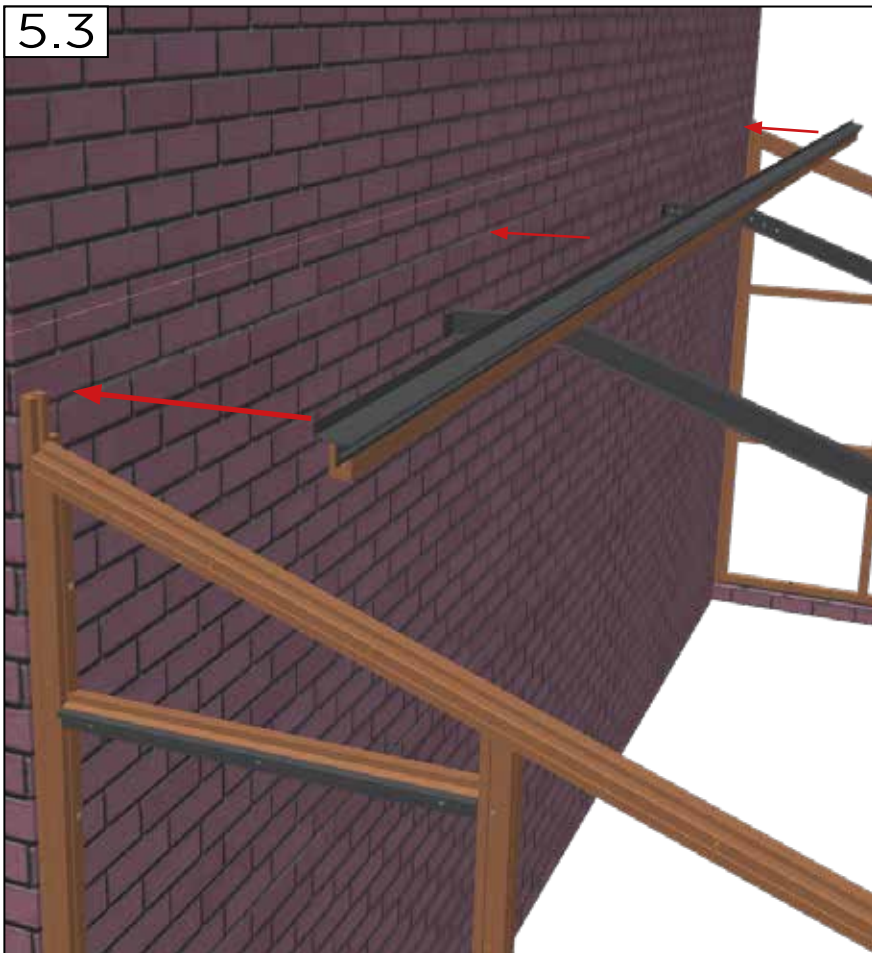

5.4

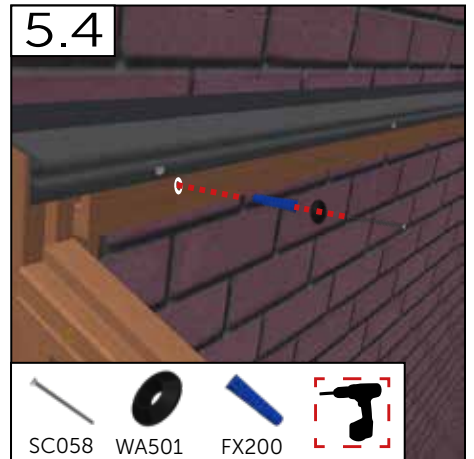

5.5



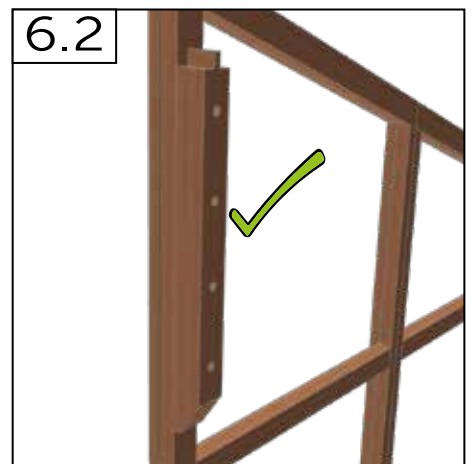
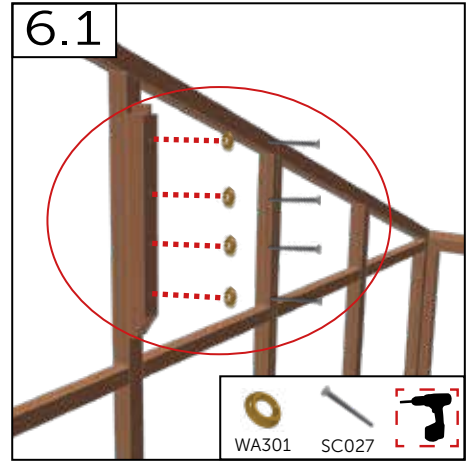
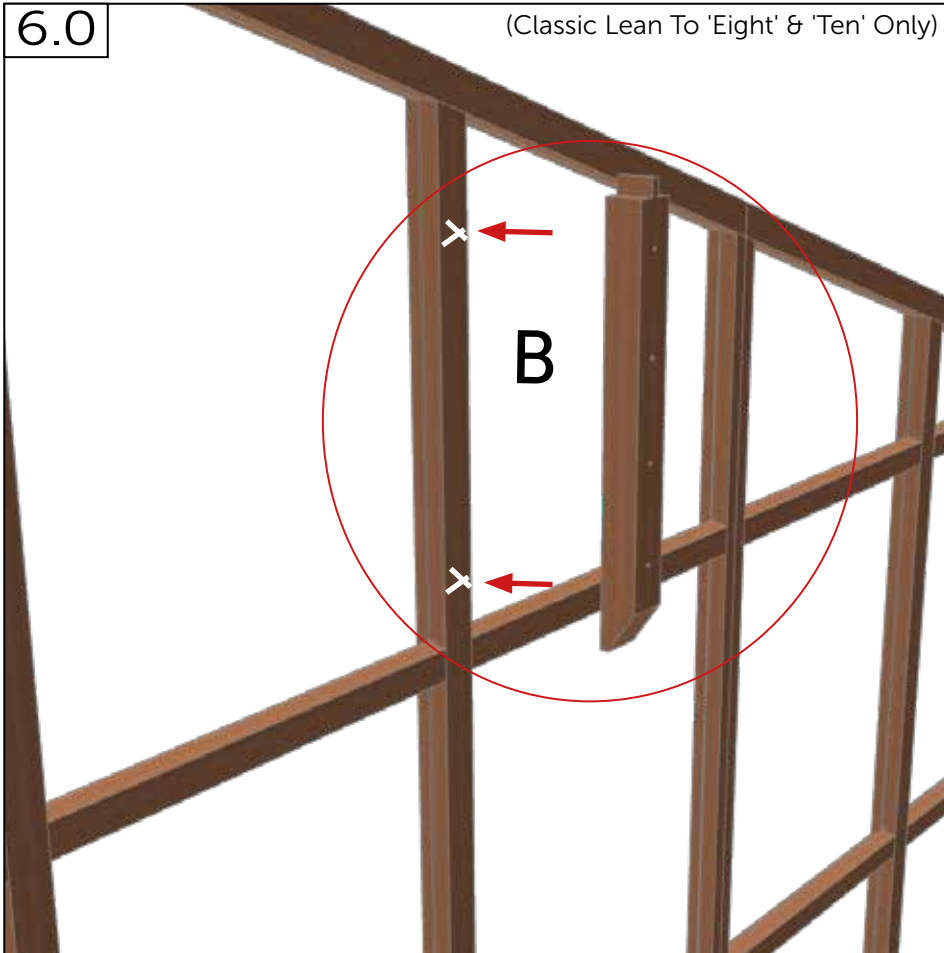

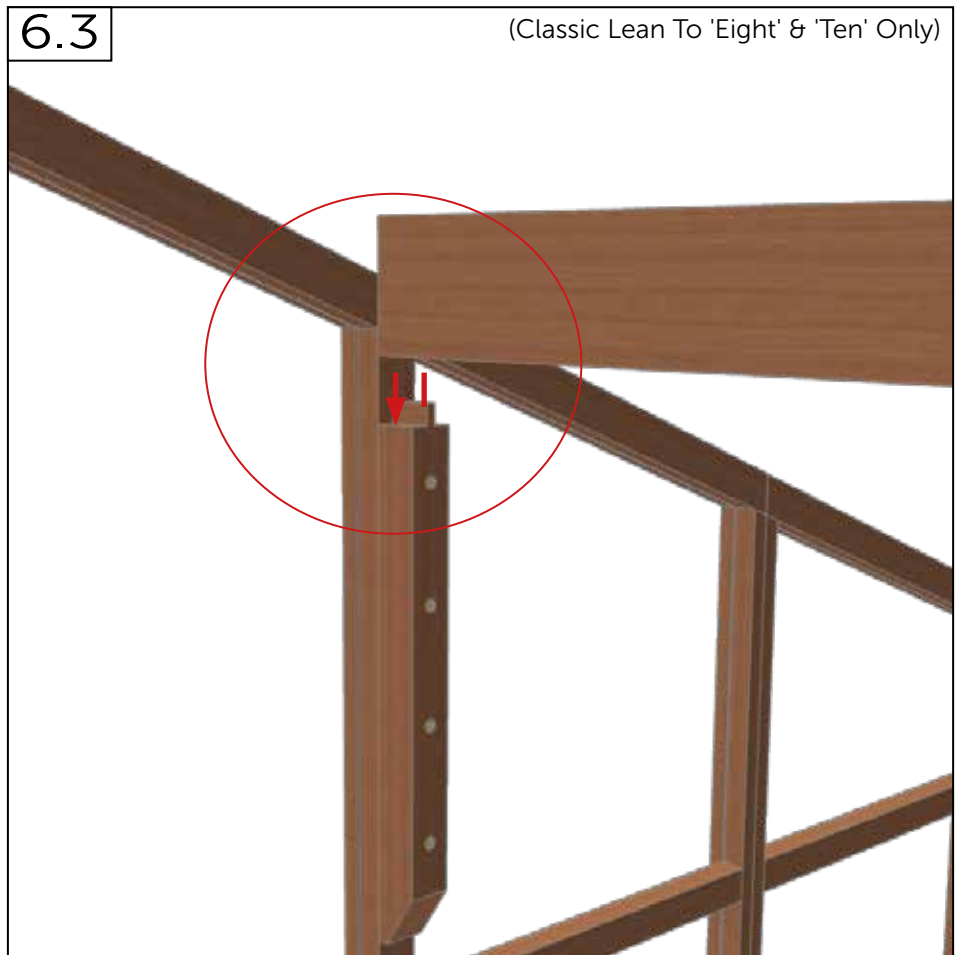

	#	mm
	B W475-300	300
	WA301	
	SC027	4.2 x 65
	A W092	-
	SC125	4.2 x 25



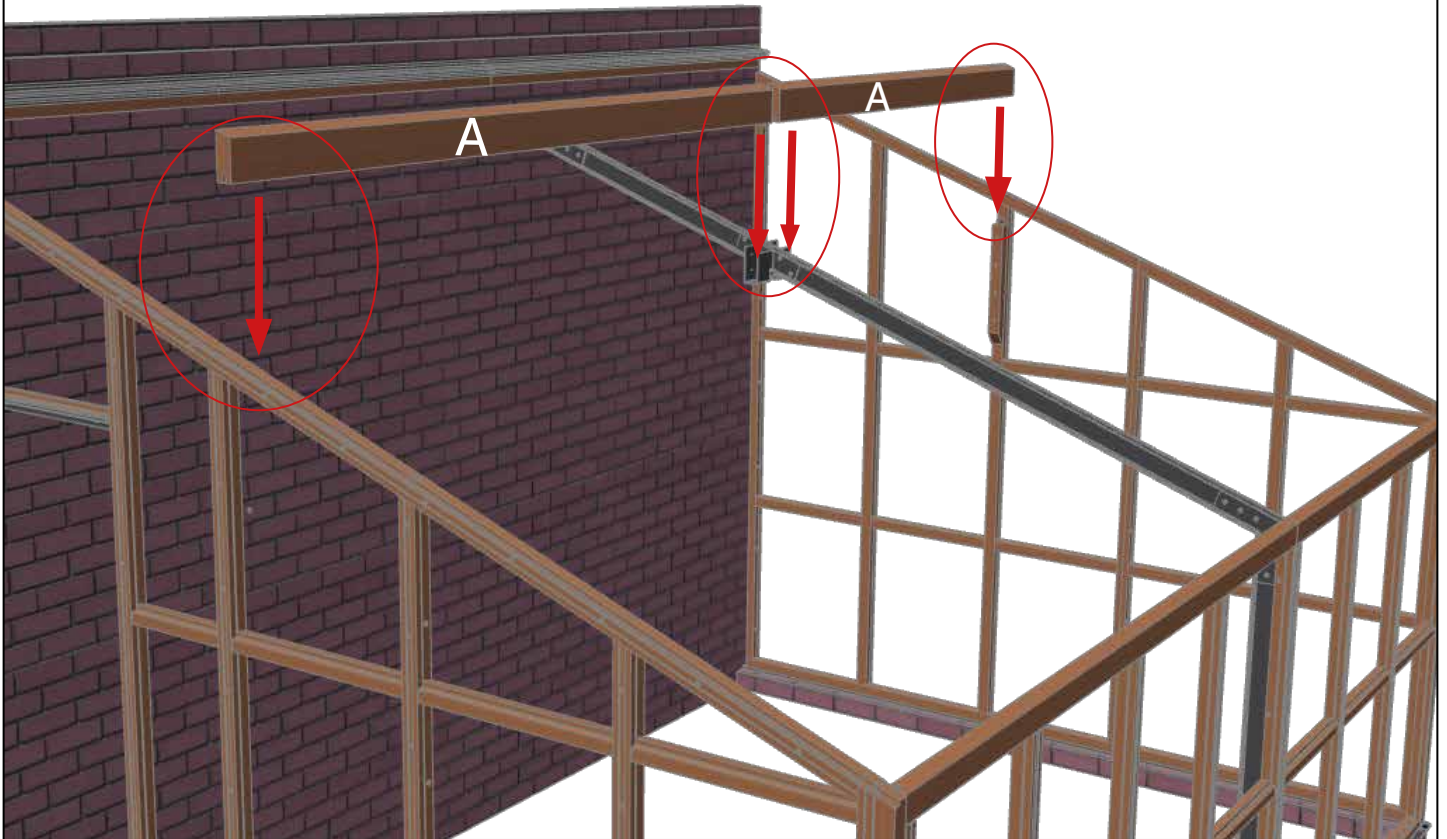

6.0



	#	mm
	A W093	-
	SC125	4.2 x 25

6.1



6.1

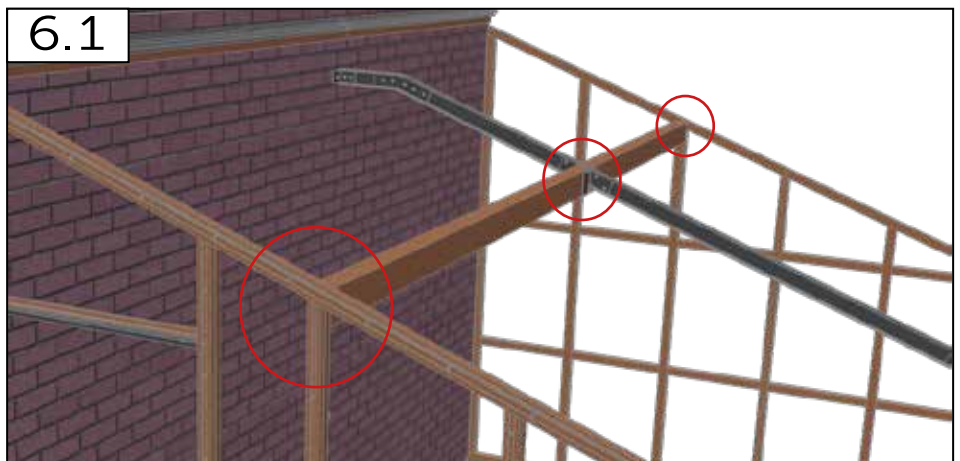

Roof Panels - Panneaux de toit - Takpaneler - Dachplatten  
 - Takpaneler - Paneles de techo - Tagplader

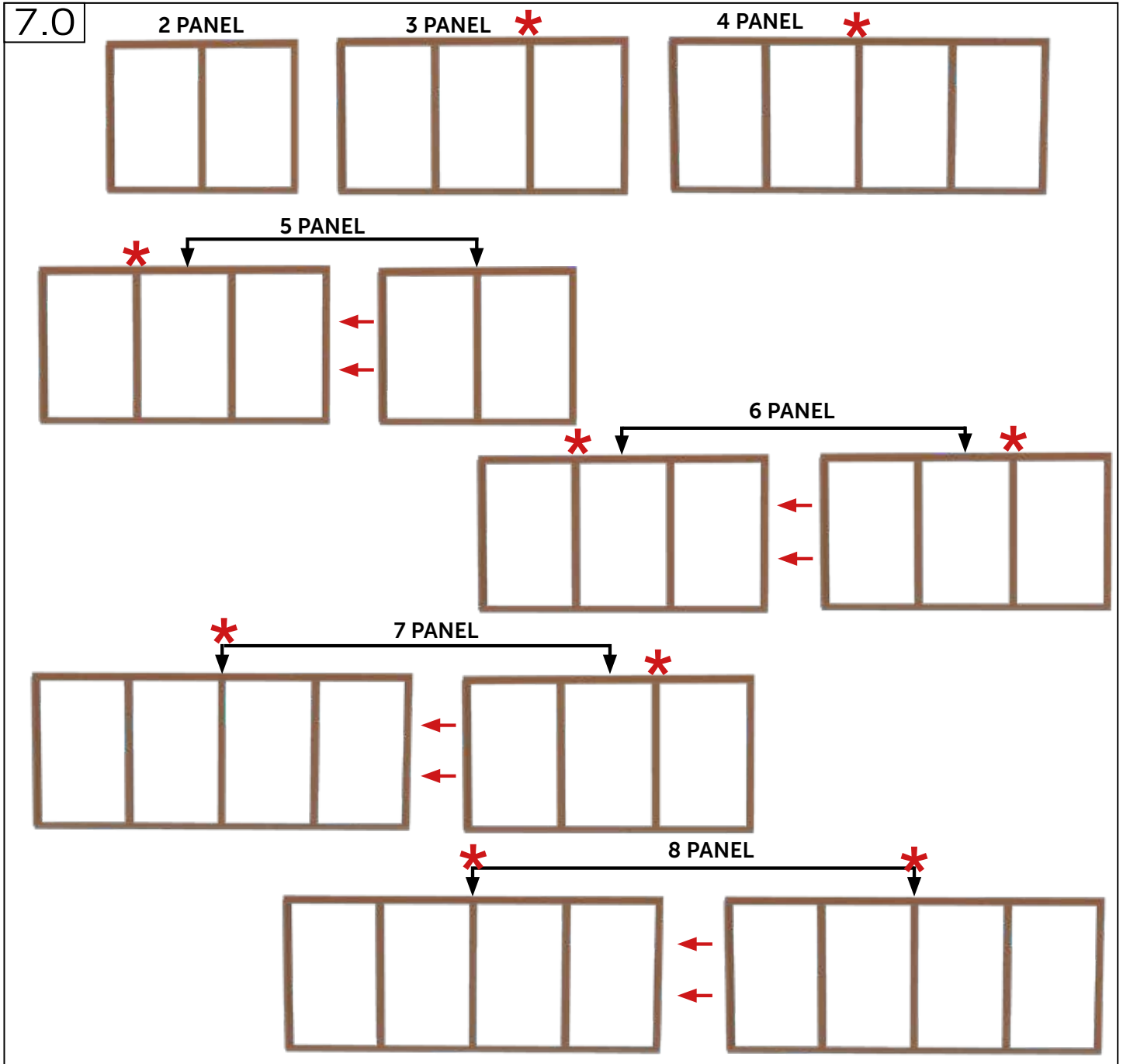

	#	mm
	SC027	4.2 x 65
	WA301	No. 8
	W010	-
	W055	-
	W475-305	-
	SC026	4.2 x 50
	SC057	4.2 x 80

8.7

WA301 SC057 SC026 W475-305



Roof Panels - Panneaux de toit - Takpaneler - Dachplatten  
 - Takpaneler - Paneles de techo - Tagplader

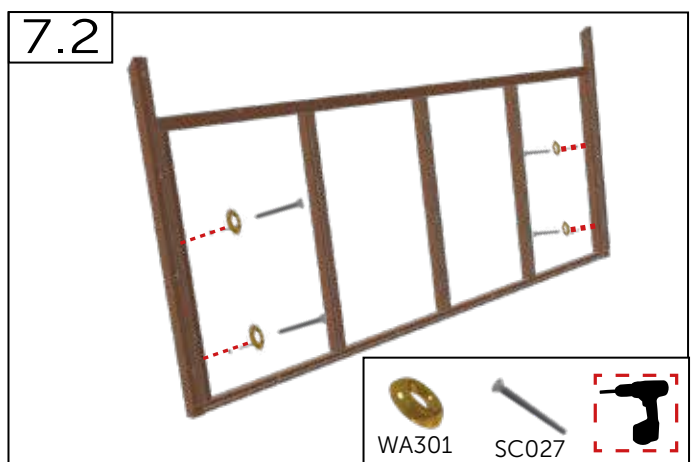
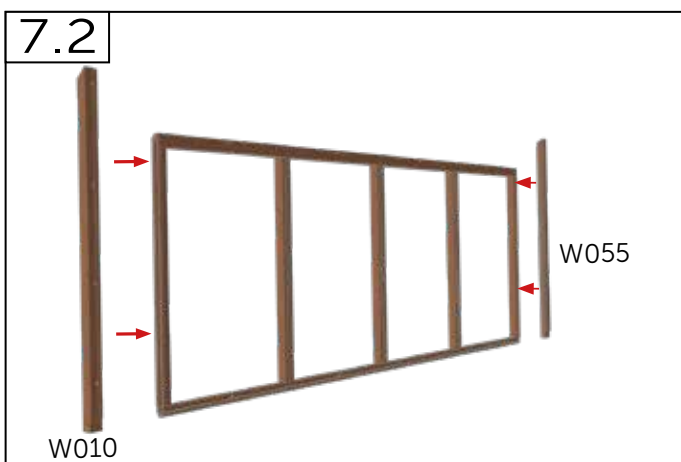
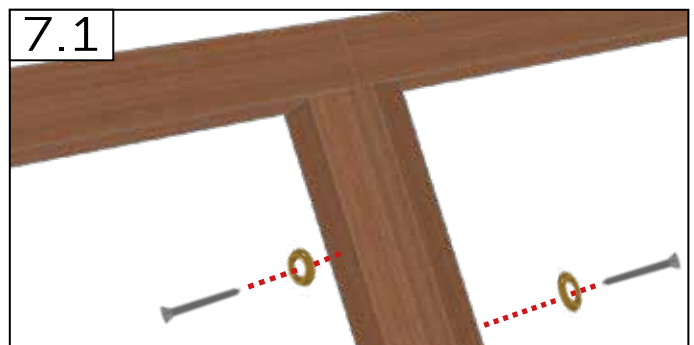
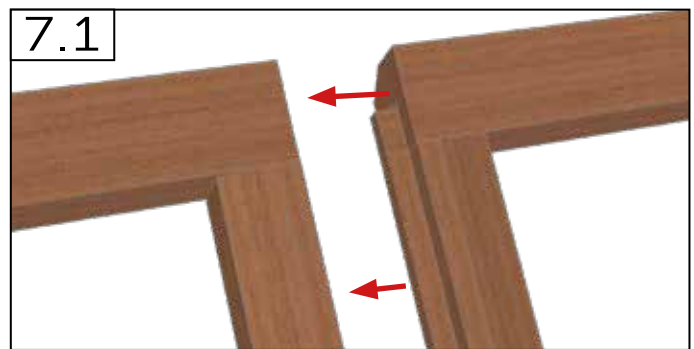
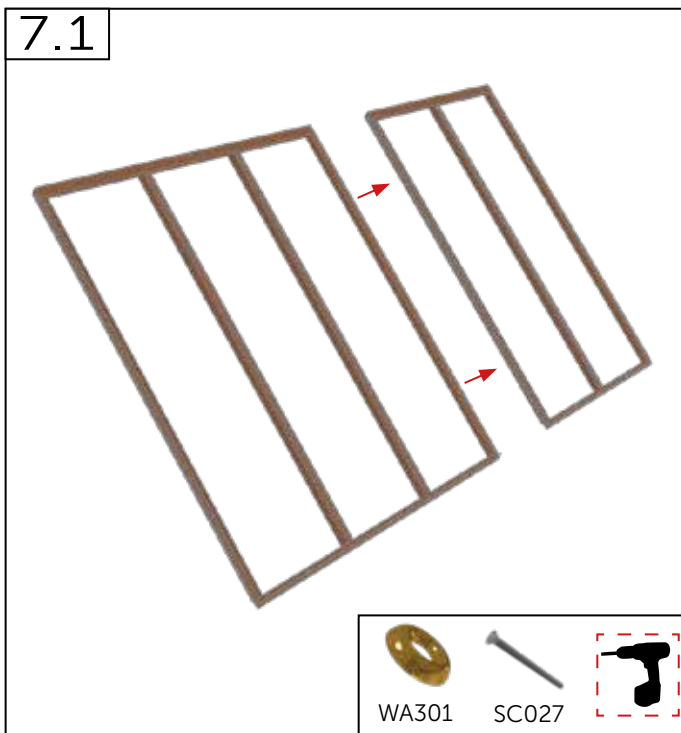
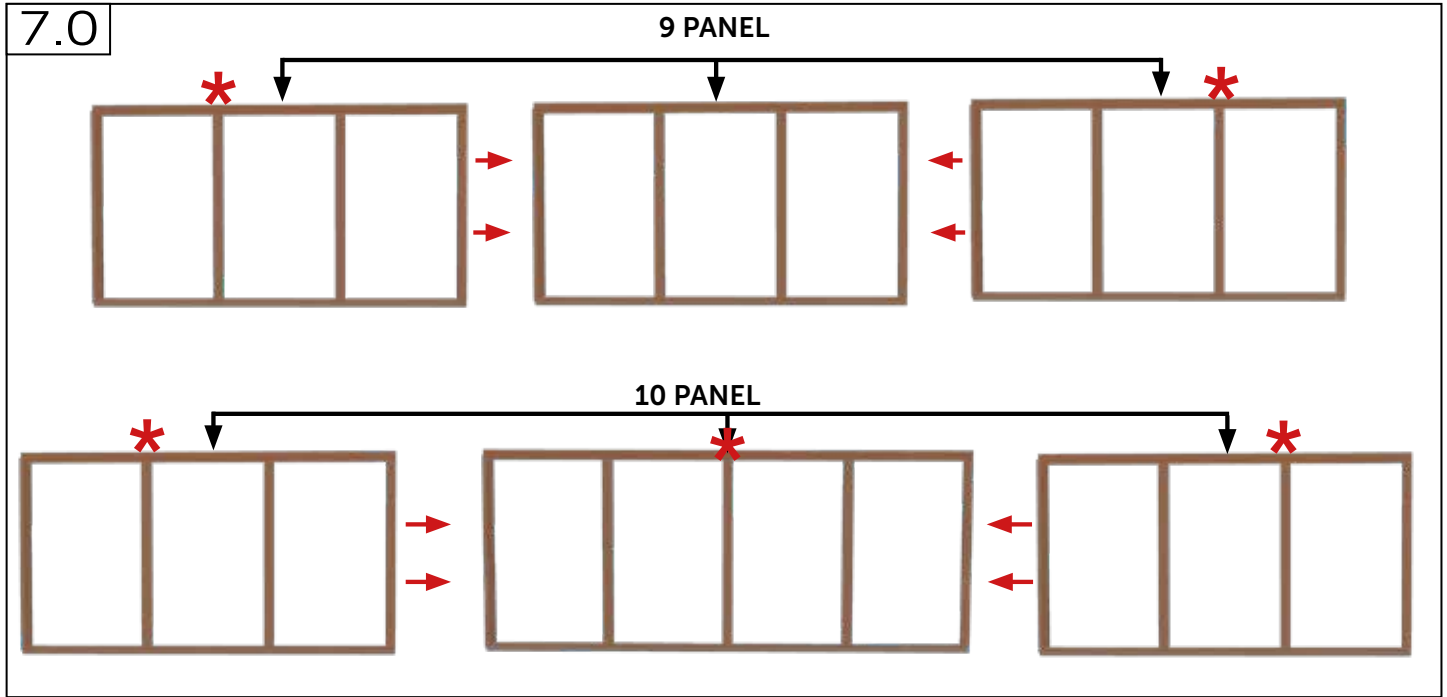

8.0

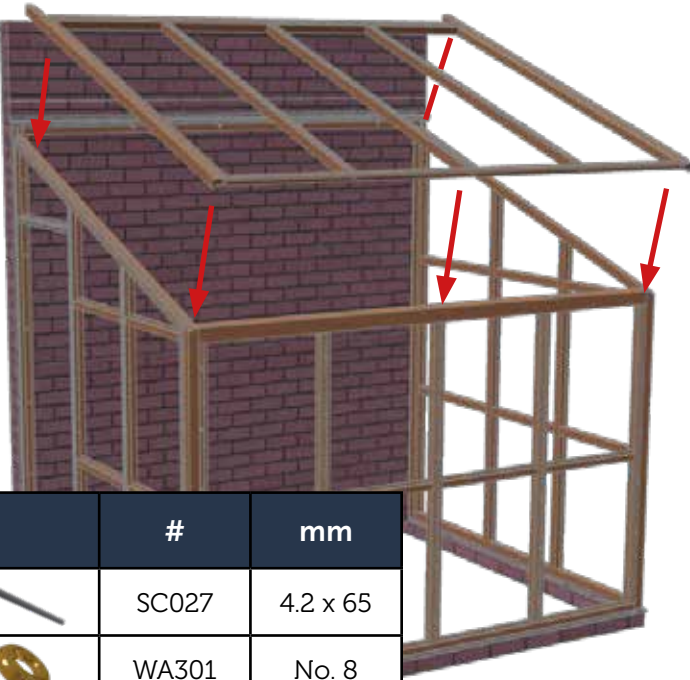

	#	mm
	SC027	4.2 x 65
	WA301	No. 8
	SC125	4.2 x 25
	SC026	4.2 x 50

8.1



8.2

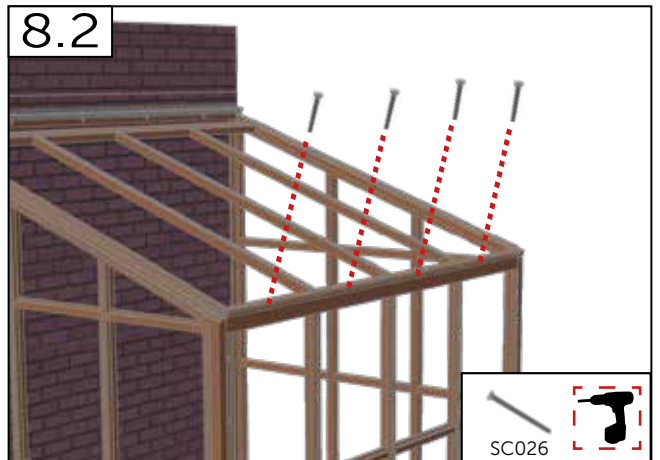

8.3

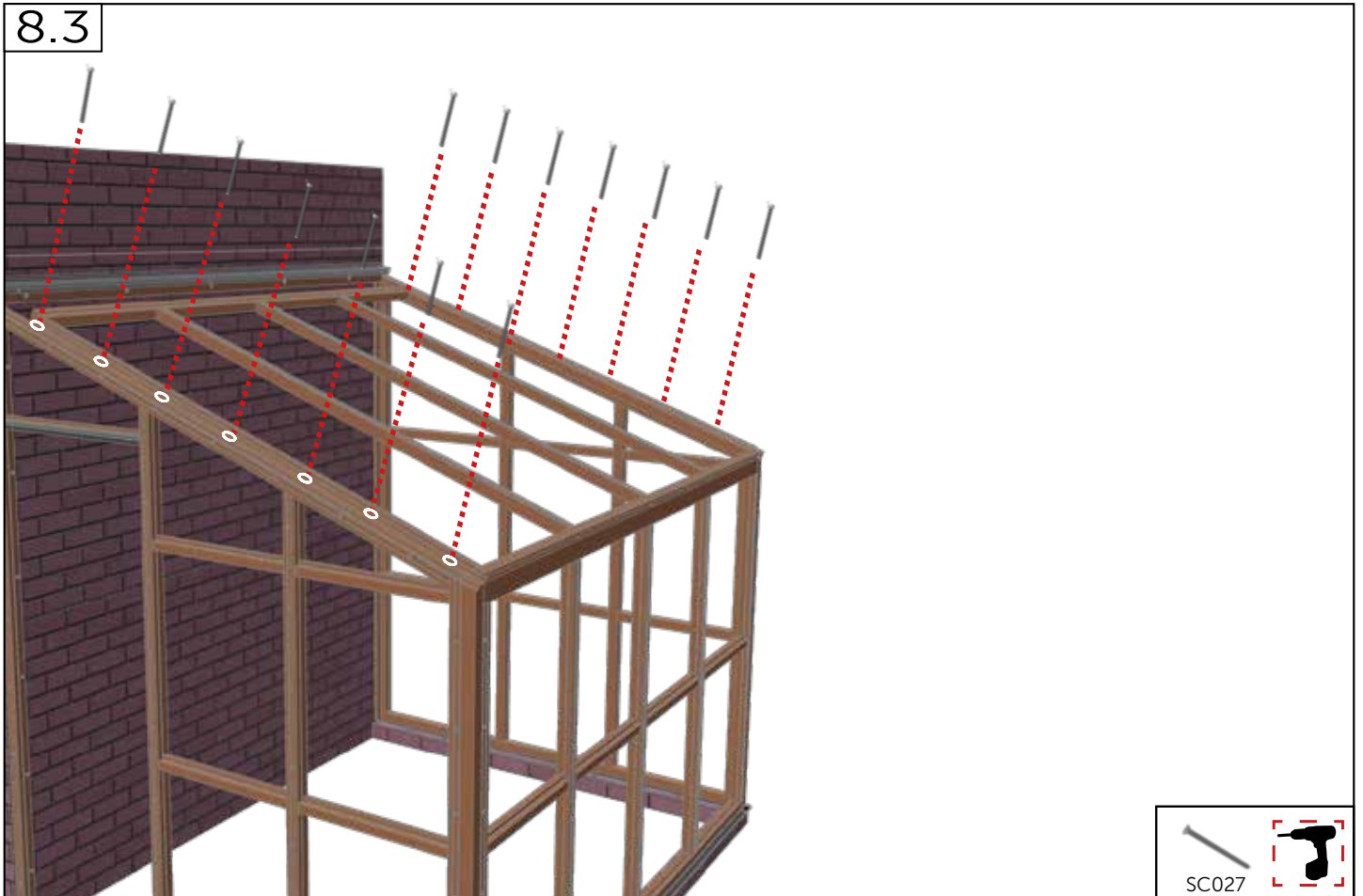

# Roof (Extension Length Only) - Toit - Tak - Dach - Tak - Techo - Tag

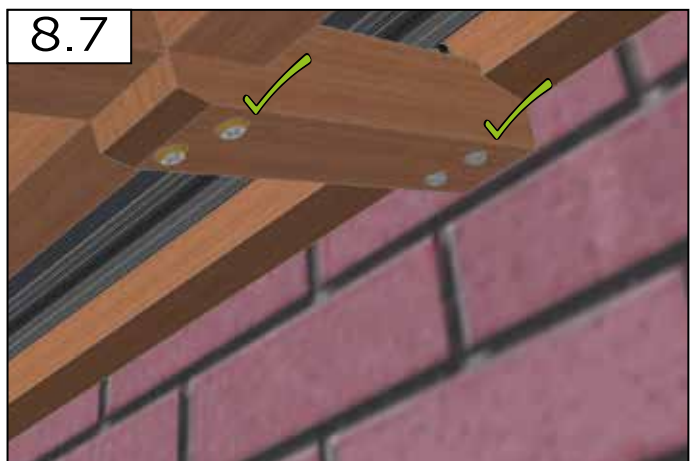
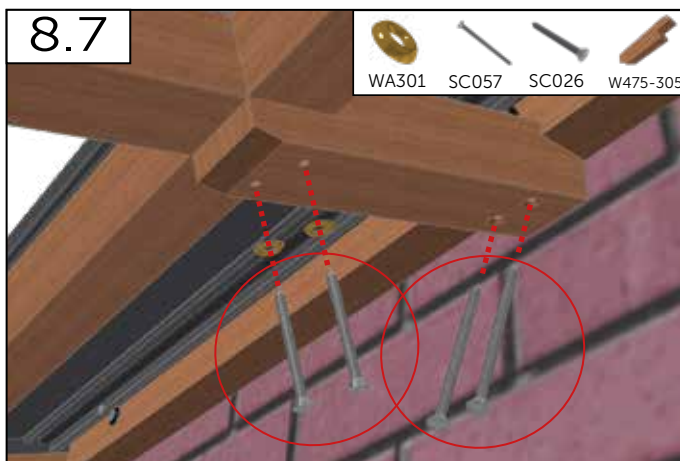
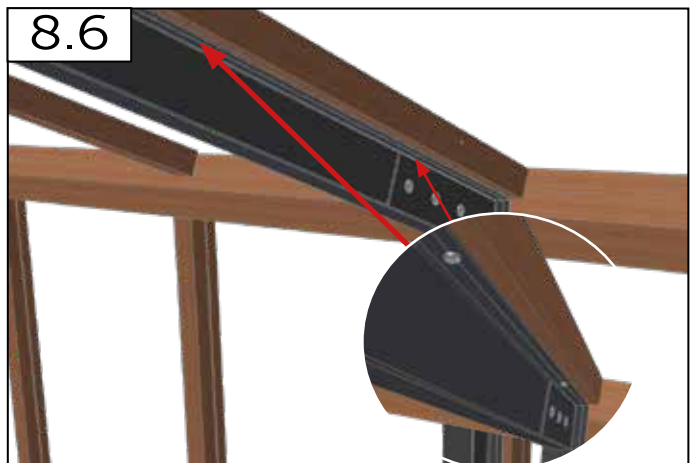
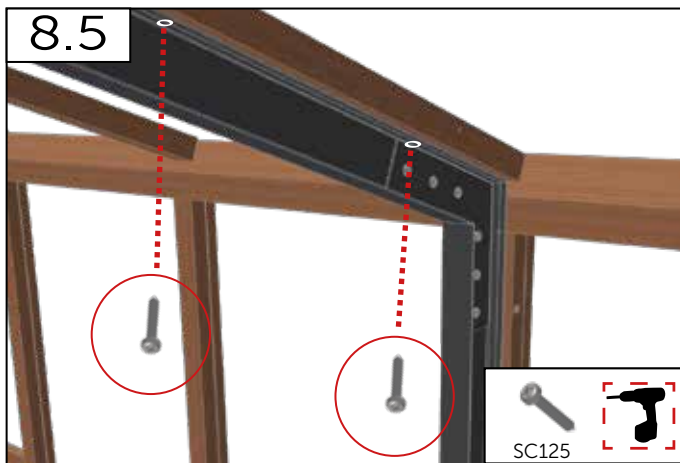
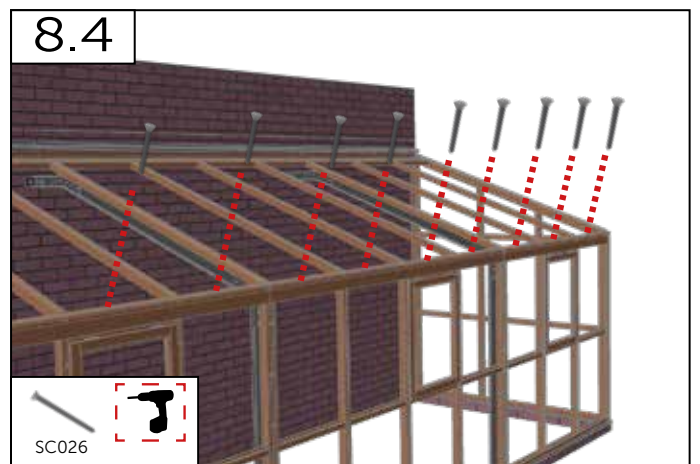
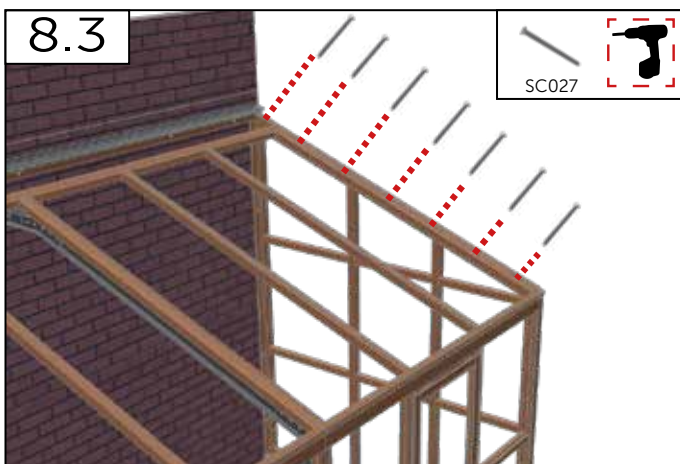
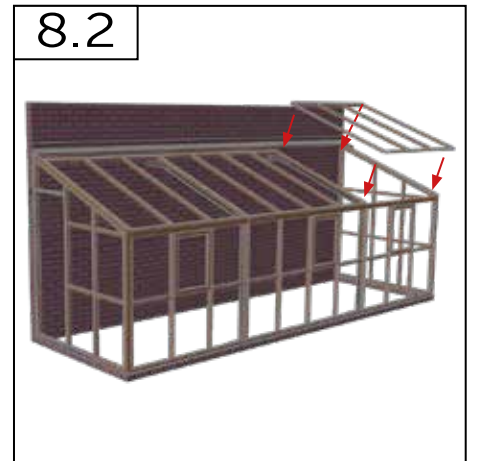
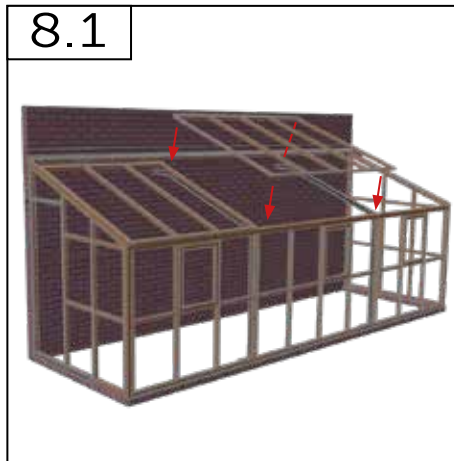
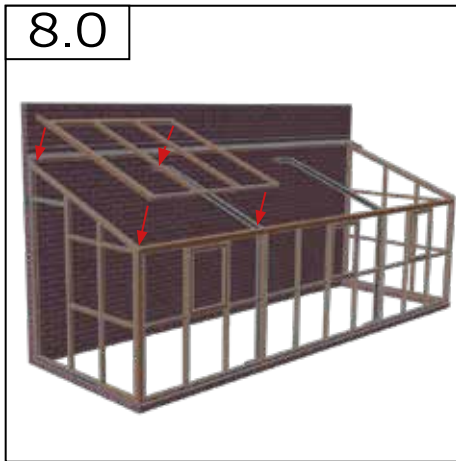



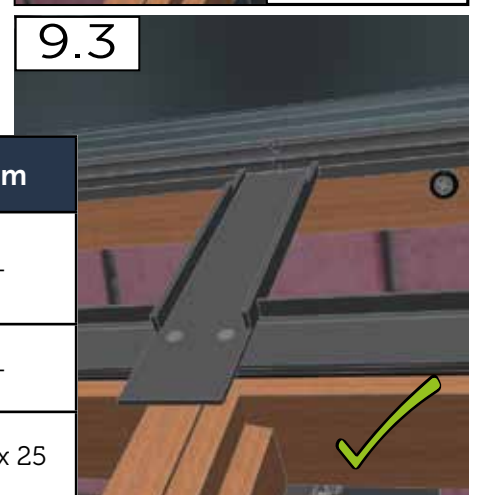
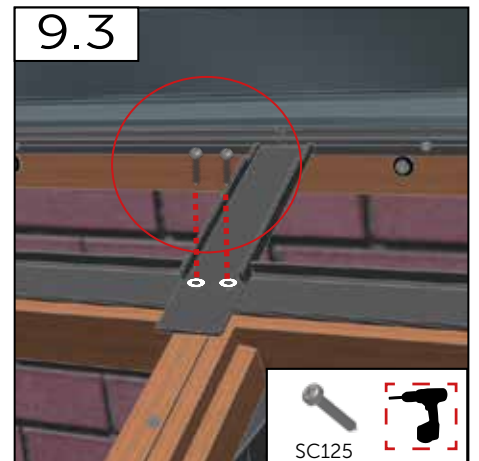
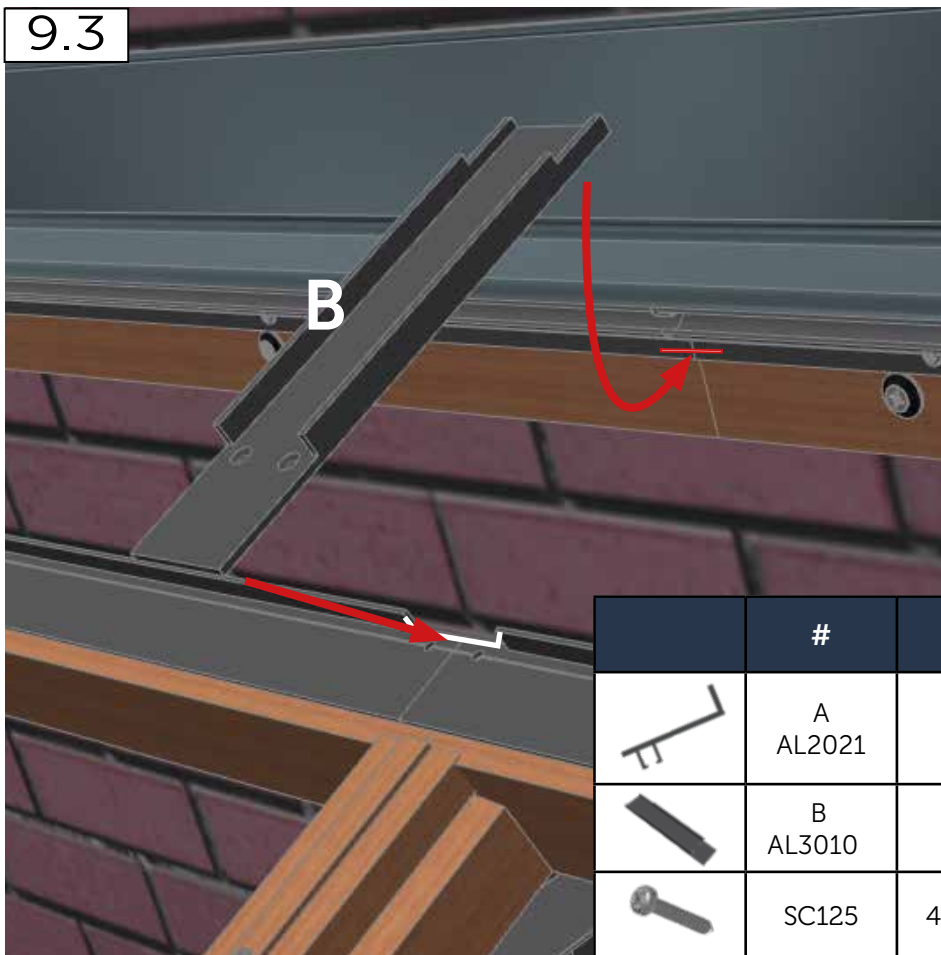
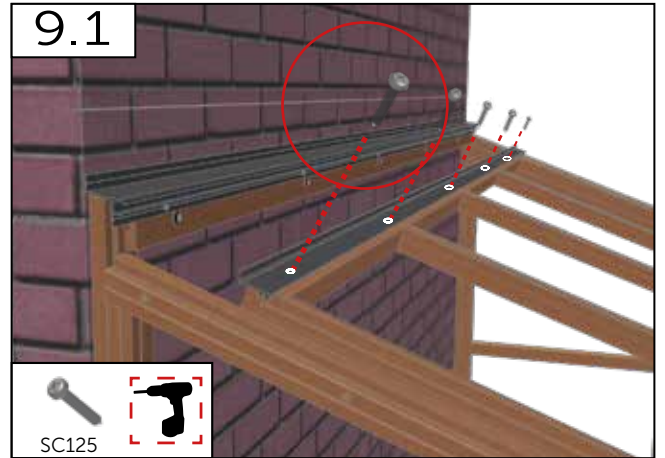
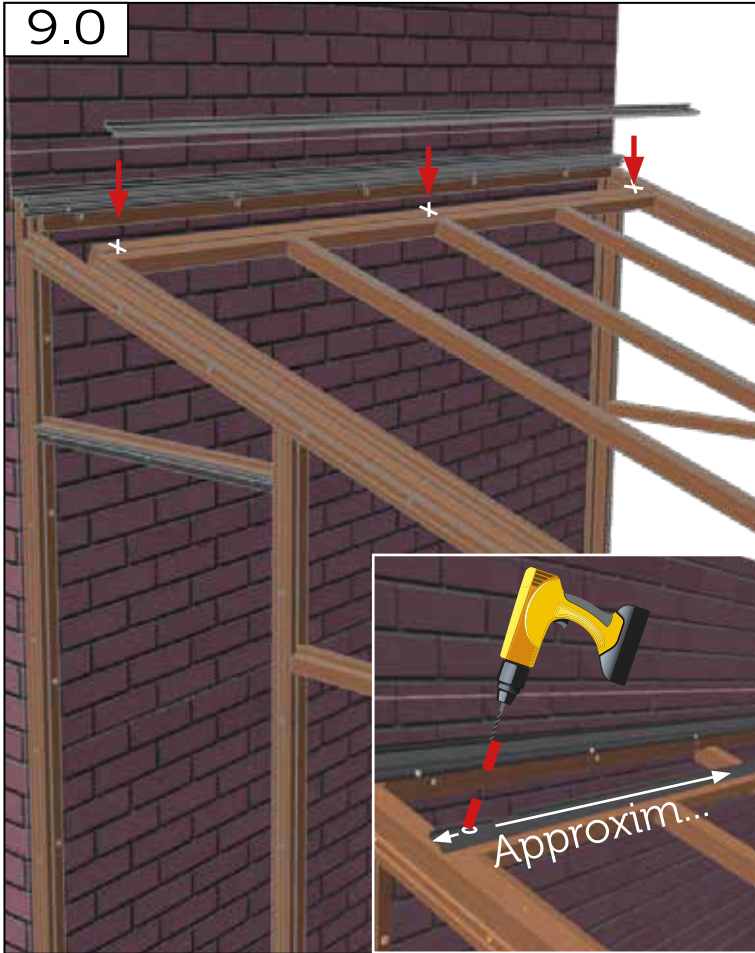

# Trims (Extension Length Only) - Garnitures - Trims - Schnitte - Trimmer - Adornos

	#	mm
	B AL2000	-
	AV001	-
	WA500	M6 x 16
	NU101	M6
	BL122	M6 x 16

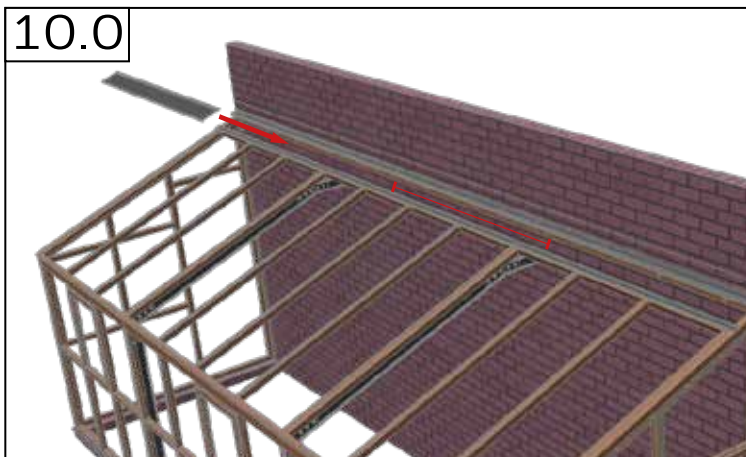
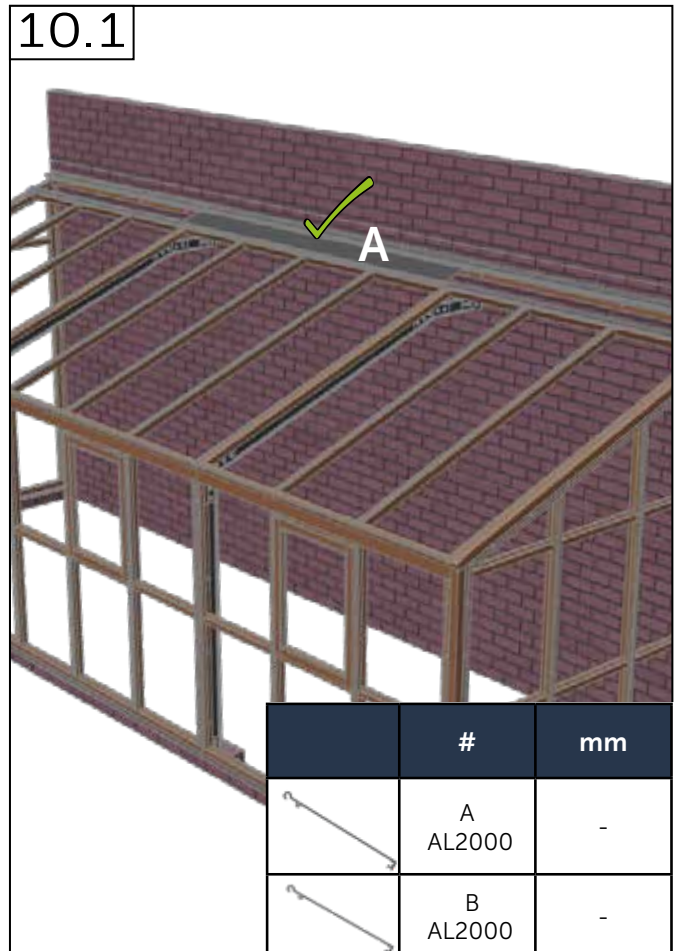
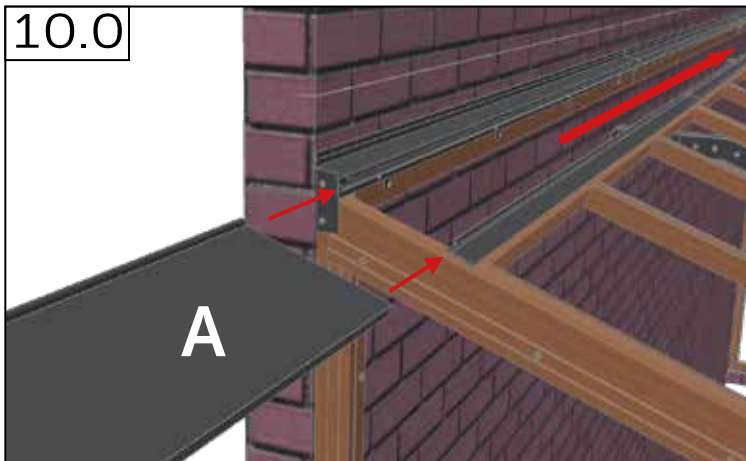
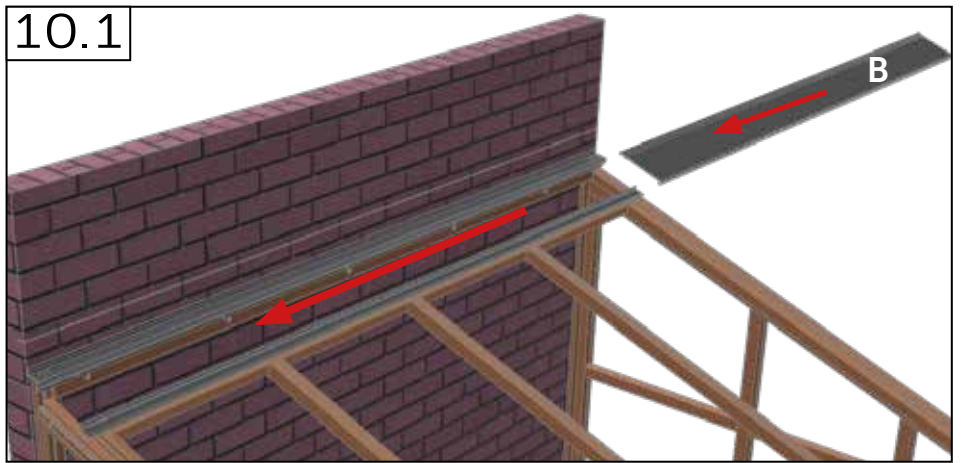
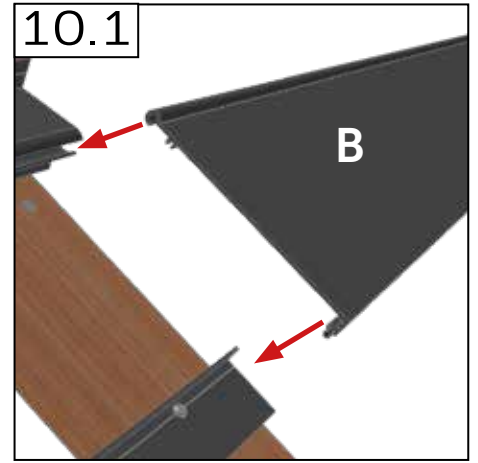
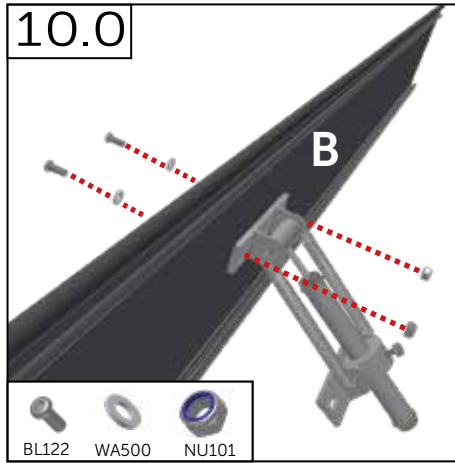



10.2

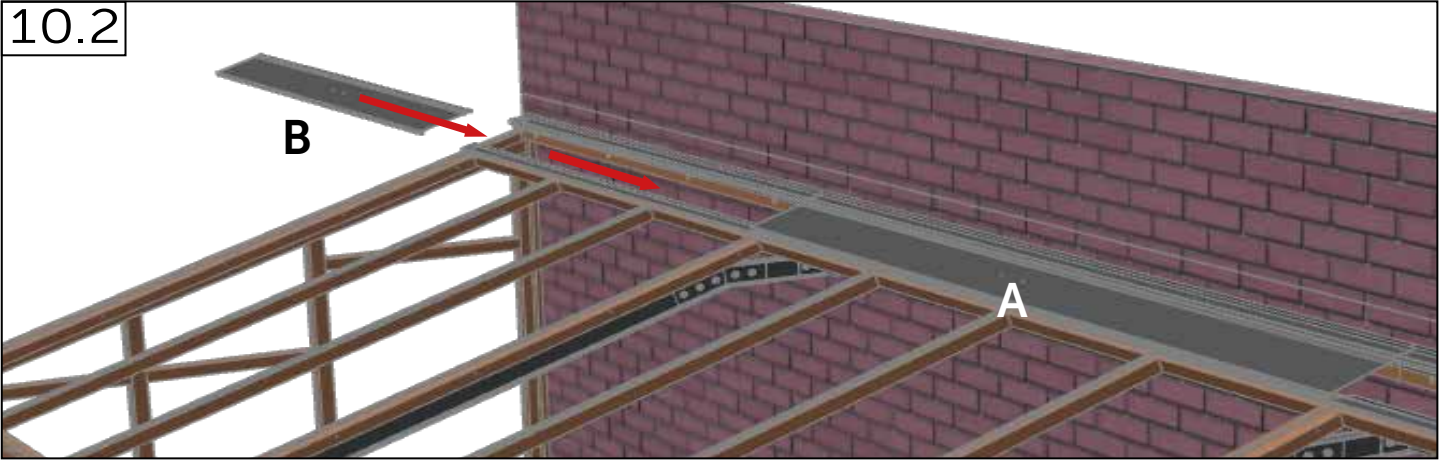

10.3

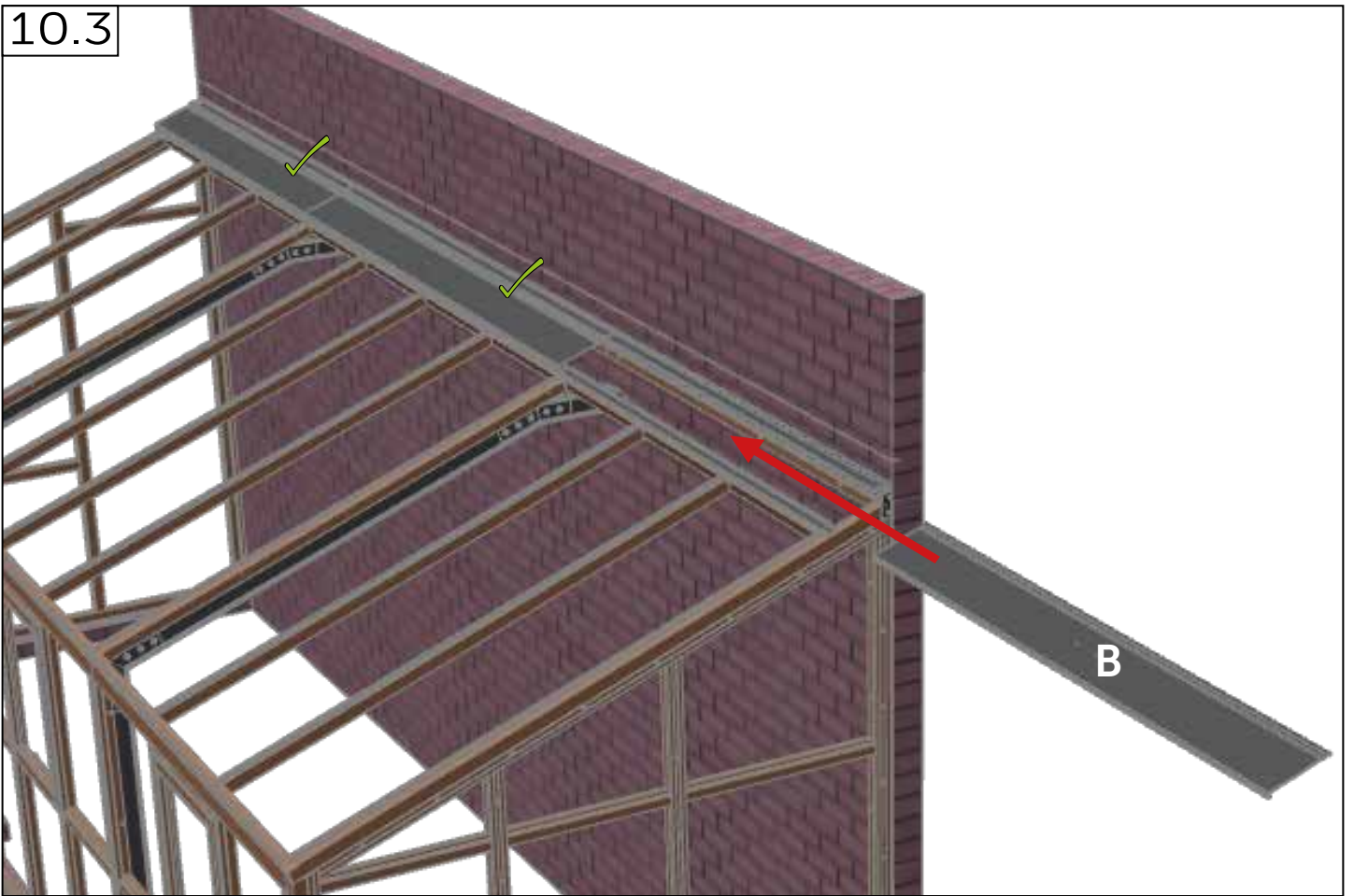

10.4

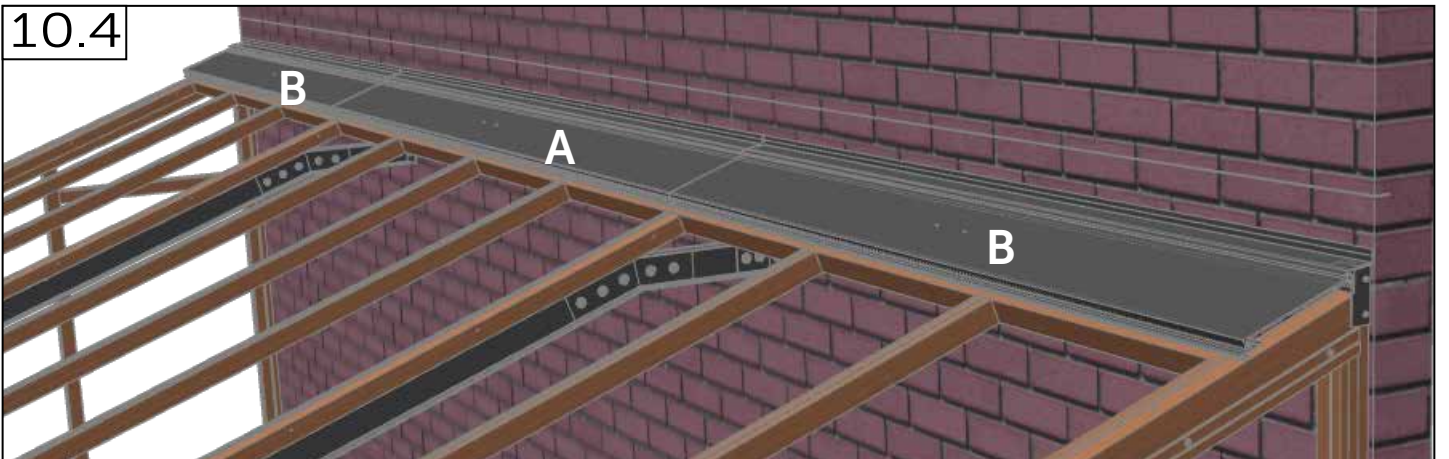

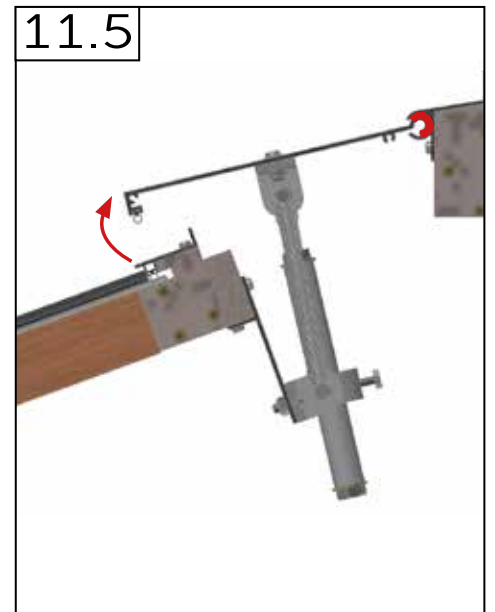
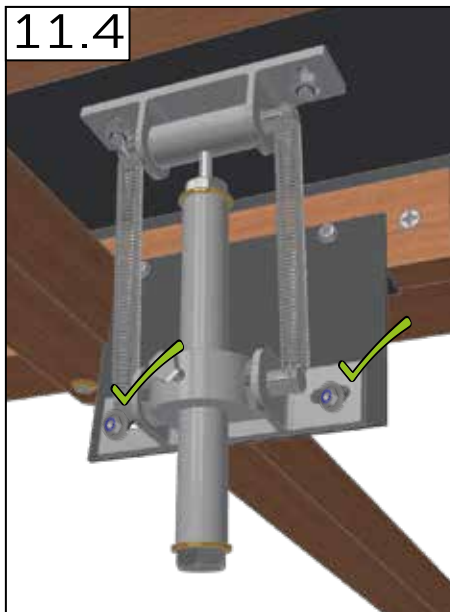
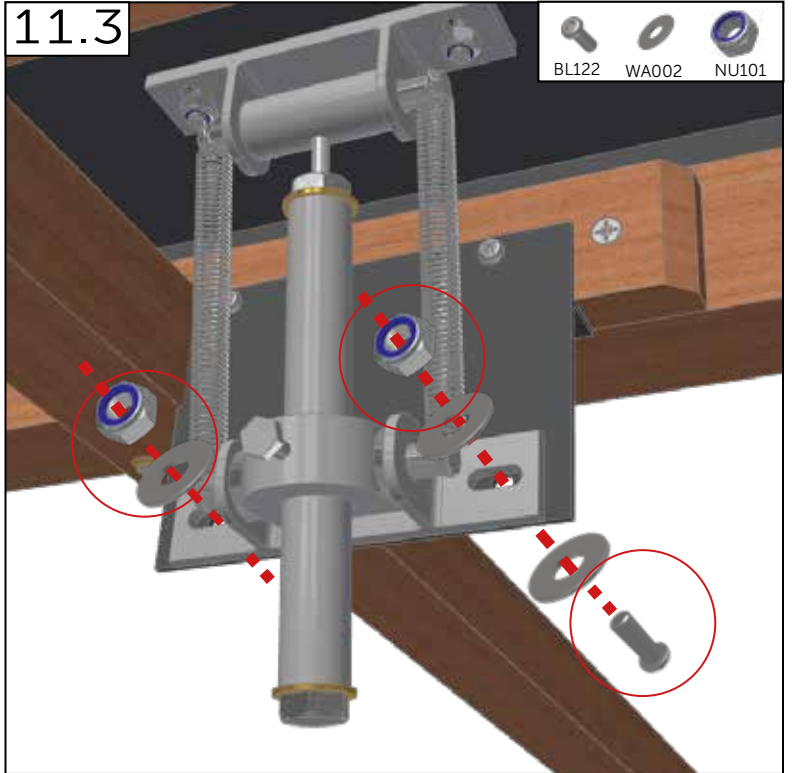
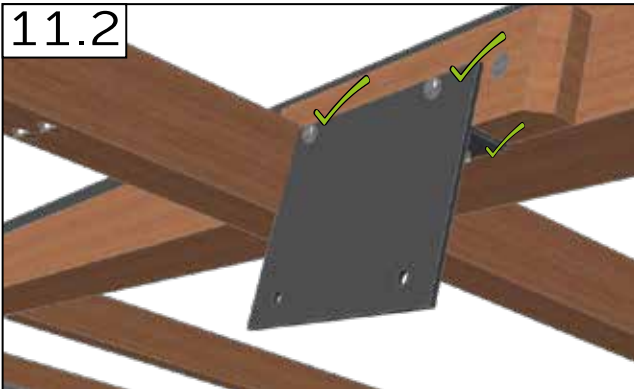
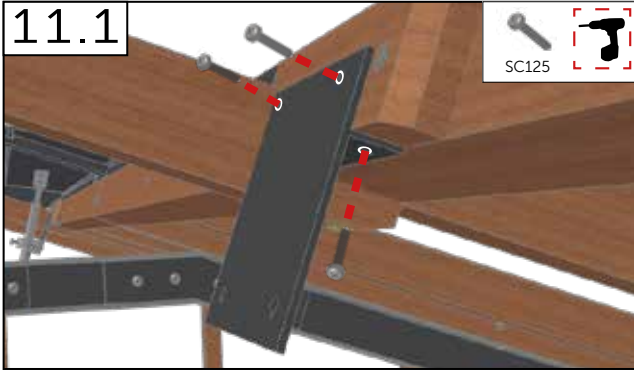



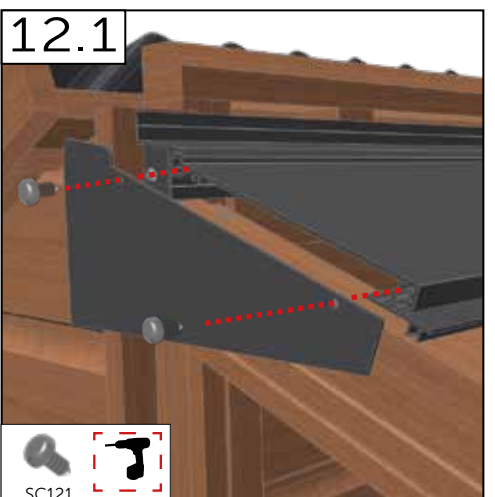
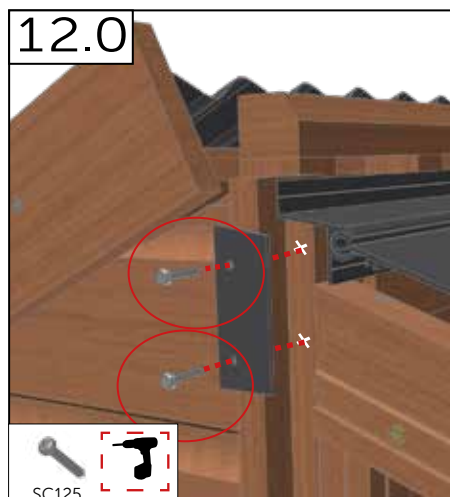



	#	mm
	AV001	-
	SC121	4.2 x 9.5
	A AL3025	-
	W430-05	-
	AL2031 /0130	-
	SC024	4.2 x 38
	SC125	4.2 x 25
	BL122	M6 x 16
	NU101	M6
	WA002	M6

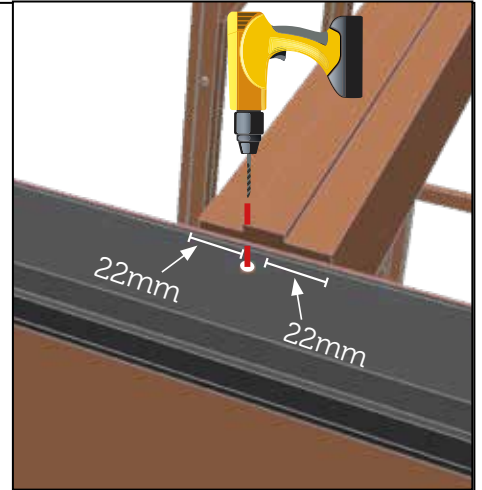
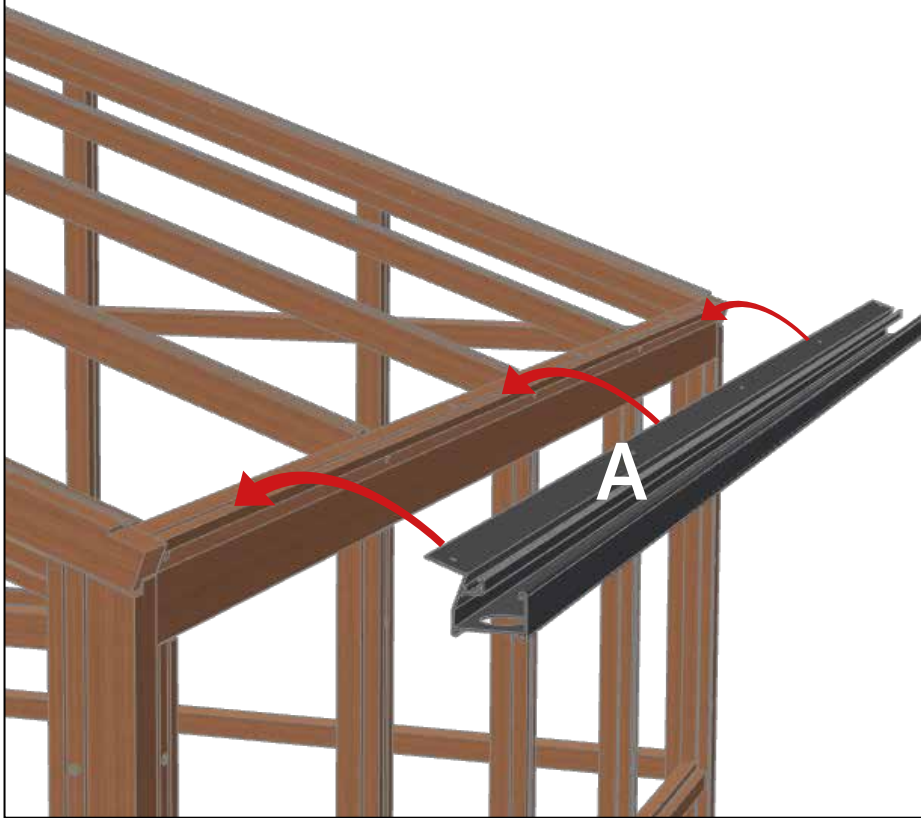



13.0



	#	mm
	A AL2008	-
	PT200	MALE FEMALE
	SC125	4.2 x 25
	SC121	4.2 x 9.5
	B AL3003	-

13.1

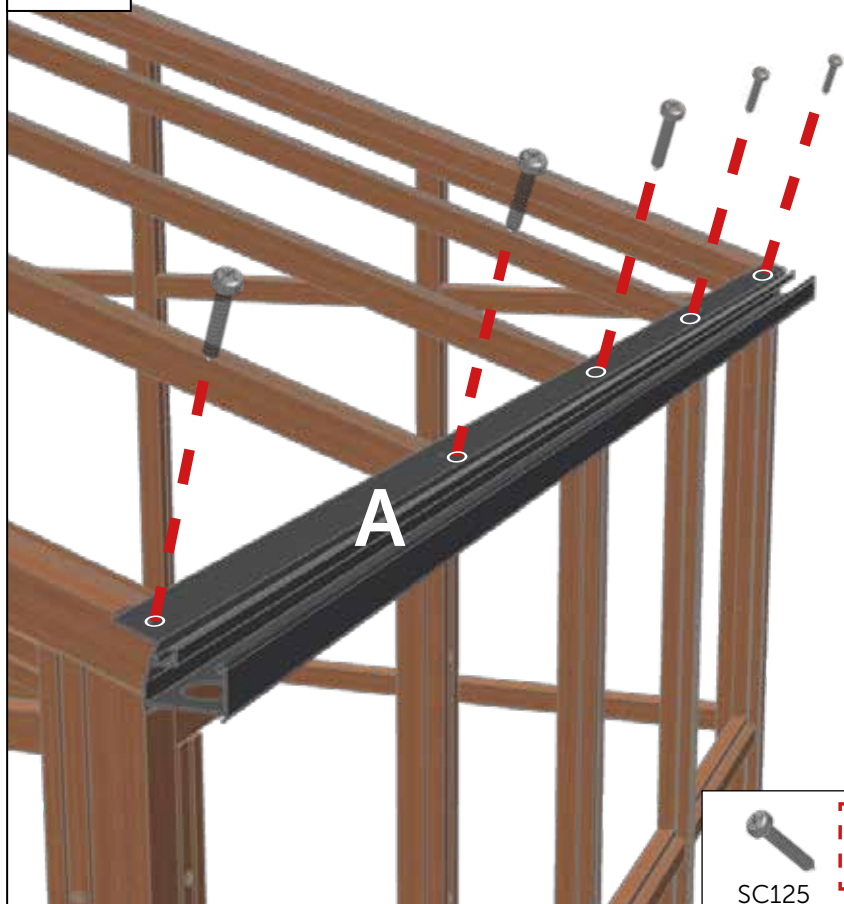

13.2

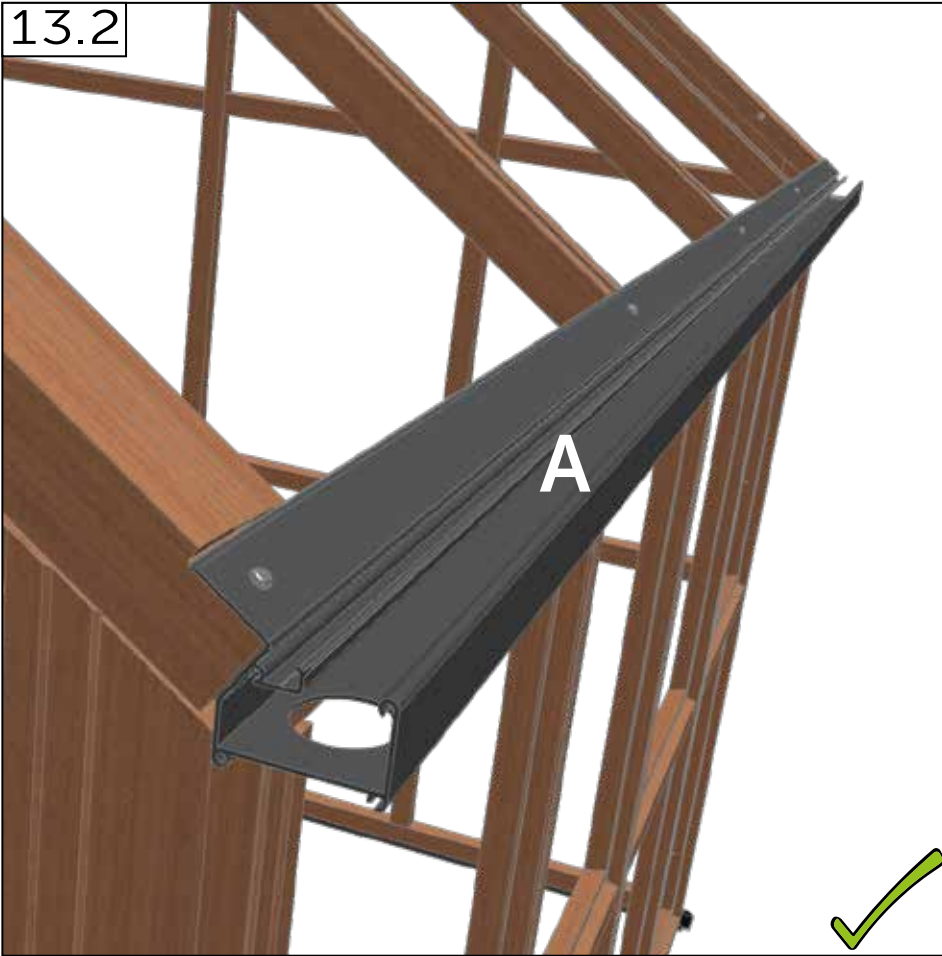

13.3

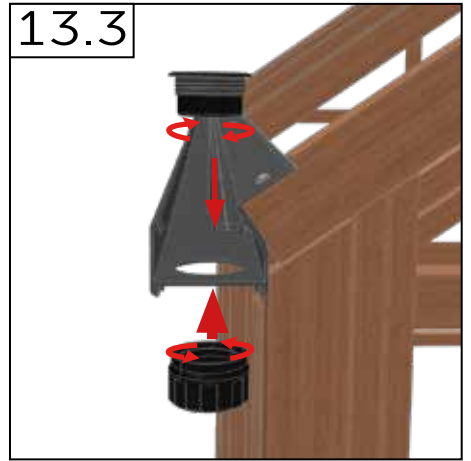

13.3



13.4

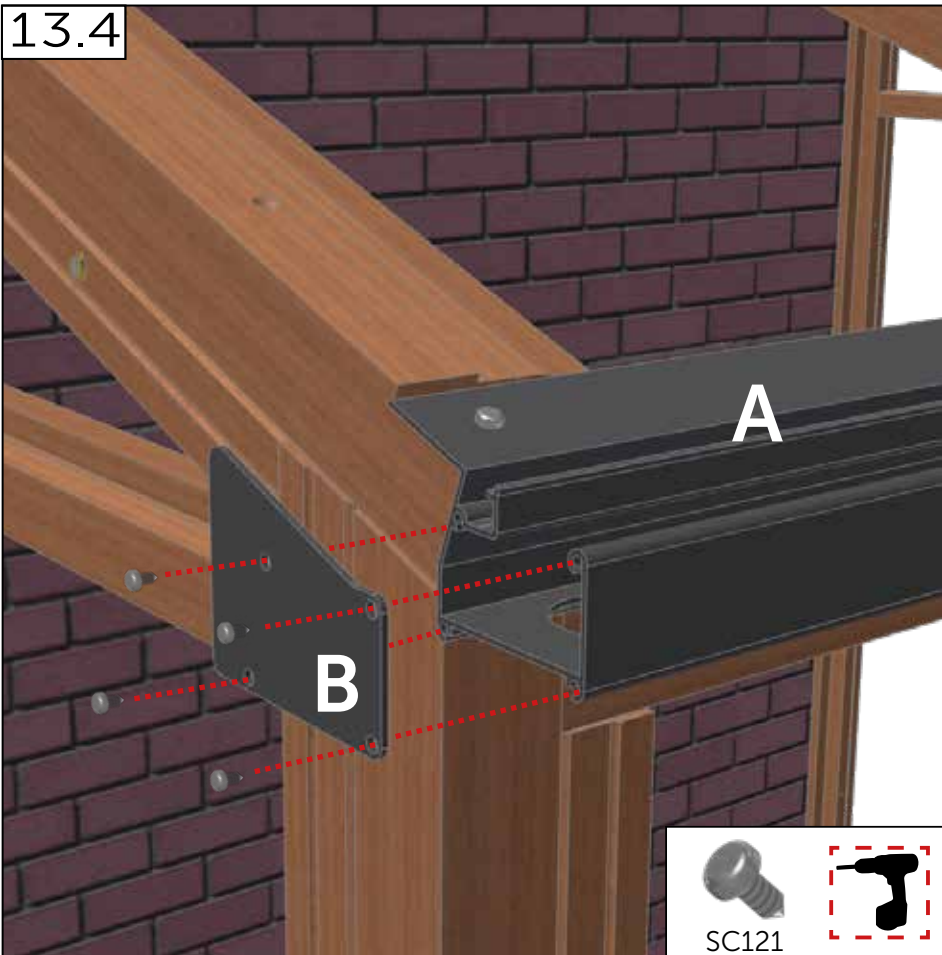

13.5

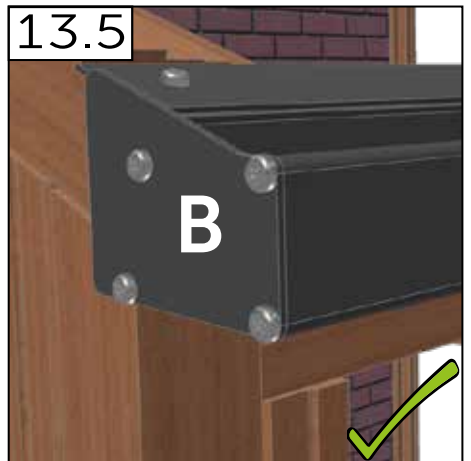

13.6





Trims (Extension Length Only) - Garnitures - Trims - Schnitte  
 - Trimmer - Adornos

13.0

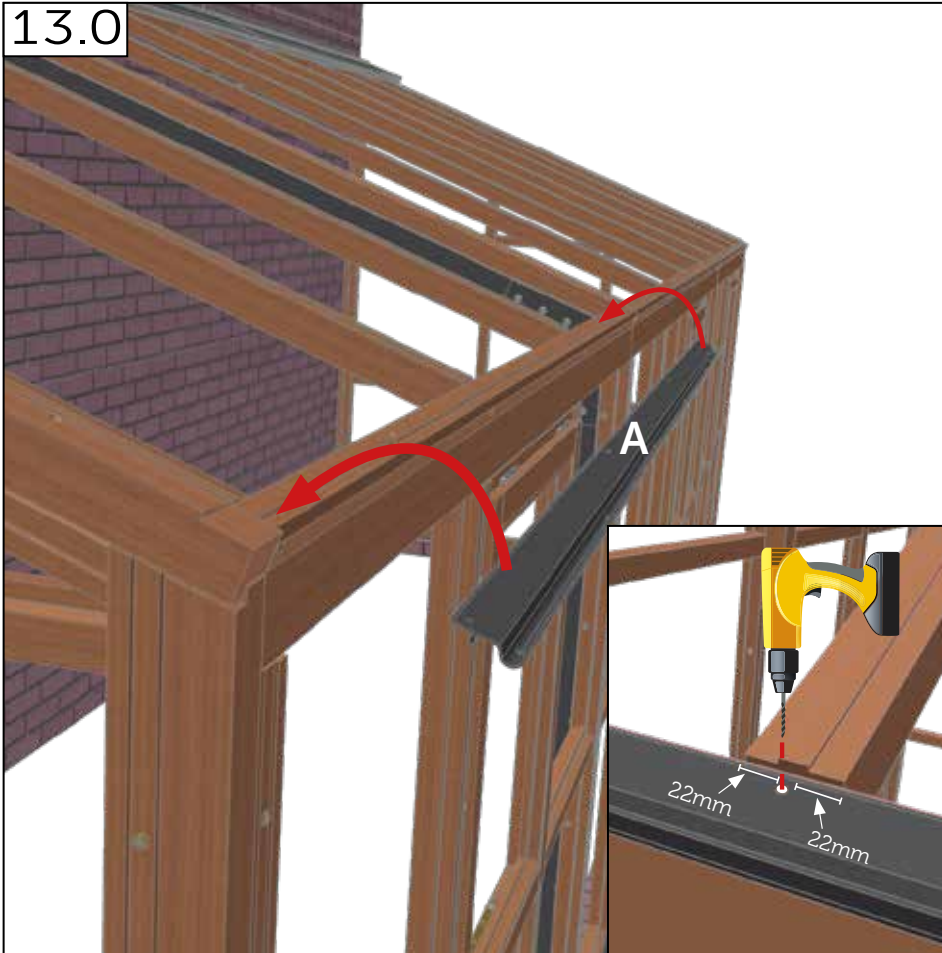

13.1

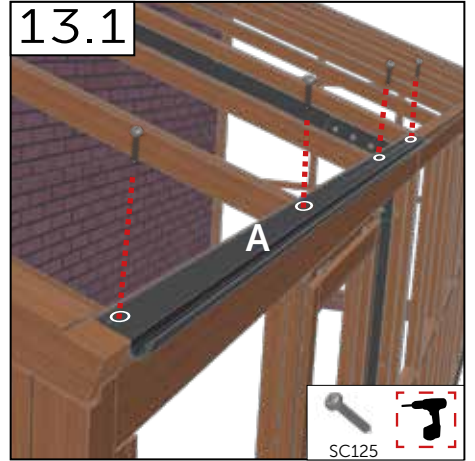

13.2

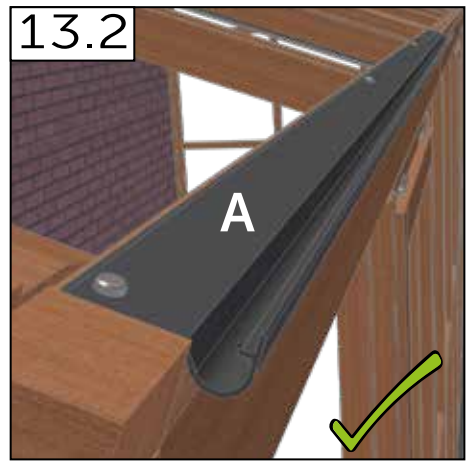

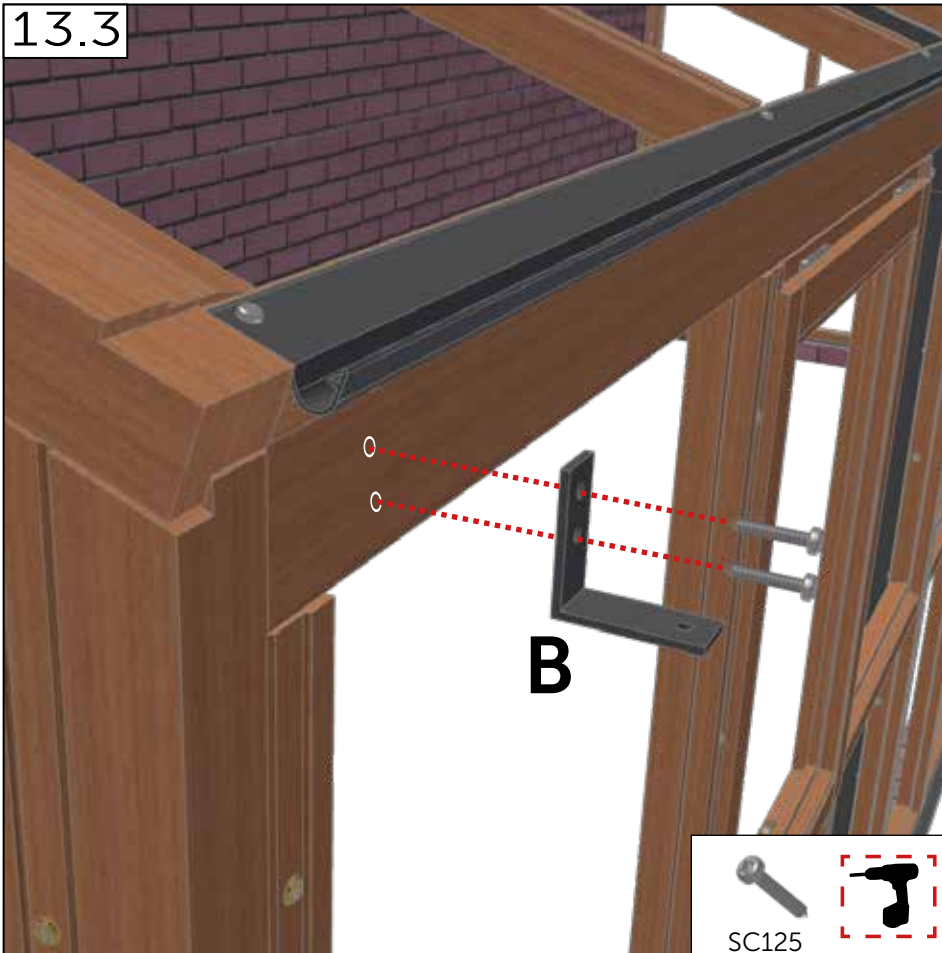

13.3



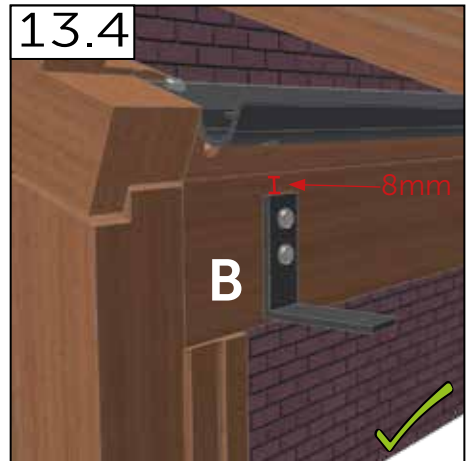







13.4



	#	mm
	A AL2022	-
	SC125	4.2 x 25
	B AL3051	-

# Trims (Extension Length Only) - Garnitures - Trims - Schnitte - Trimmer - Adornos

	#	mm
	LH AL2014	-
	RH AL2014	-
	C AL3018	-
	PT200	MALE FEMALE
	BL122	M6 x 16
	WA500	M6
	NU101	M6
	PT204	-

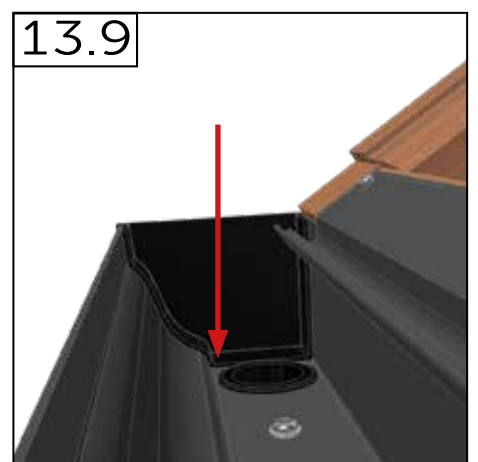
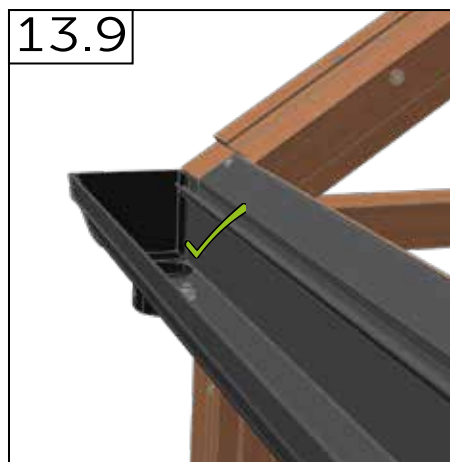
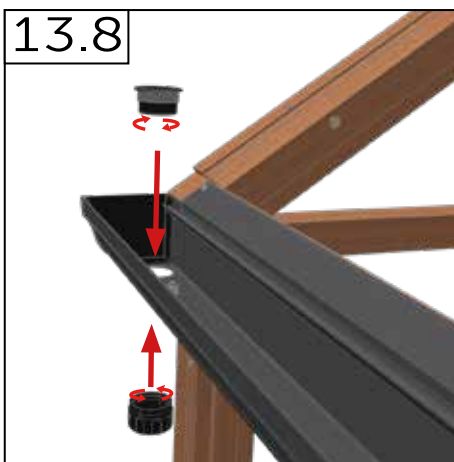
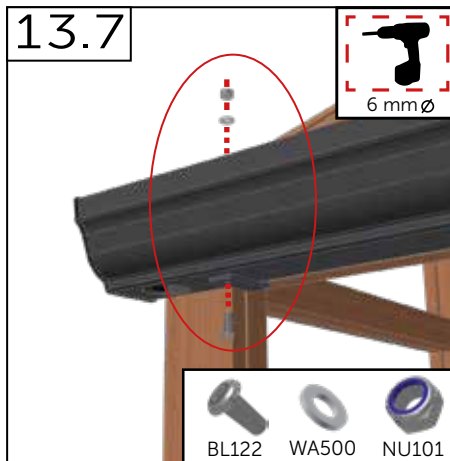
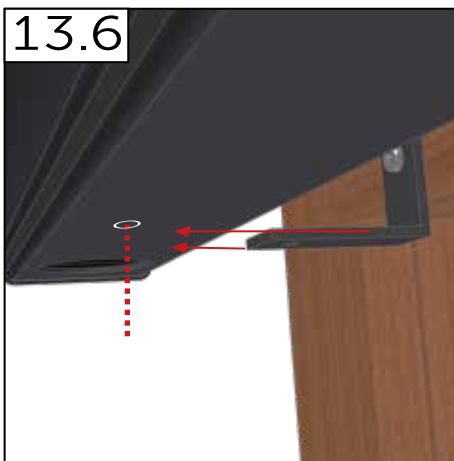
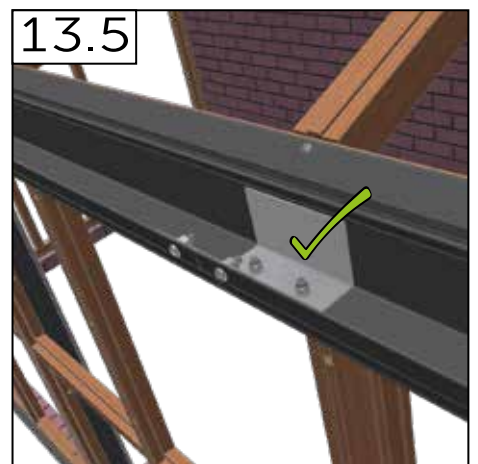
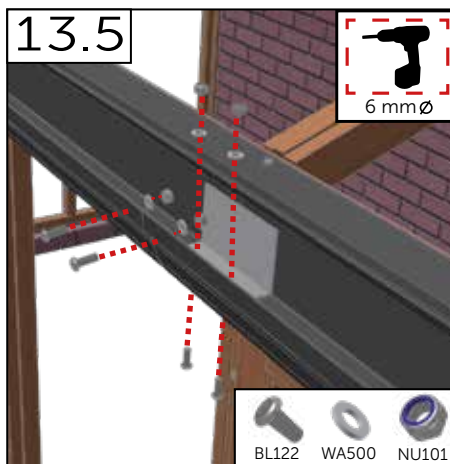
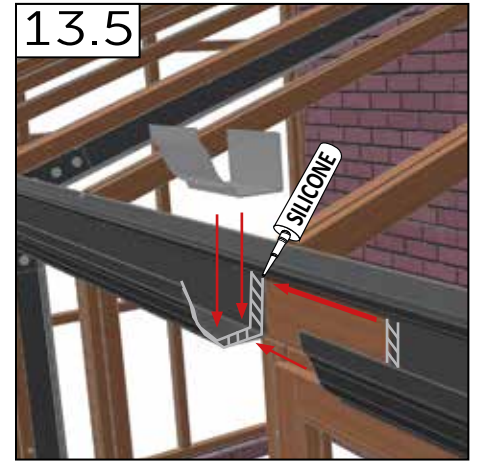
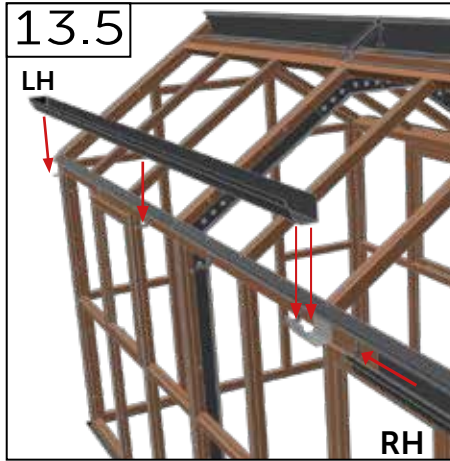



14.0

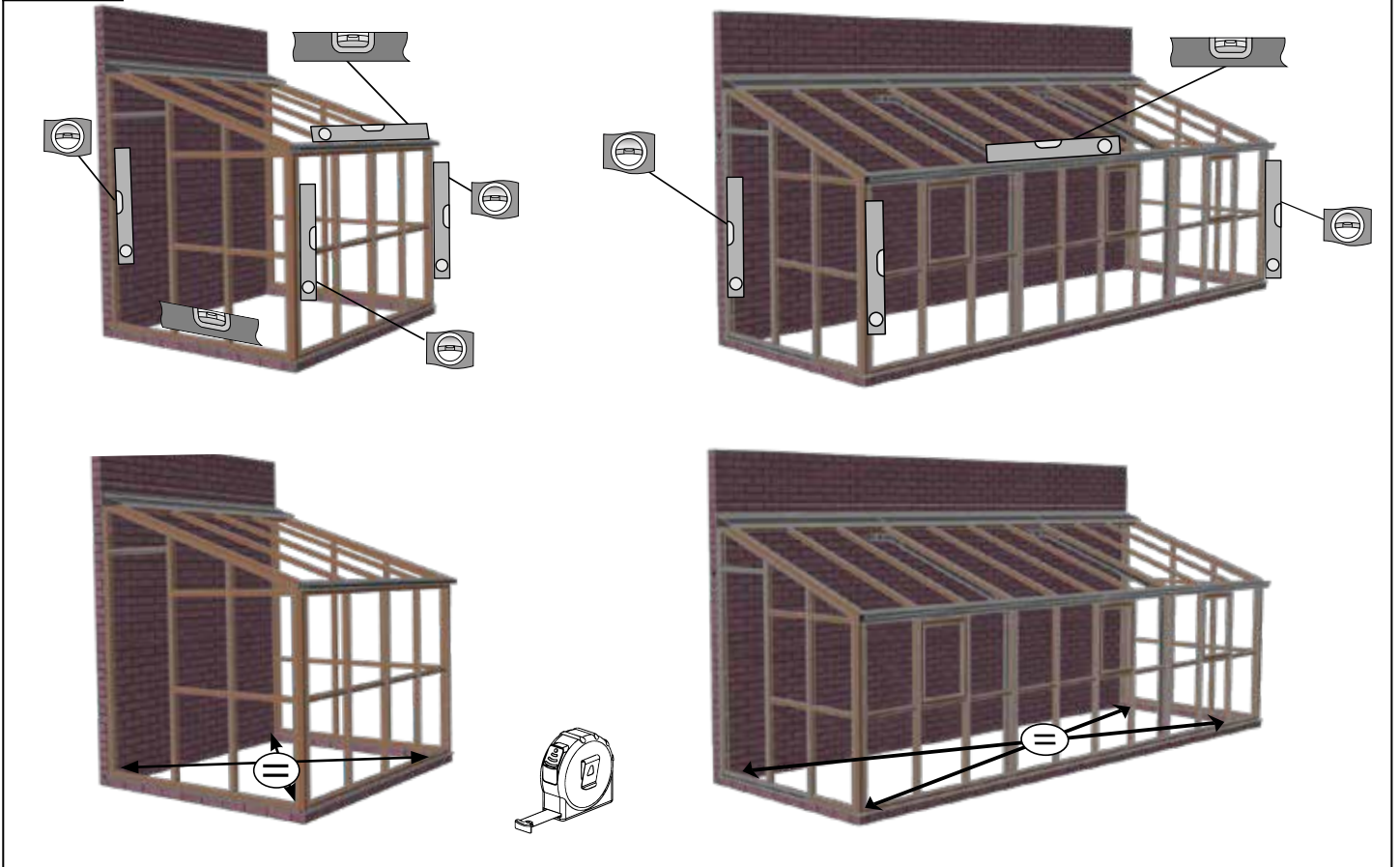

	#	mm
	SC058	4.8 x 100
	WA501	-
	FX200	-

14.1

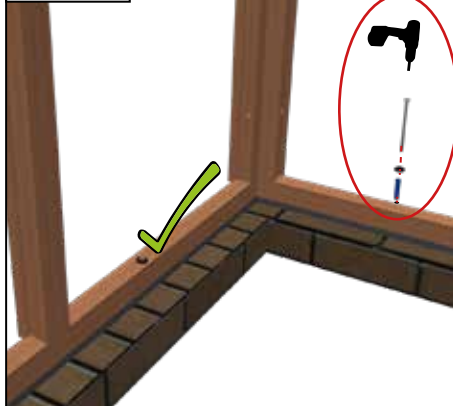

14.2

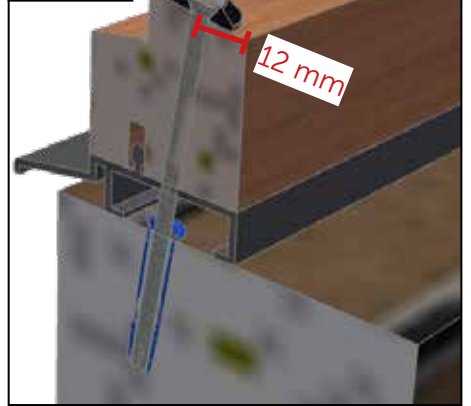

14.3

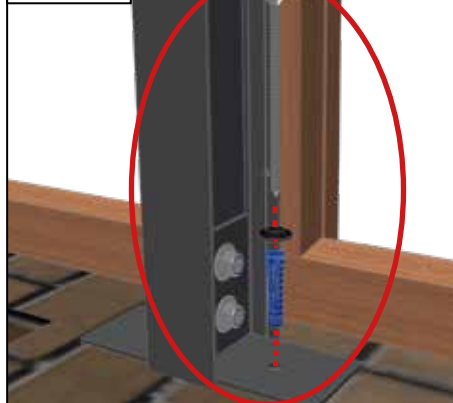

14.4

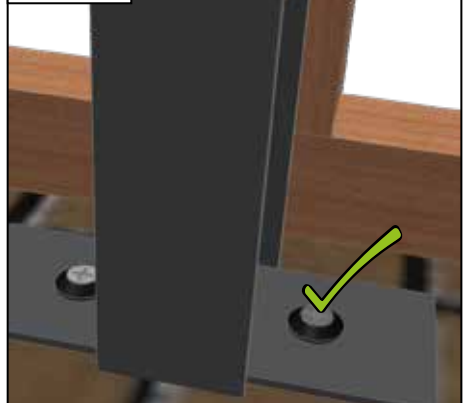

# Glazing - Vitrage - Inglasning - Verglasung - Innglassing - Acristalamiento - Glasering

**15.0**

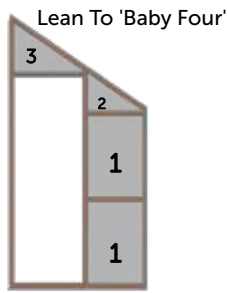

- 1. 0488 x 0717
- 2. 0488 x 0349
- 3. 0602 x 0442

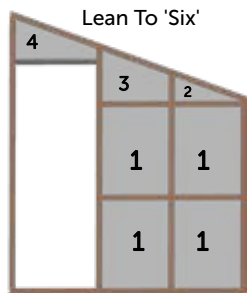

- 1. 0545 x 0717
- 2. 0545 x 0216
- 3. 0545 x 0425
- 4. 0660 x 0337

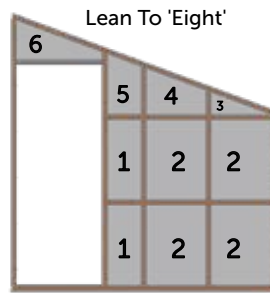

- 1. 0315 x 0717
- 2. 0545 x 0717
- 3. 0545 x 0216
- 4. 0545 x 0425
- 5. 0315 x 0550
- 6. 0775 x 0364

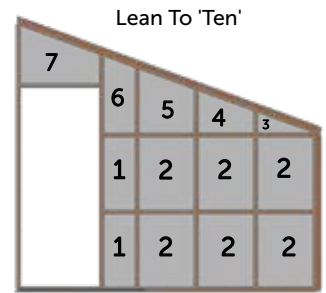

- 1. 0315 x 0717
- 2. 0545 x 0717
- 3. 0545 x 0216
- 4. 0545 x 0425
- 5. 0545 x 0627
- 6. 0315 x 0759
- 7. 0775 x 0573

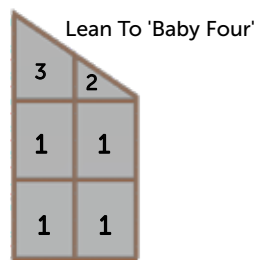

- 1. 0545 x 0717
- 2. 0545 x 0388
- 3. 0545 x 0780

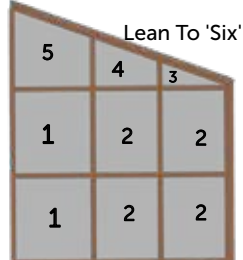

- 1. 0660 x 0717
- 2. 0545 x 0717
- 3. 0545 x 0216
- 4. 0545 x 0425
- 5. 0660 x 0675

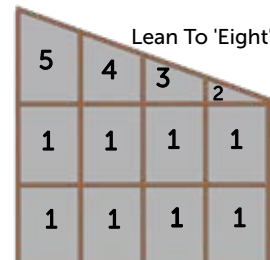

- 1. 0545 x 0717
- 2. 0545 x 0216
- 3. 0545 x 0425
- 4. 0545 x 0627
- 5. 0545 x 0842

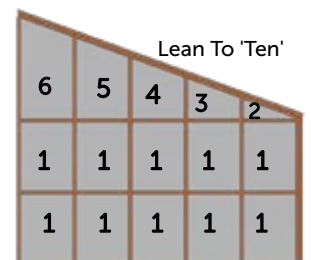

- 1. 0545 x 0717
- 2. 0545 x 0216
- 3. 0545 x 0425
- 4. 0545 x 0627
- 5. 0545 x 0842
- 6. 0545 x 1051

**15.1**

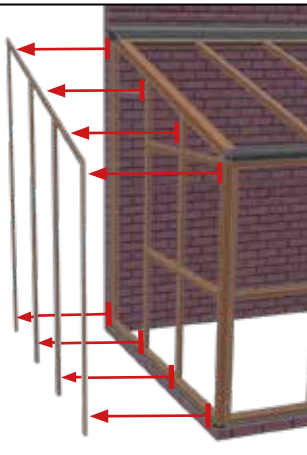

**15.2**

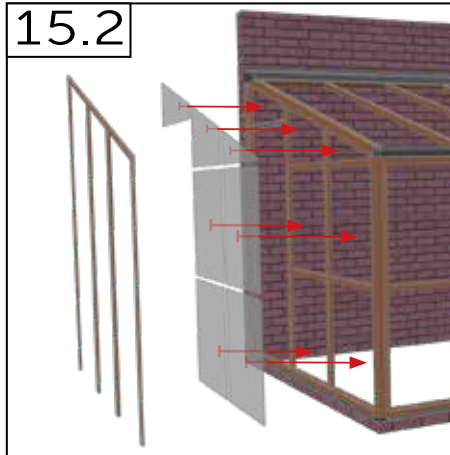

**15.3**

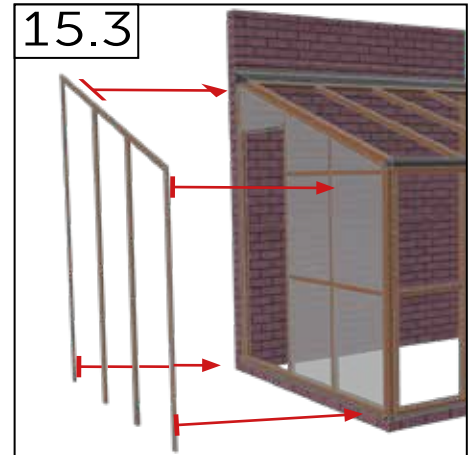

**15.4**

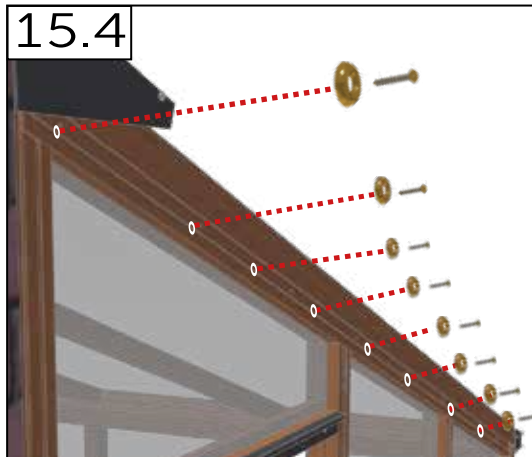

	#	mm
	GLASS	-
	A AL2009	-
	SC125	4.2 x 25
	SC305	3.5 x 32
	WA300	No. 6



# Glazing - Vitrage - Inglasning - Verglasung - Innglassing - Acristalamiento - Glasering

16.0

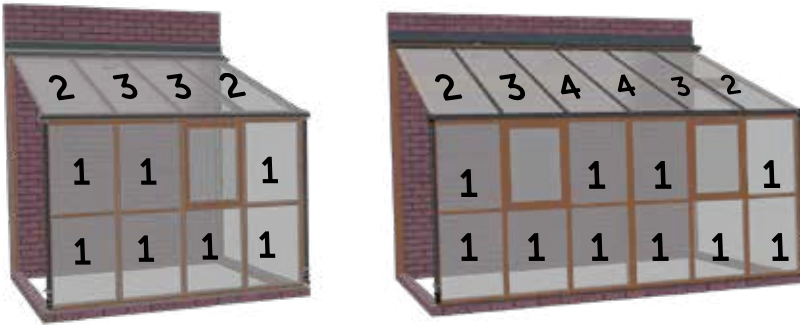

Lean To 'Baby Four'

1. 0545 x 0717
2. 0589 x 1310
3. 0555 x 1310
3. 0570 x 1310

Lean To 'Six'

1. 0545 x 0717
2. 0589 x 1863
3. 0555 x 1863
4. 0570 x 1863

Lean To 'Eight'

1. 0545 x 0717
2. 0589 x 2352
3. 0555 x 2352
4. 0570 x 2352

Lean To 'Ten'

1. 0545 x 0717
2. 0589 x 1502
3. 0555 x 1502
4. 0570 x 1502

16.1

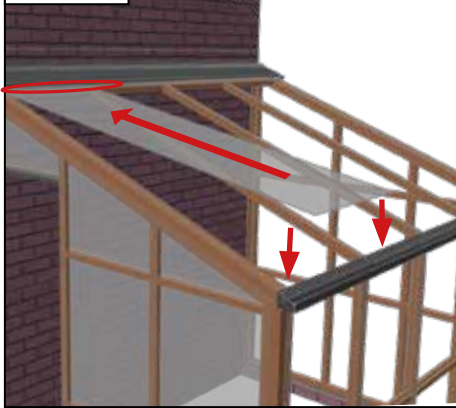

16.2



16.3

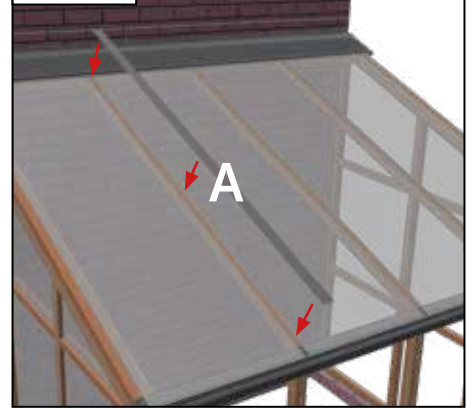

16.4

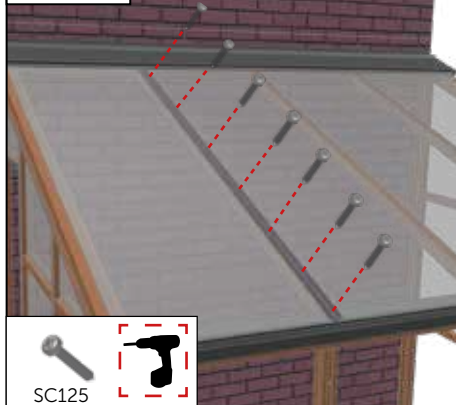

SC125

16.5

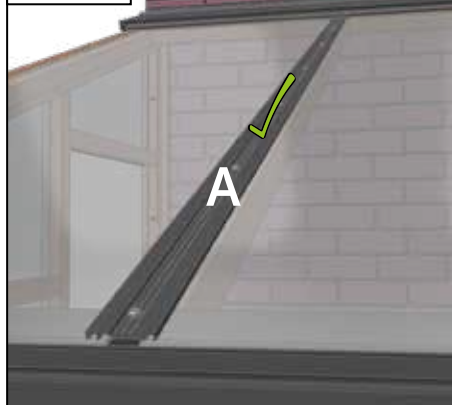

16.6

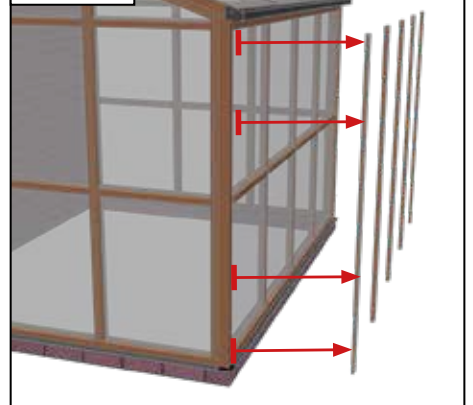

16.7

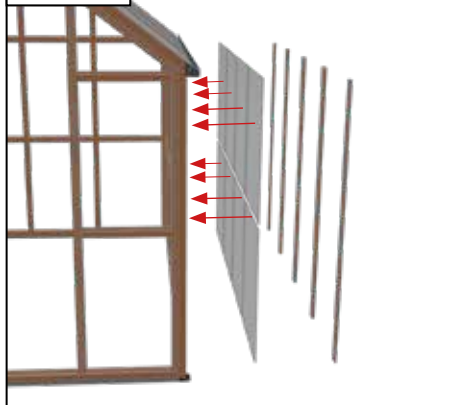

16.8

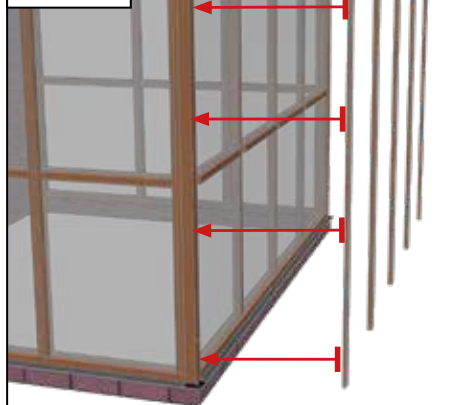

16.9

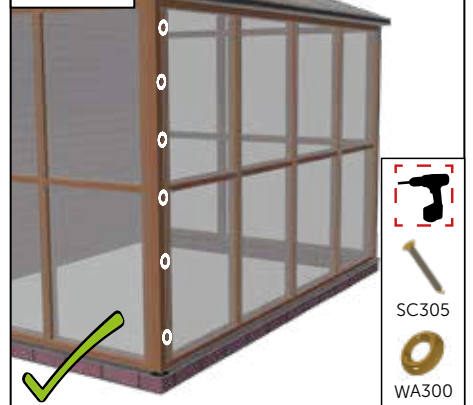

SC305

WA300



# Glazing (Lean To 'Ten') - Vitrage - Inglasning - Verglasung - Innglassing - Acristalamiento - Glasering

16.0

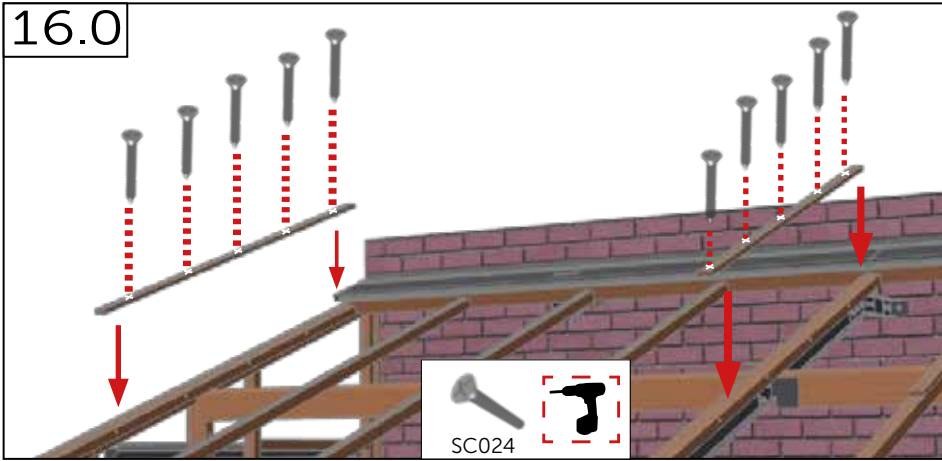

16.1

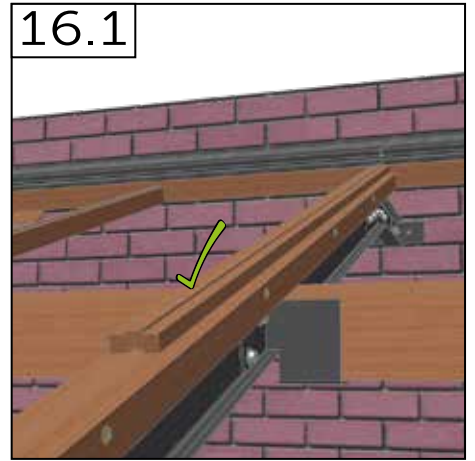

	#	mm
	W064	1445
	W065	1649
	SC125	4.2 x 25
	SC024	4.2 x 38

16.1

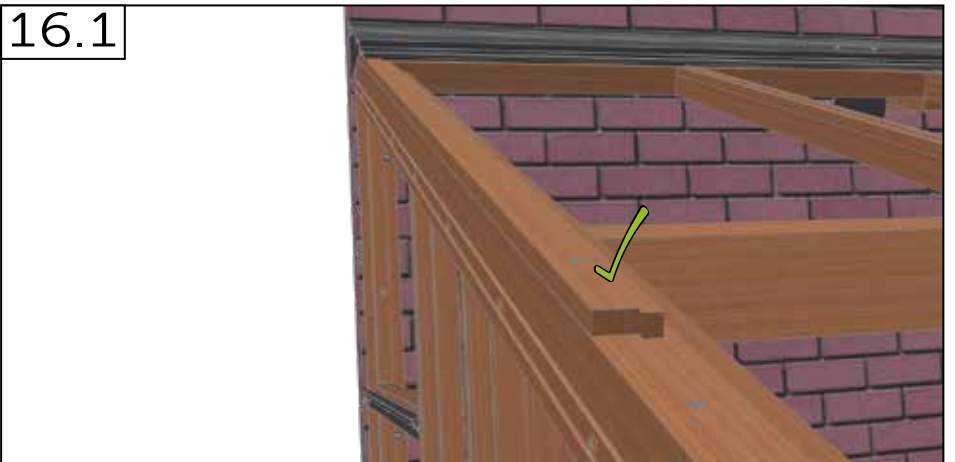

16.2

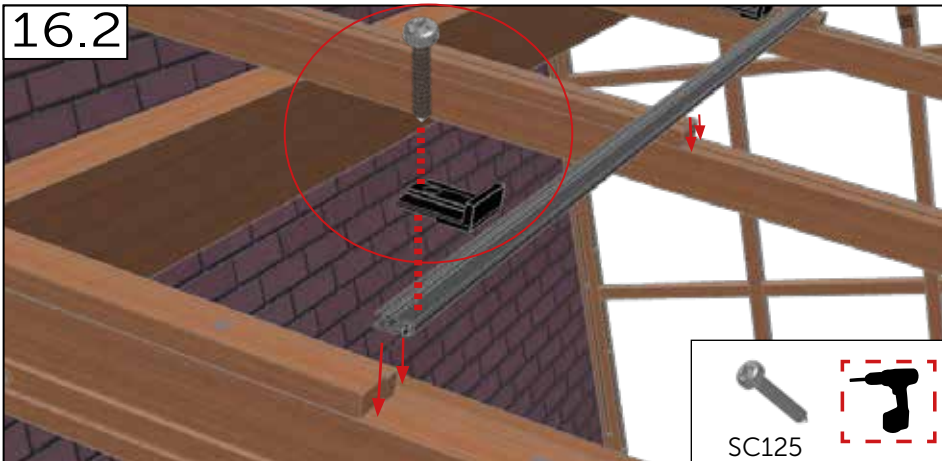

16.3

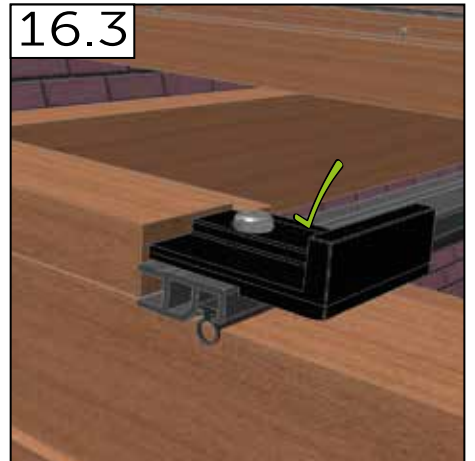

16.4

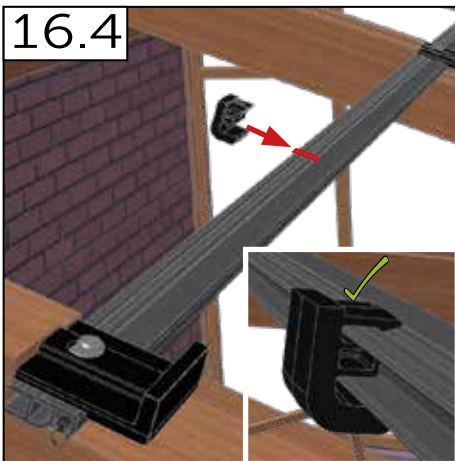

16.5



16.6

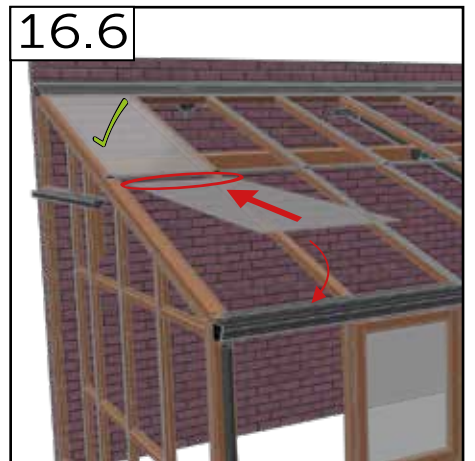

Single Door - Porte simple - Enkel dörr - Einzeltür - Enkel dør  
 - Puerta sencilla - Enkelt dør

17.0

AL2007/0020

	#	mm
	AL2007 /0020	-
	SC005	3.5 x 25
	C AL2006	-
	SC125	4.2 x 25
	D AL2542	-

17.1

SC005

17.2

17.3

C

17.4

C

17.5

SC125

17.6

D

SC005

17.7



Single Door - Porte simple - Enkel dörr - Einzeltür - Enkel dør  
 - Puerta sencilla - Enkelt dør

18.0

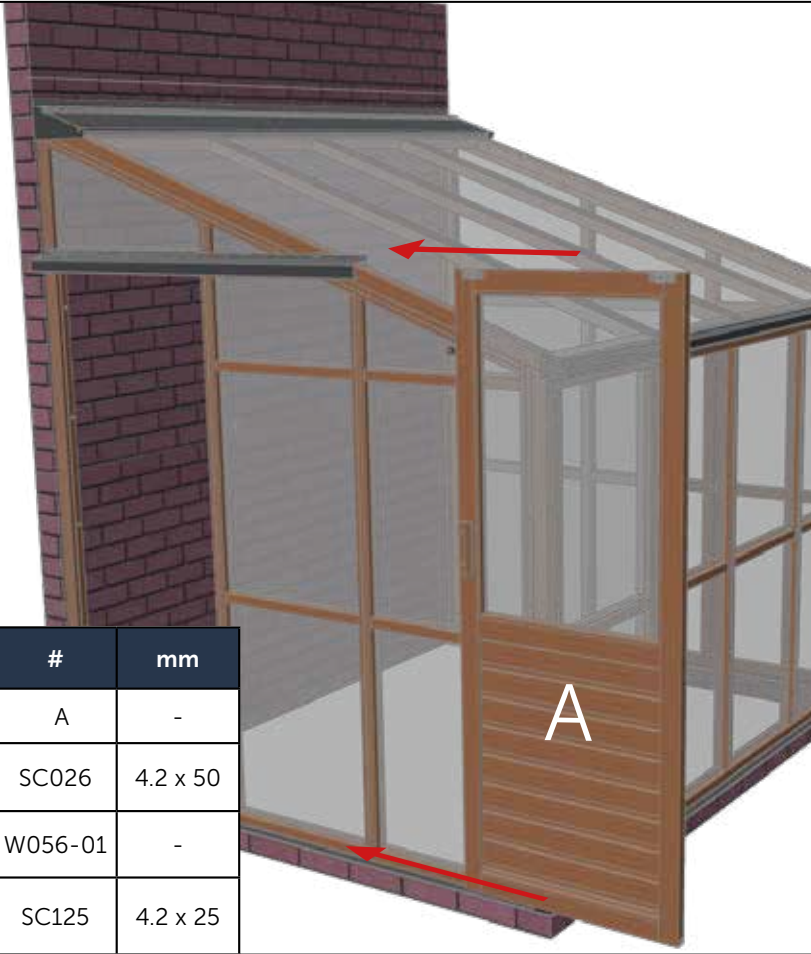

	#	mm
	A	-
	SC026	4.2 x 50
	W056-01	-
	SC125	4.2 x 25

18.1

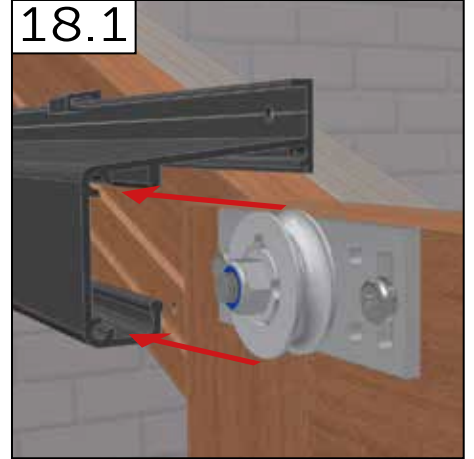

18.2

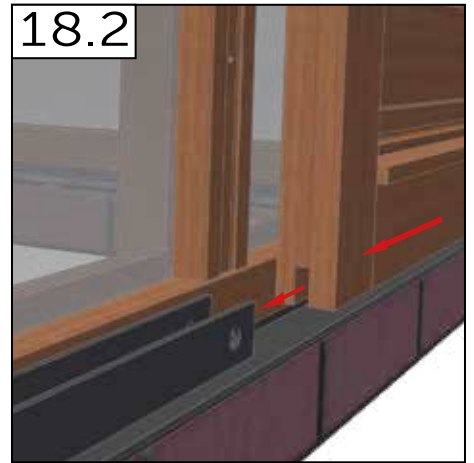

18.3

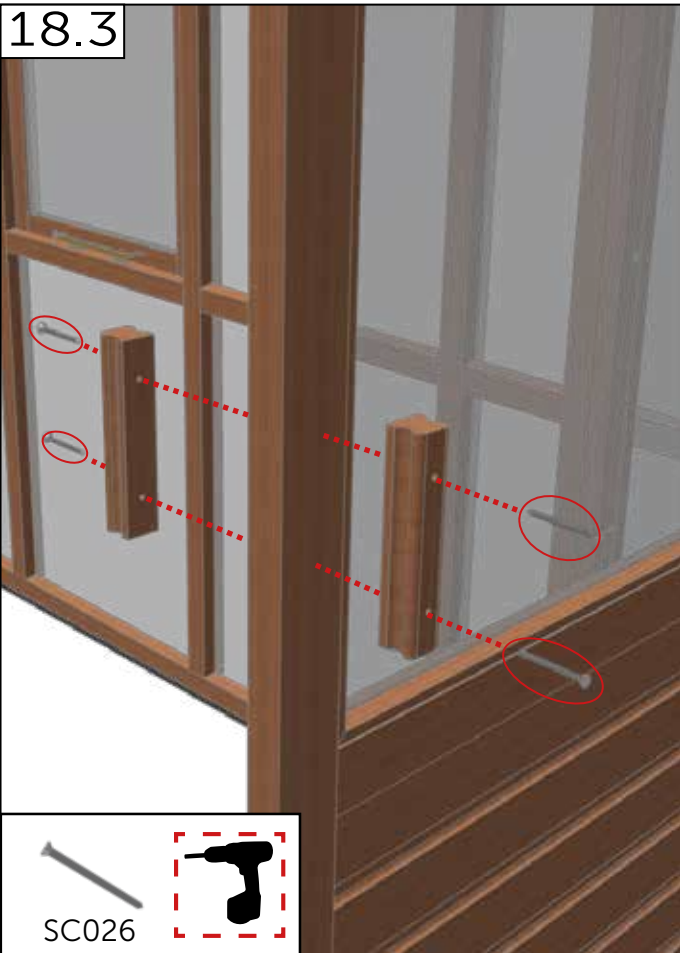

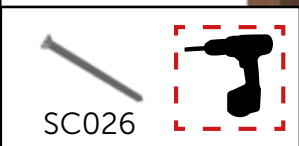
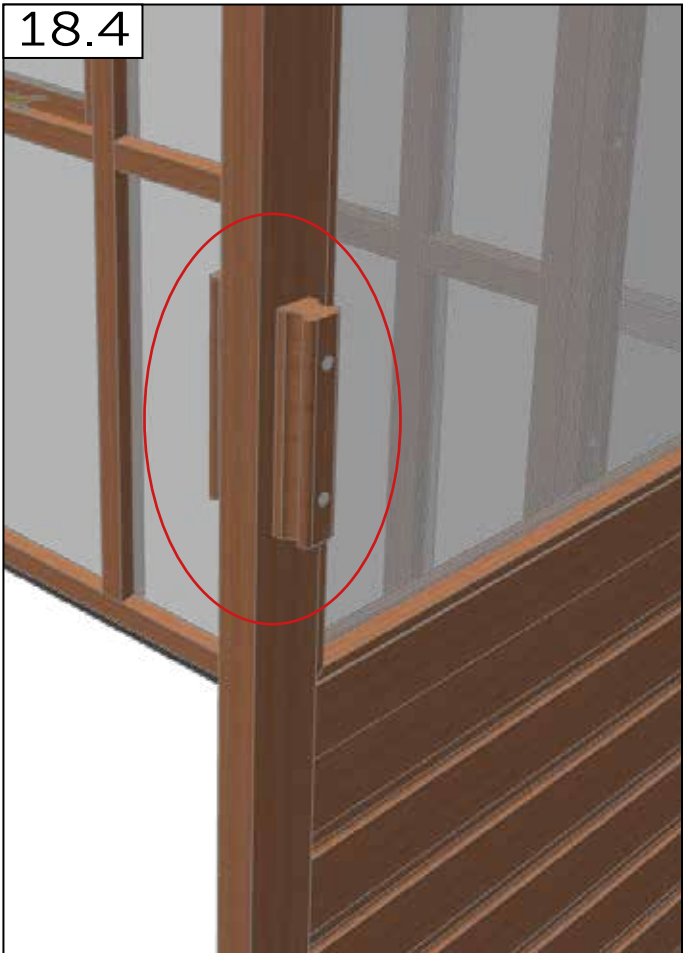

18.4





19.0



	#	mm
	SC121	4.2 x 9.5
	AL3002	-



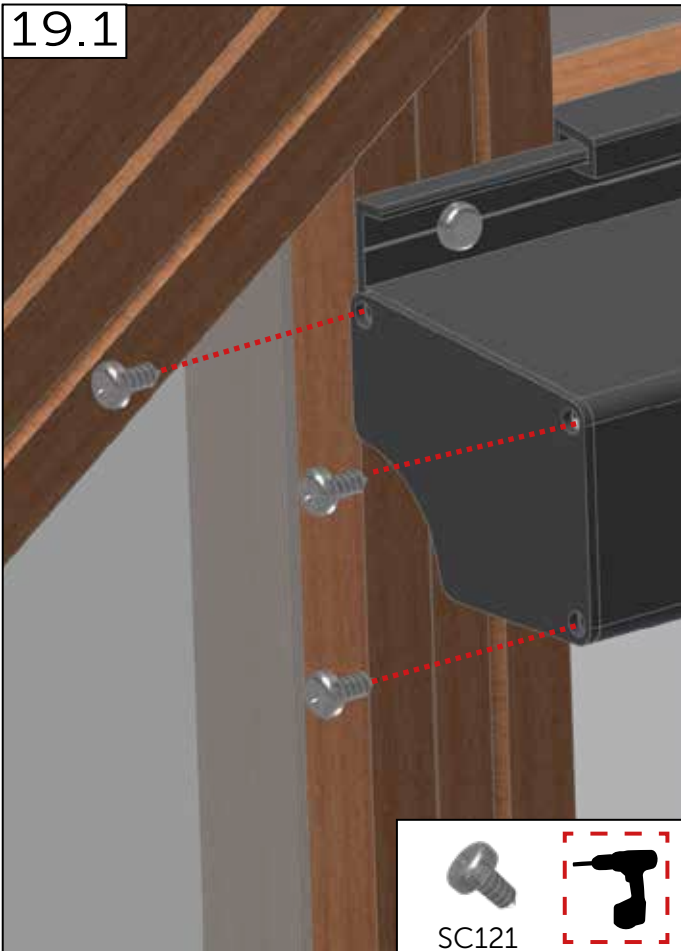

19.1

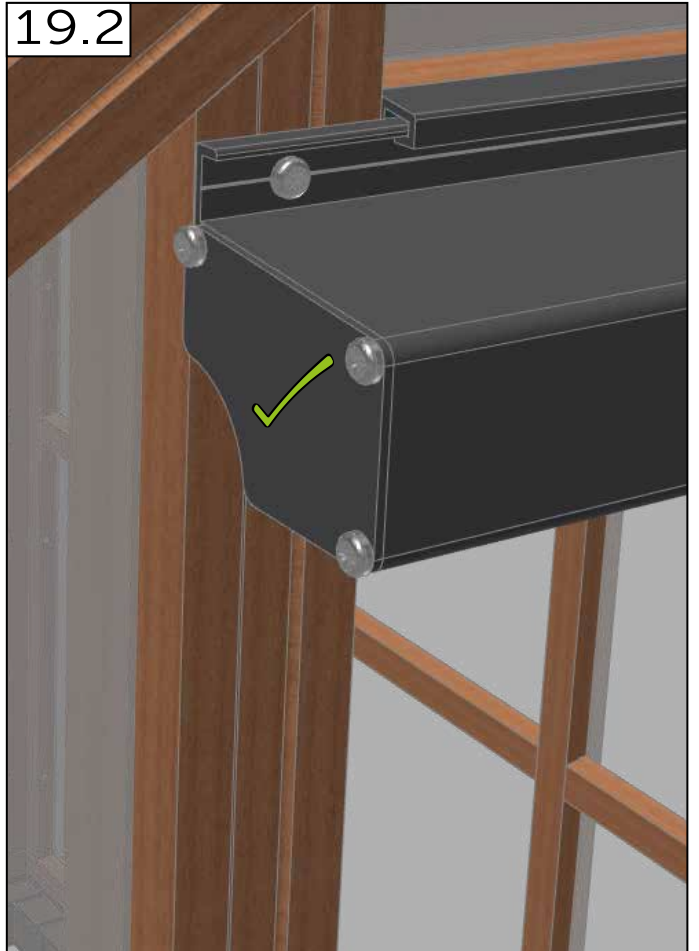

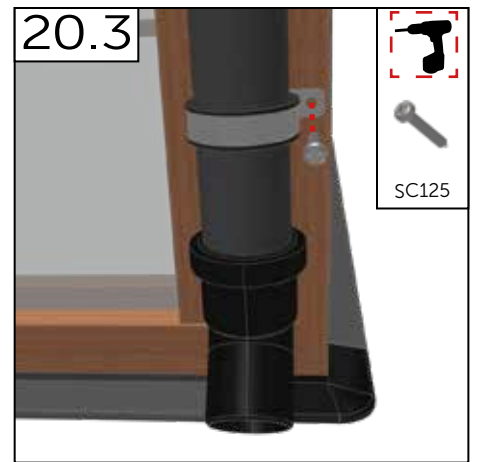
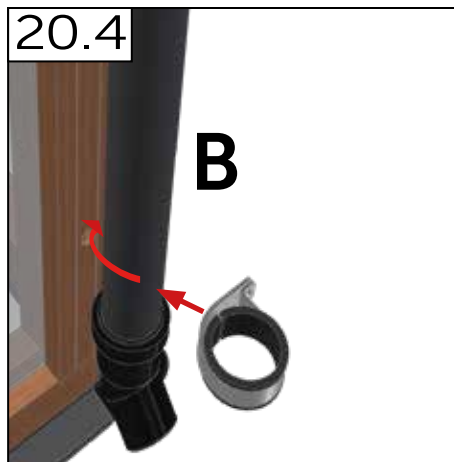
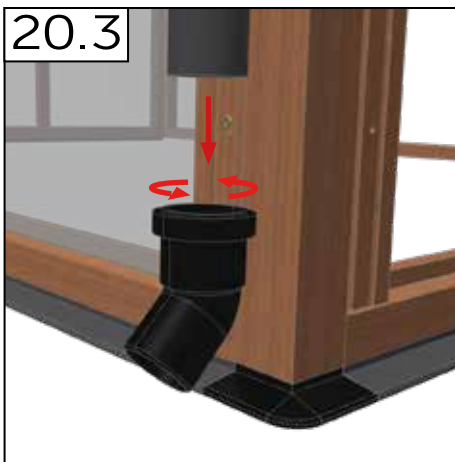
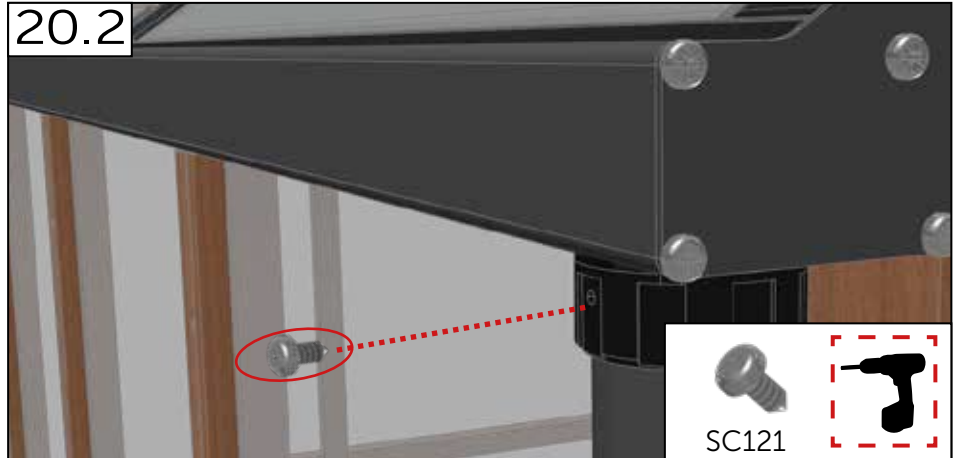
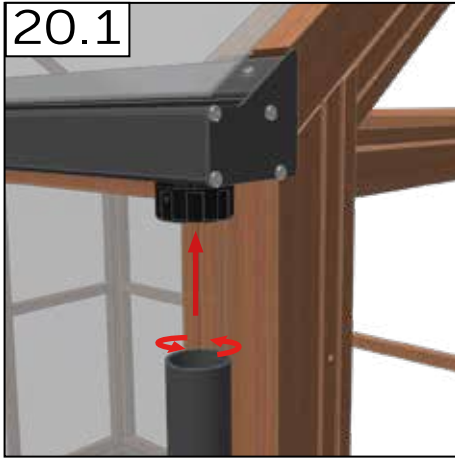
19.2





	#	mm
	SC121	4.2 x 9.5
	SC125	4.2 x 25
	B AL2016	1447
	PT201	-
	PT203	-









GABRIEL ASH

[www.gabrielash.com](http://www.gabrielash.com)

As part of our policy of continuous development and improvement.  
We reserve the right to modify any of the information set out within this document and any related documentation at any time without notice.

This product is delivered by a company in the Juliana Group - [www.juliana.com](http://www.juliana.com)

®The Royal Horticultural Society. The Royal Horticultural Society, and its logo, are trade marks of The Royal Horticultural Society.

(Registered Charity No. 222879/SC038262) and used under licence from RHS Enterprises Limited.