

# Installation Guide



GABRIEL ASH

RHS 'Portico'



RHS 'Grand Portico'



RHS 'Portico' Planthouse















RHS 'Grand Portico' Planthouse



RHS

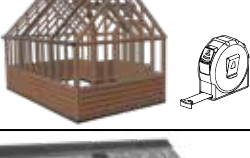

Overview - Oversigt - Übersicht - Översikt - Détails -  
 Overzicht - Sisällys - Zawartość - Oversikt - Visión general

	
	4 - 6
	7 - 9
	10 - 12
	13 - 19
	20 - 23
	24 - 37
	38 - 44
	45 - 47
	48
	49 - 52
	53

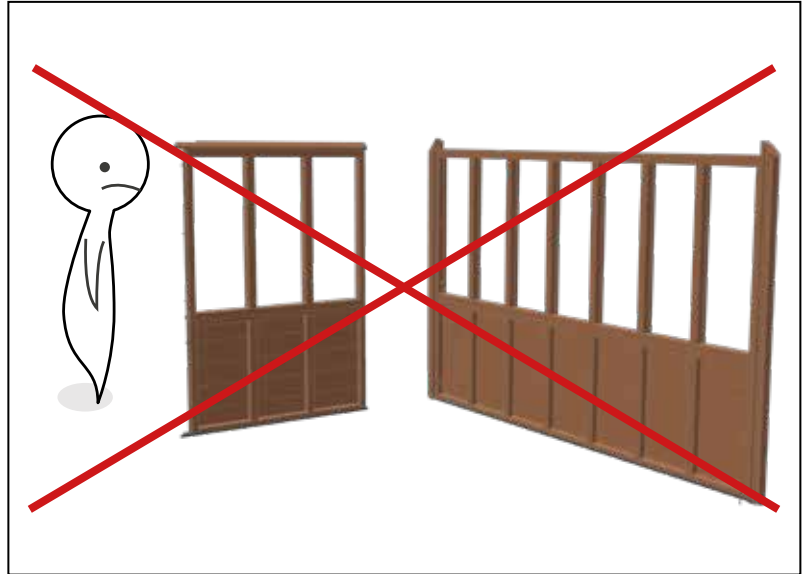

Portal Frame - Portalramme - Portalrahmen - Portal ram - Portique - Portaal frame -  
 Portaalin kehys - Rama portalu - Portalramme - Marco del pórtico

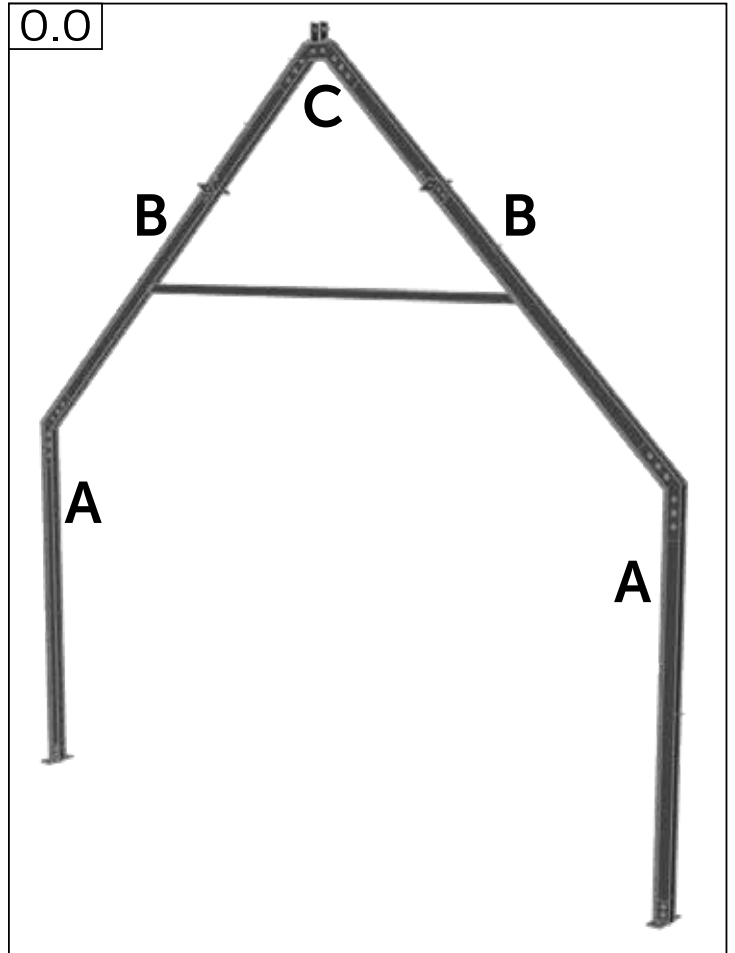
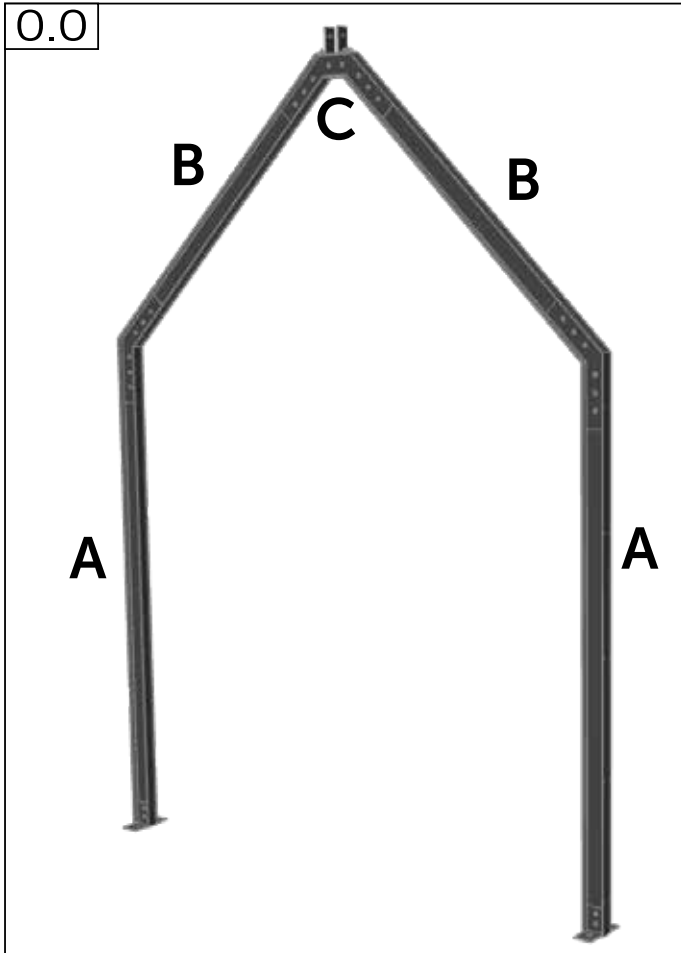

	#	mm
	AL3067	-
	AL3060	-
	AL3059	-
	A AL2018	1559
	B AL2018	0851
	B AL2018	1199
	B AL2018	1596
	B AL2018	1894
	C AL3071	0341
	BL153	M8 x 20
	WA205	M8
	NU102	M8

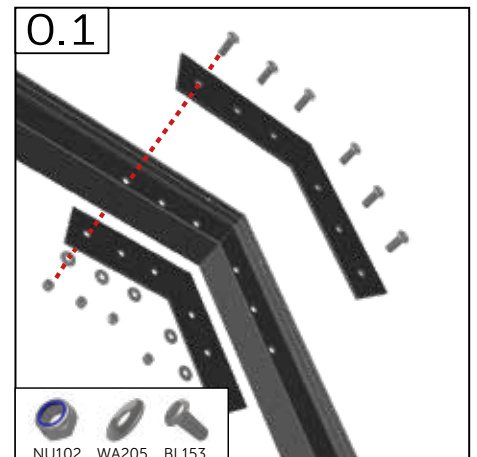
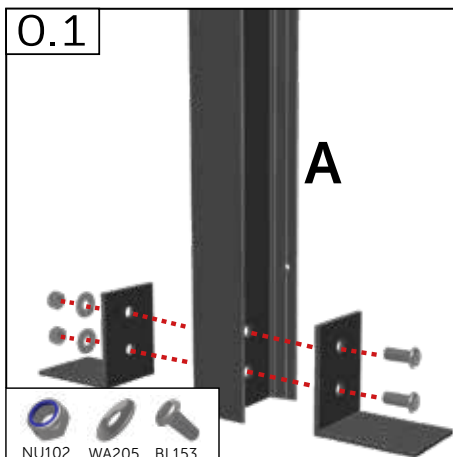
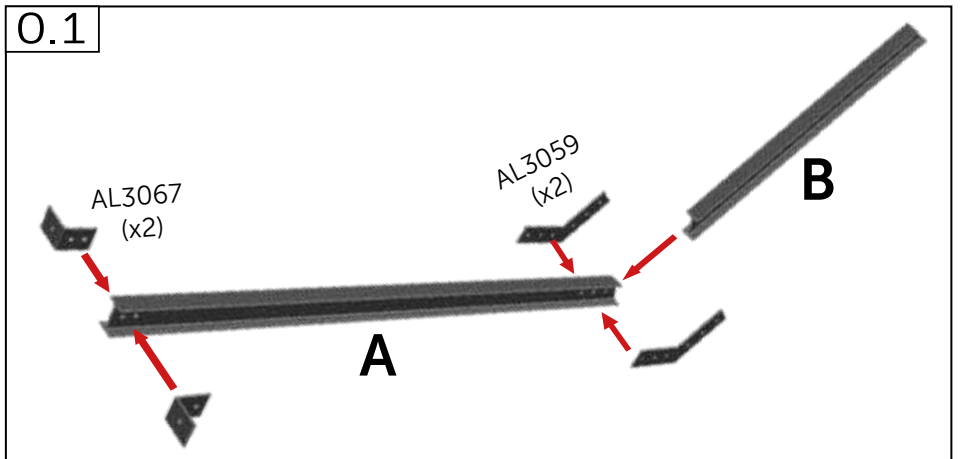

0.2

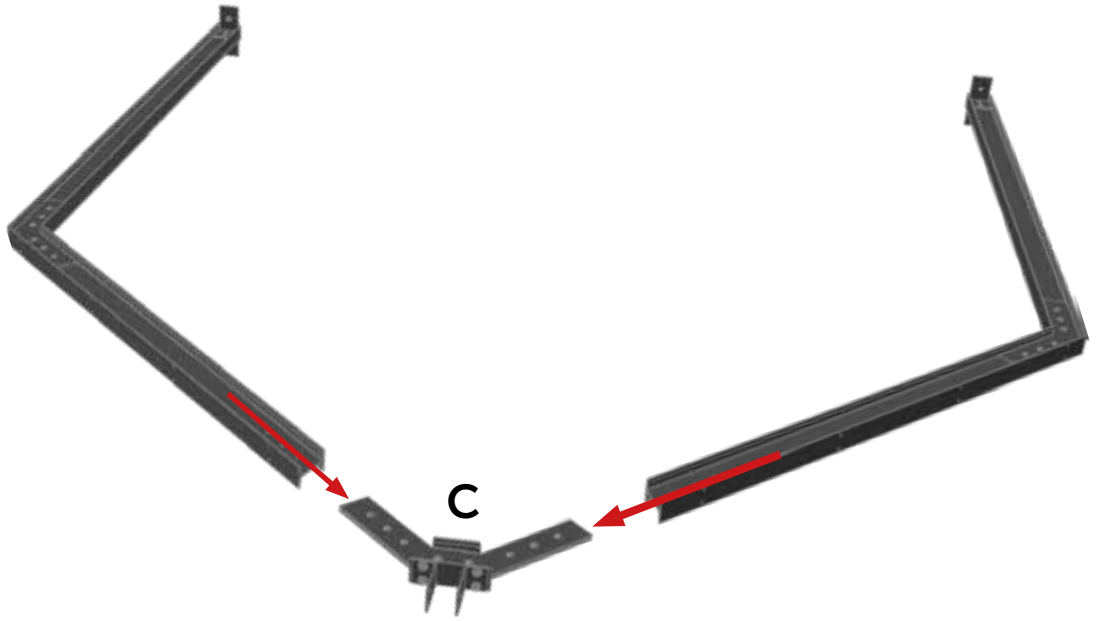

0.3

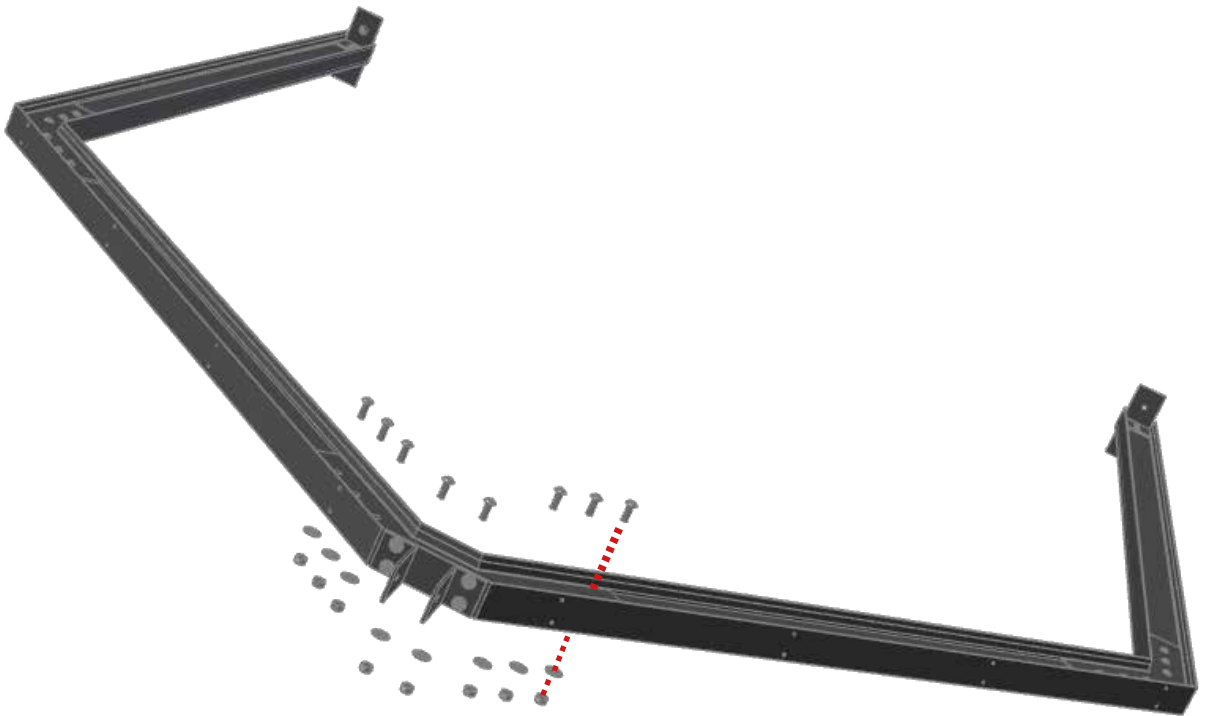

0.4



(Grand Portico Only) Portal Frame - Portalramme - Portalrahmen - Portal ram - Portique  
 - Portaal frame - Portaalin kehys - Rama portalu - Portalramme - Marco del pórtico

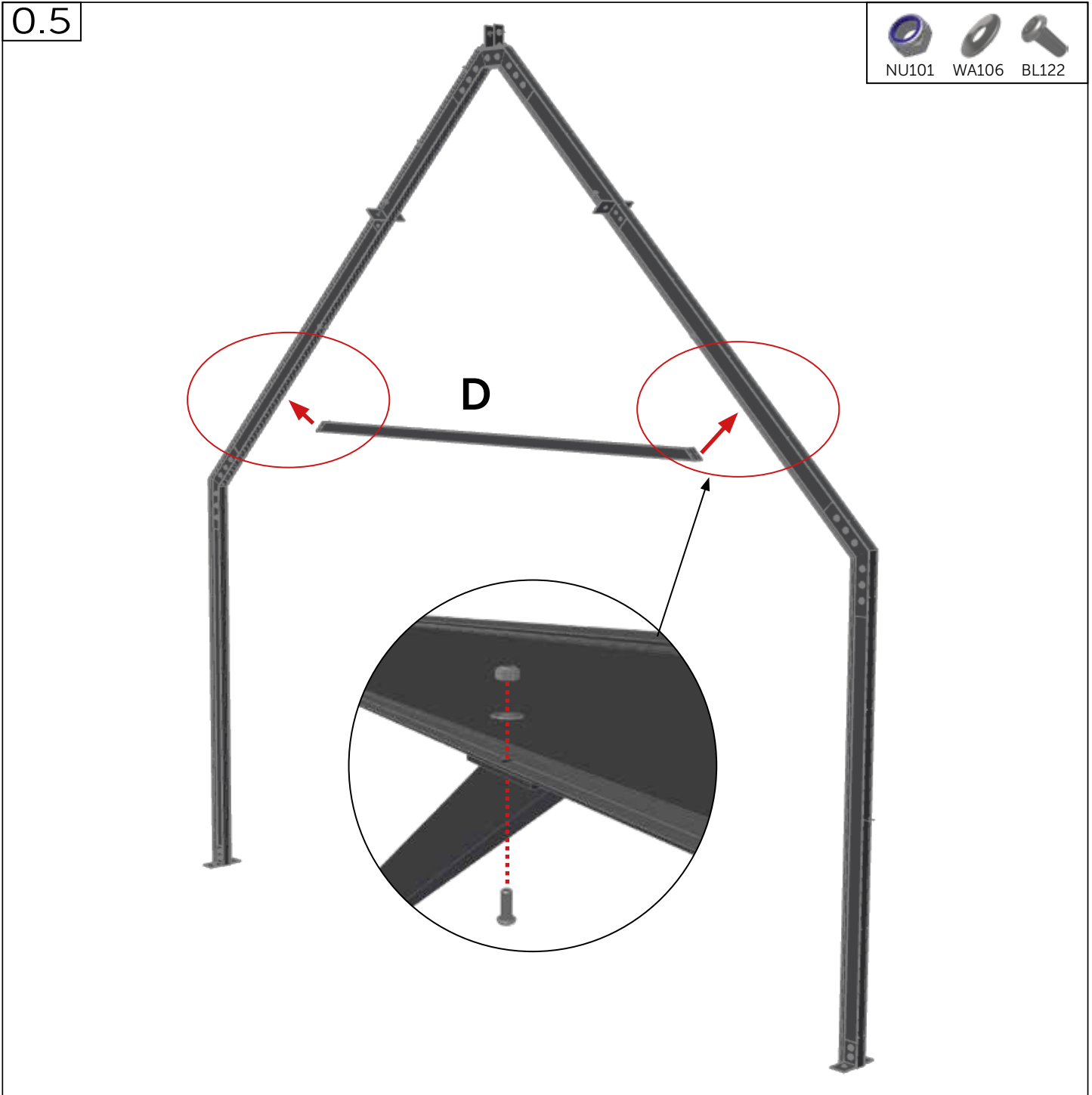

	#	mm
	D AL3086	1973
	BL122	M6 x 16
	WA106	M6
	NU101	M6

1.0

RHS 'Portico' Gable

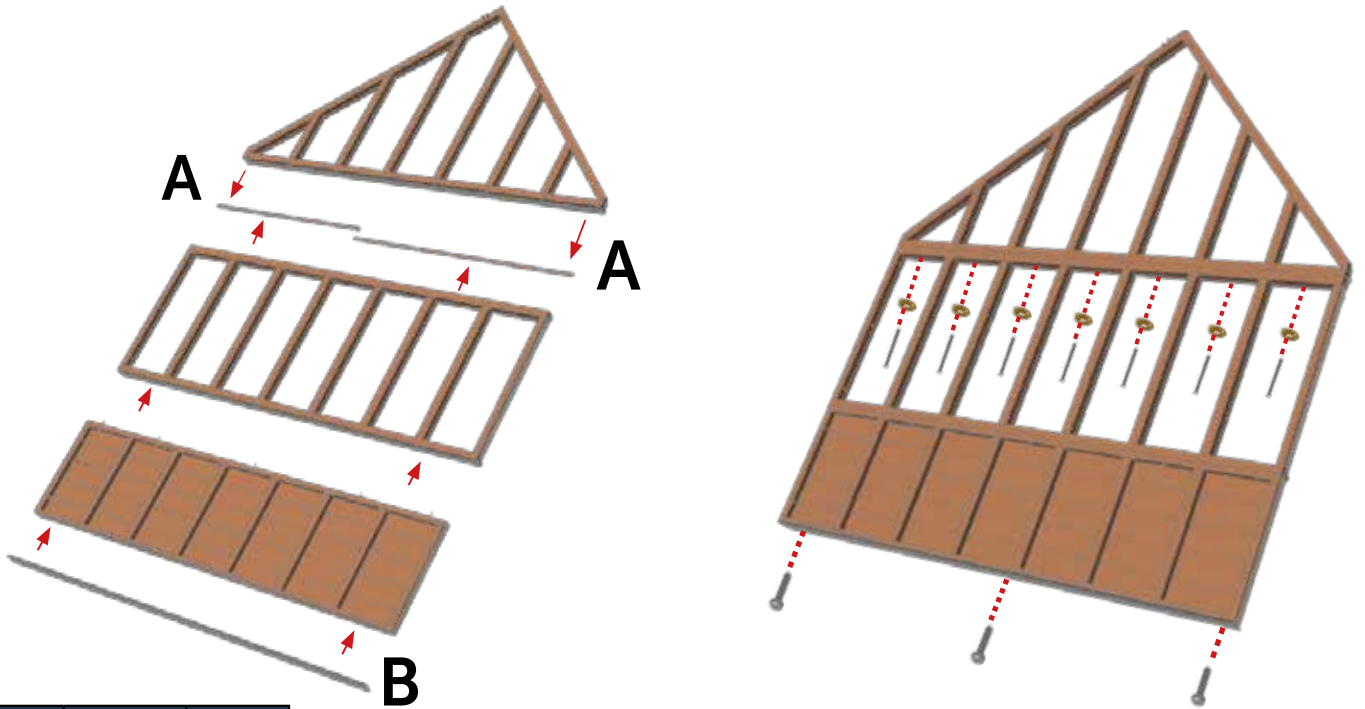



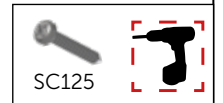

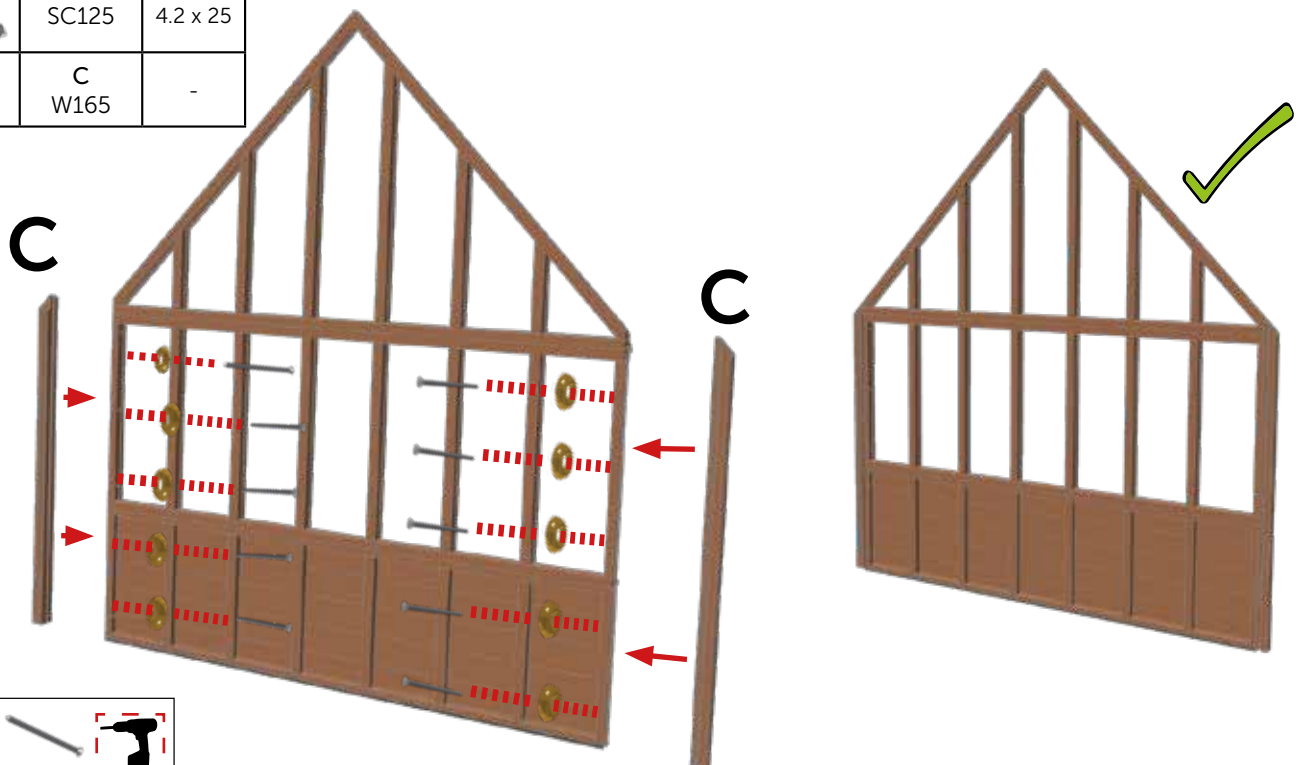

	#	mm
	SC027	4.2 x 65
	SC301	No. 8
	A W900	-
	B AL2004	-
	SC125	4.2 x 25
	C W165	-



1.1



# Gables - Gavle - Giebel - Gavlar - Pignons - Gevels - Päädýt - ściana szczytowa - Gavler - Aguilones

1.0	#	mm
	SC027	4.2 x 65
	SC301	No. 8
	A W900	-
	B AL2004	-
	SC125	4.2 x 25
	C W165	-
	D W135	-

RHS 'Grand Portico' Gable

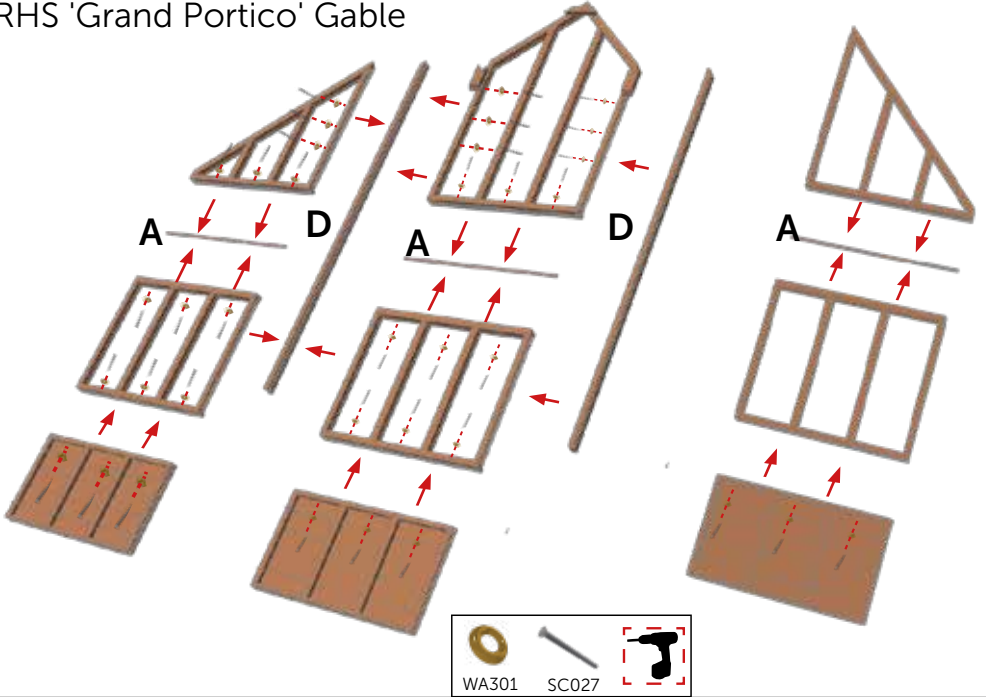

1.1

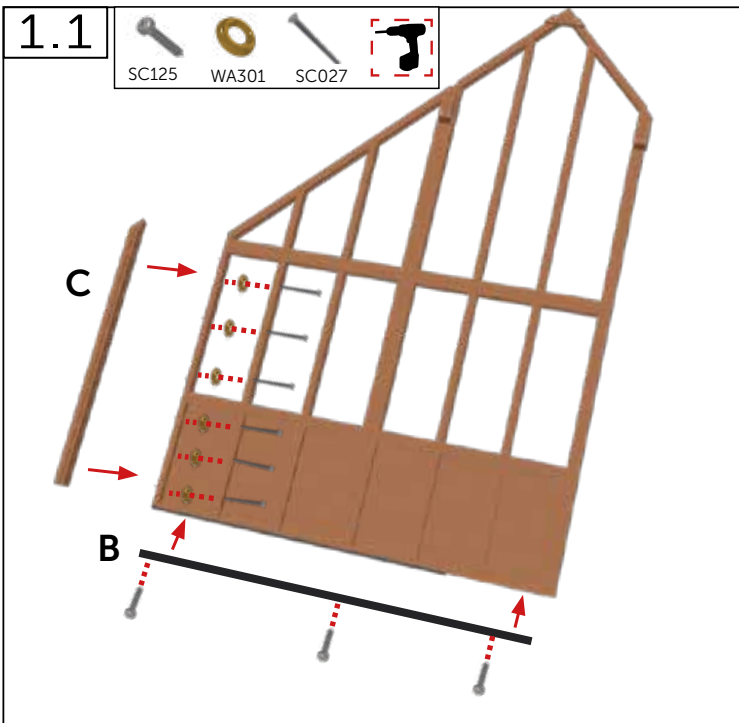

SC125 WA301 SC027

1.2

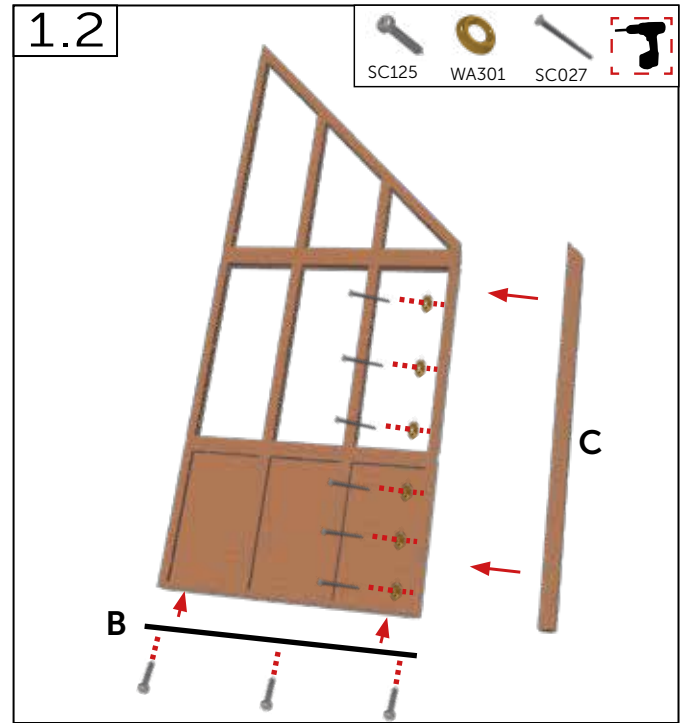

SC125 WA301 SC027

1.3

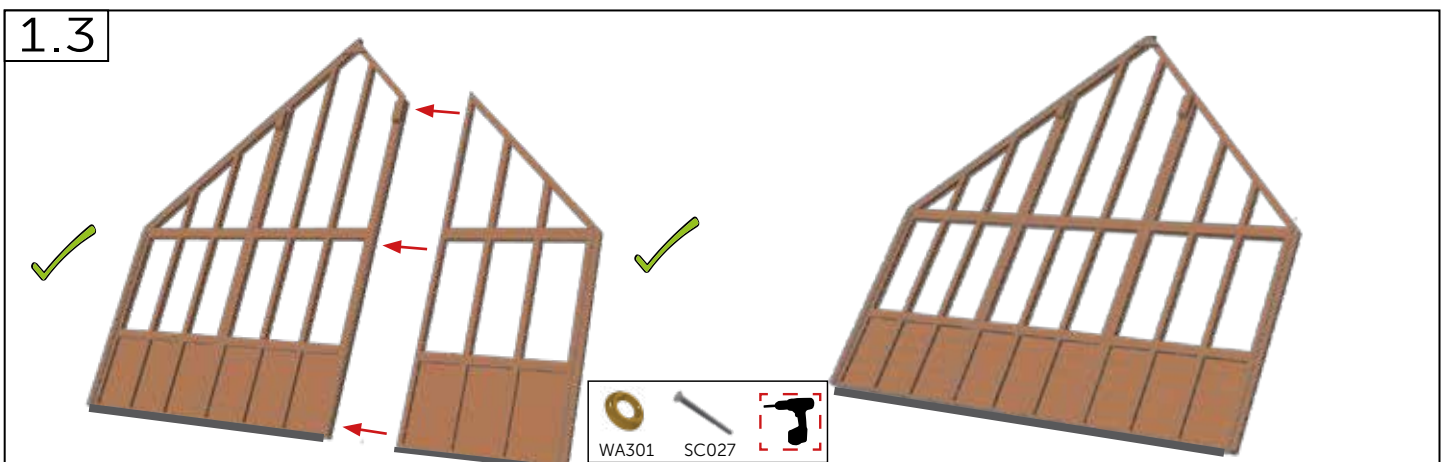

WA301 SC027



# Front Gables - Sider - Seiten - Sidor - Côtés - Zijkanten - Sivut - Boki - Sider - La-dos

**1.0**

#	mm
SC027	4.2 x 65
SC301	No. 8
A W900	-
B AL2004	-
SC125	4.2 x 25
C W165	-
D W135	-

Porch Gable

SC125 WA301 SC027

**1.1**

WA301 SC027

2.0

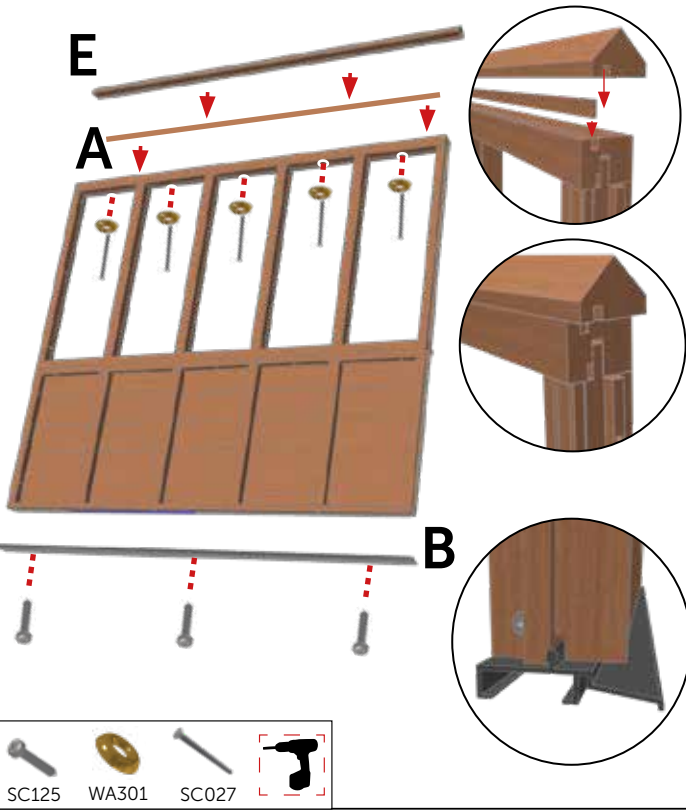

2.1

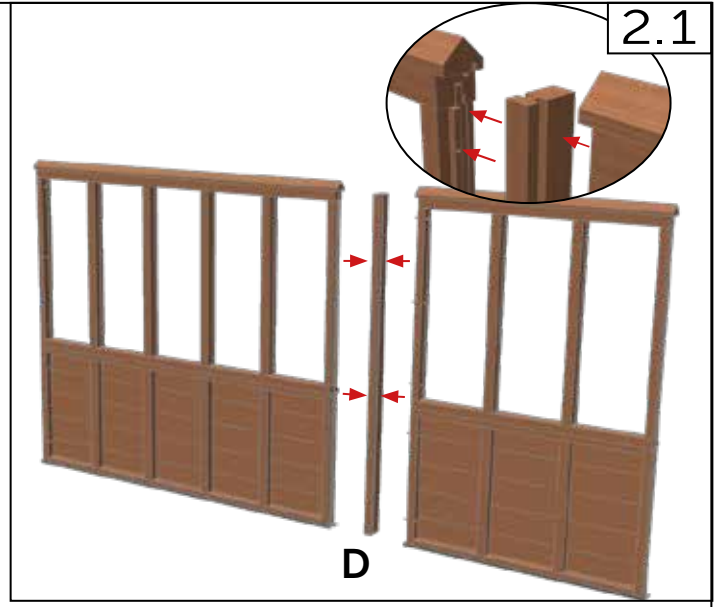

2.2

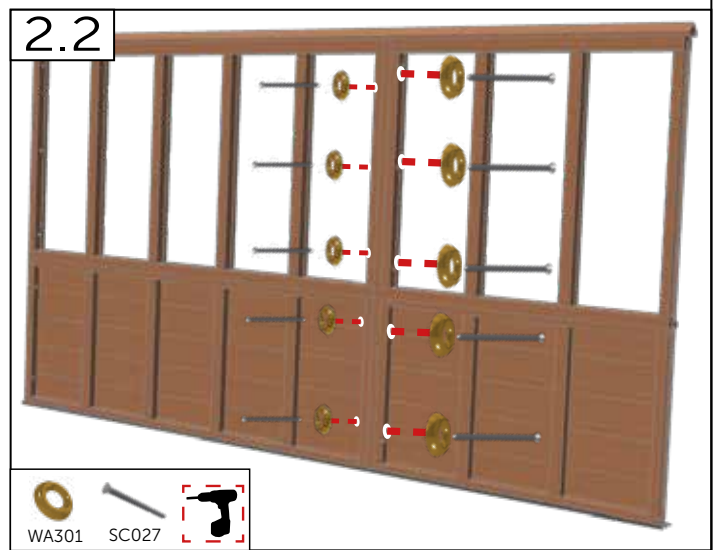

	#	mm
	E W130	-
	A W900	-
	SC027	4.2 x 65
	WA301	No. 8
	B AL2004	-
	SC125	4.2 x 25
	D W135	-

11 PANEL

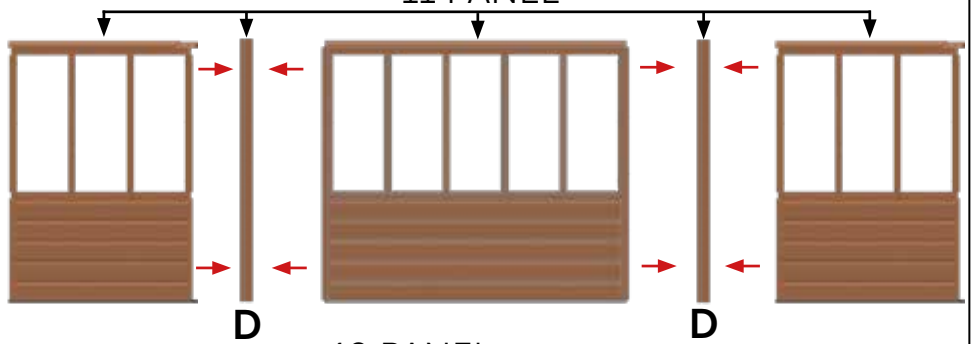

12 PANEL

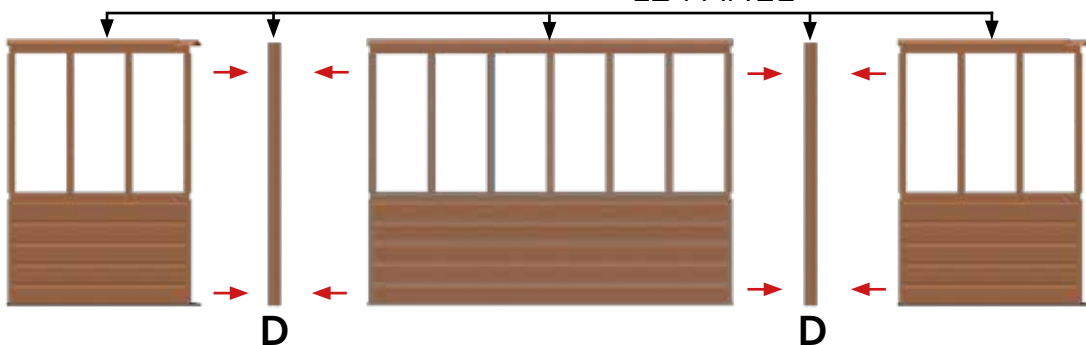

2.3

13 PANEL

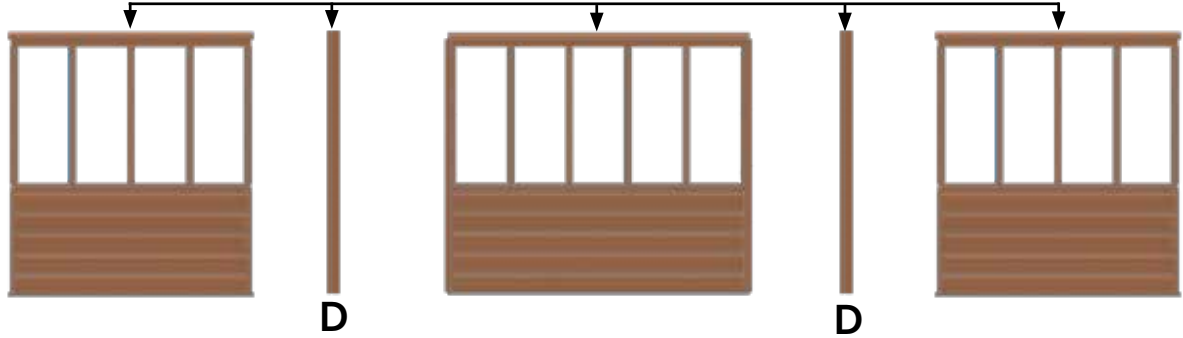

14 PANEL

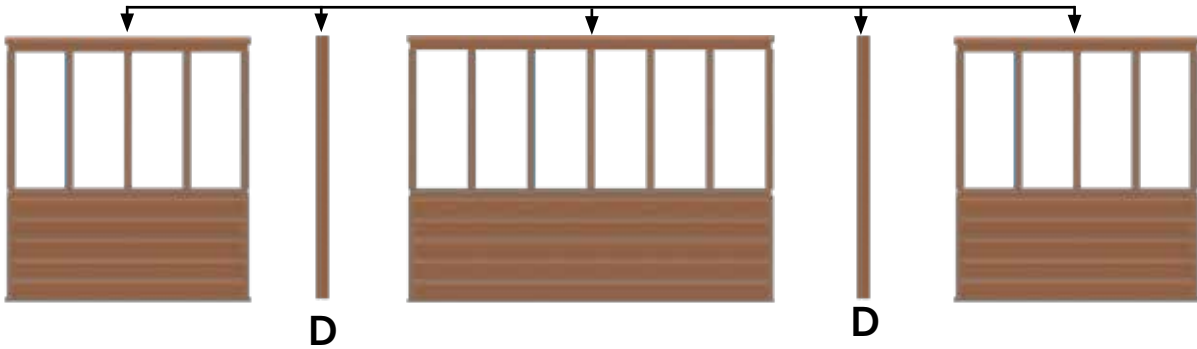

15 PANEL

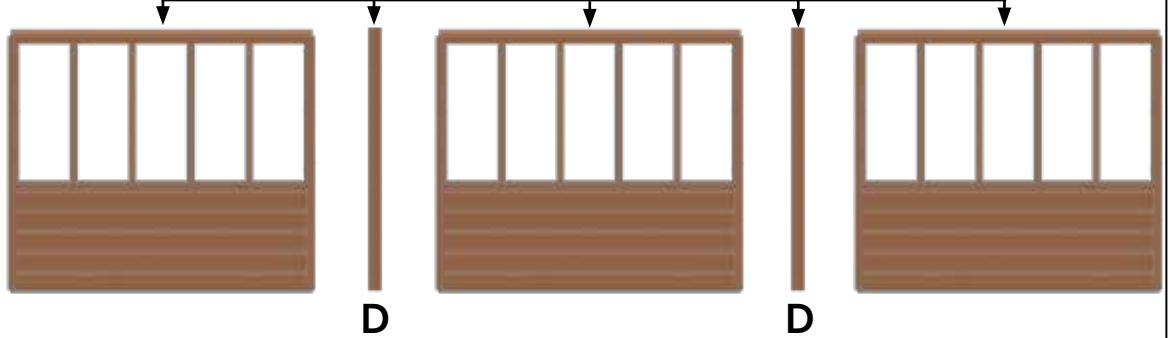

16 PANEL

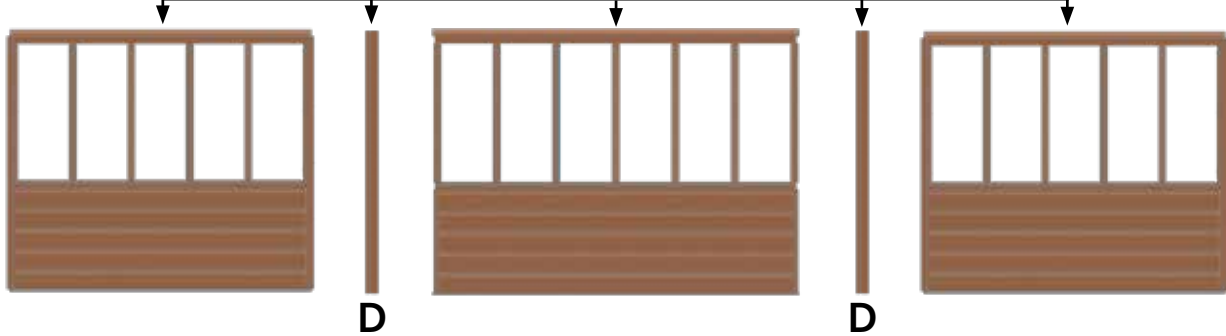

	#	mm
	D W135	-

2.3

17 PANEL

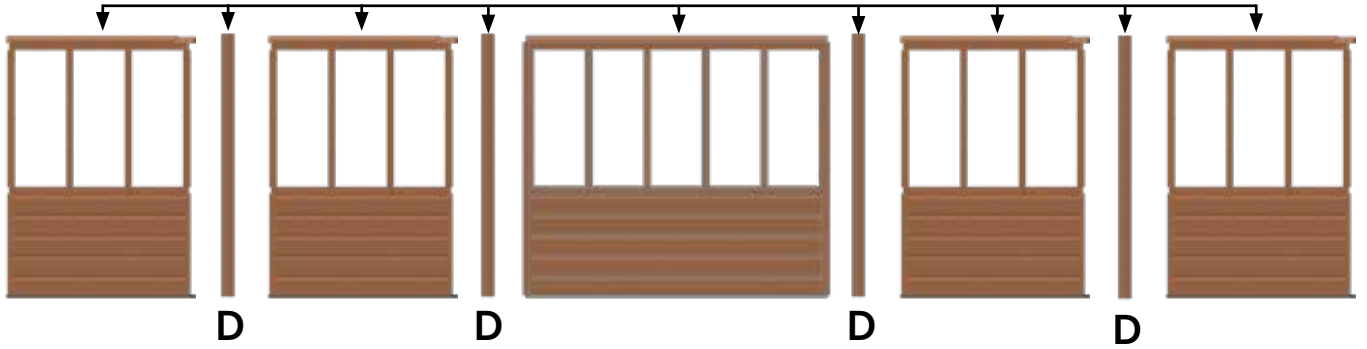

18 PANEL

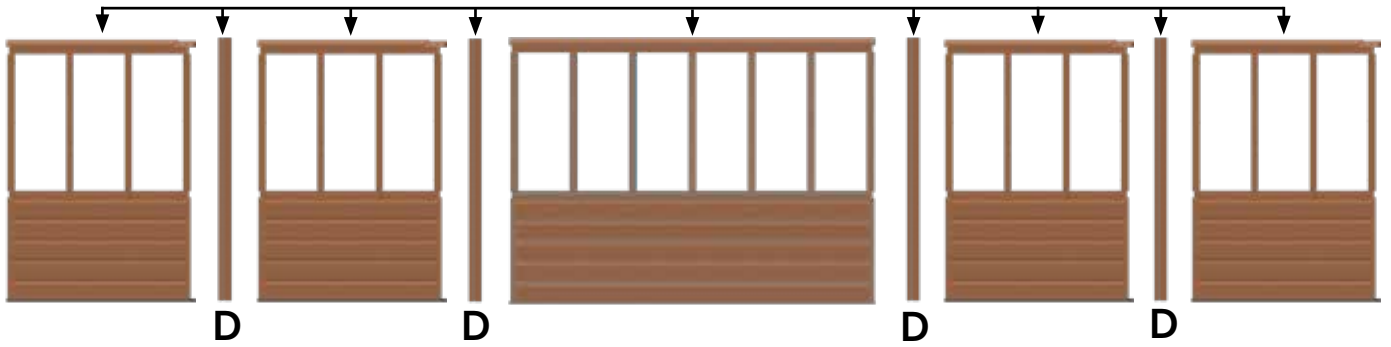

19 PANEL

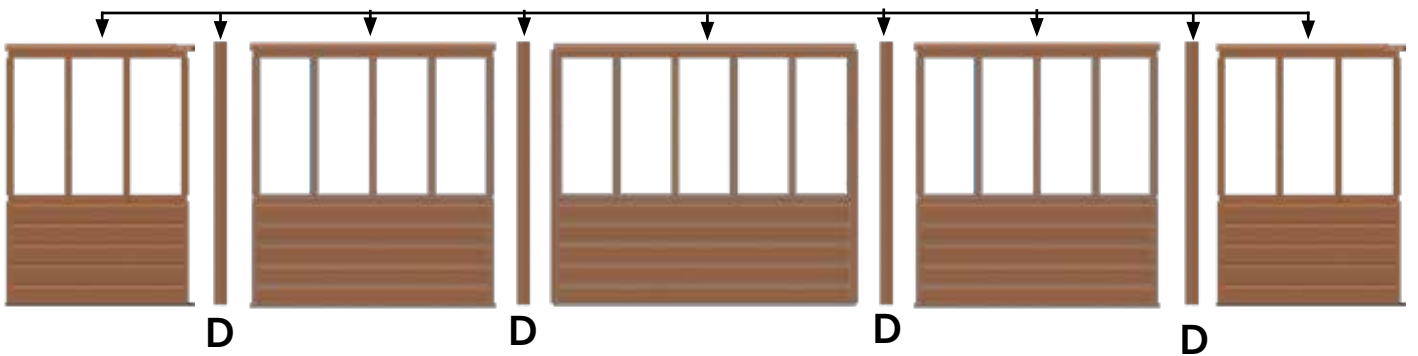

20 PANEL

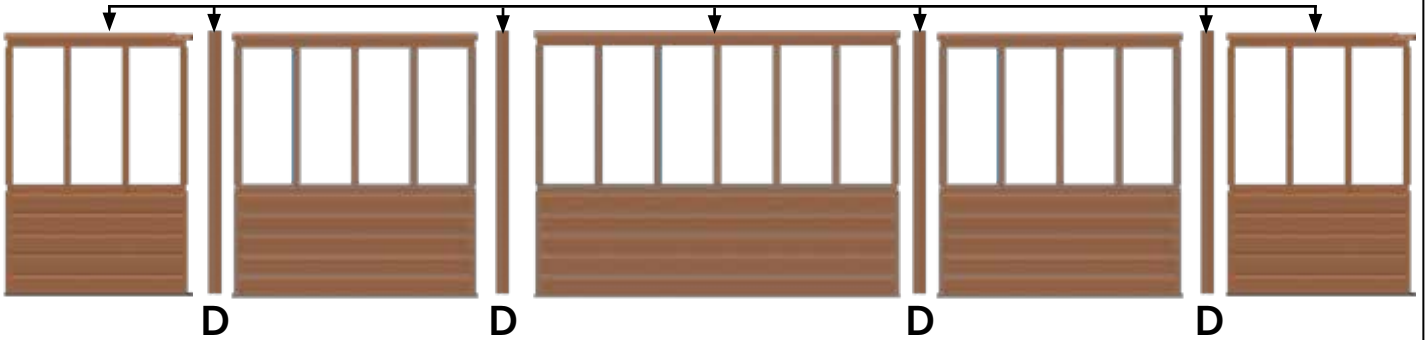

	#	mm
	D W135	-

(Planthouse Variant Example) Assemble - Samilng - Verbinden - Montera - Assemblage - Monteren - kokoaminen - Montaž stelaža - Montere - Armar

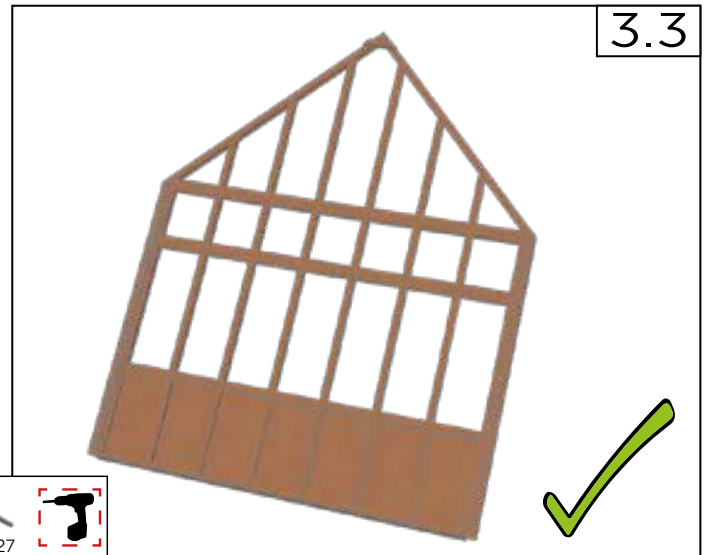
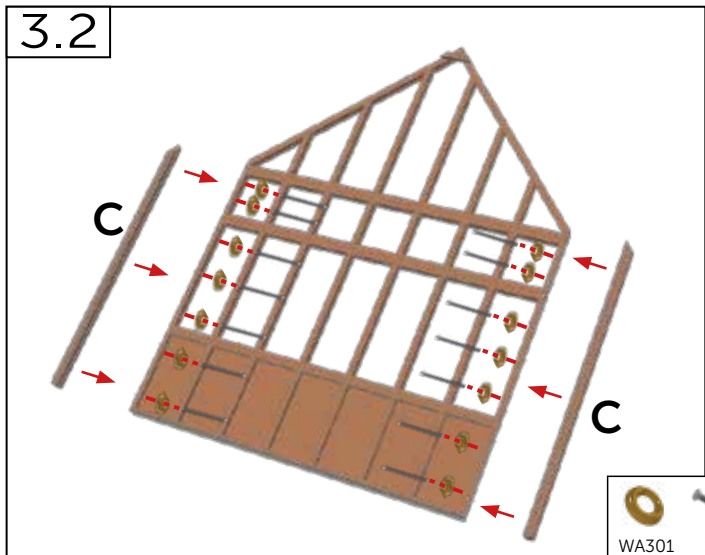
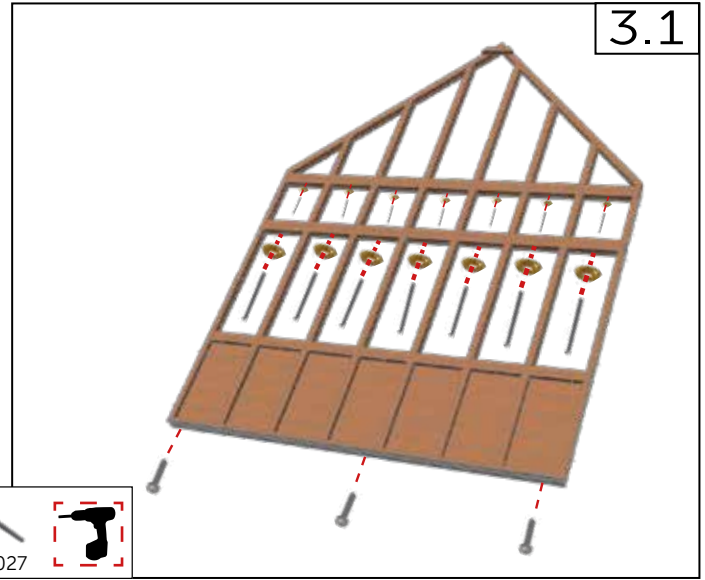
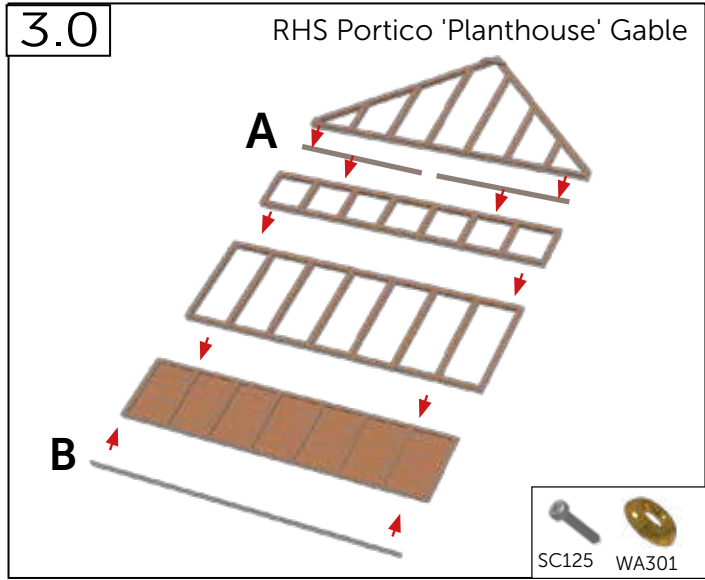

	#	mm
	SC027	4.2 x 65
	SC301	No. 8
	A	W900
	B	AL2004
	SC125	4.2 x 25
	C	W165
	D	W165

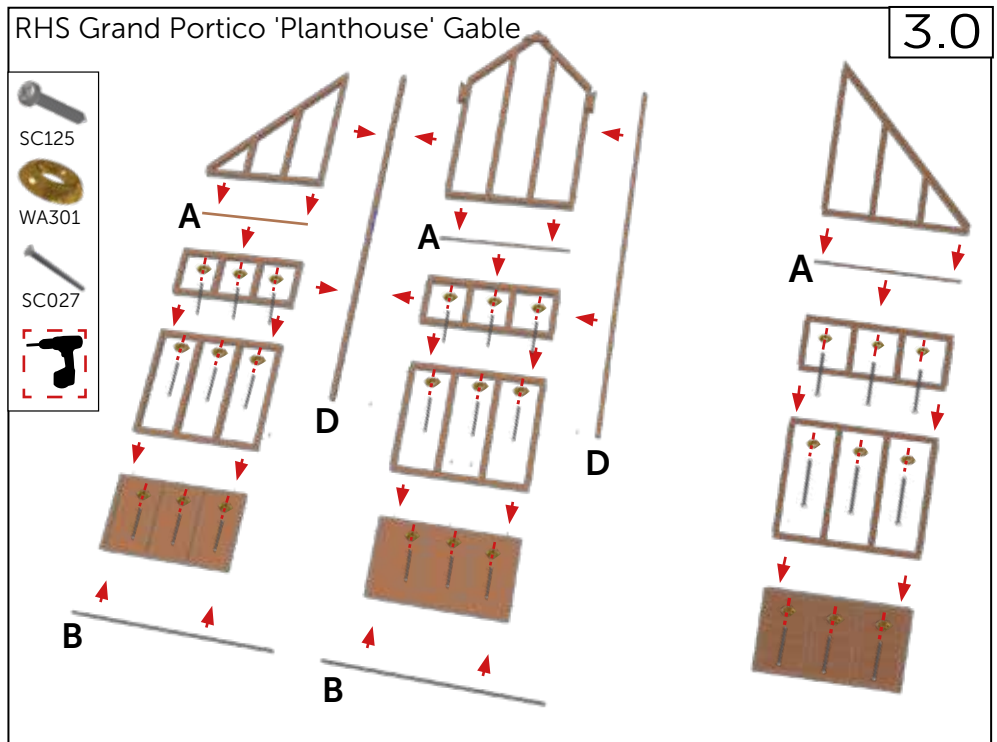

(Planthouse Variant Example) Assemble - Samling - Verbinden - Montera - Assemblage - Monteren - kokoaminen - Montaż stelaża - Montere - Armar

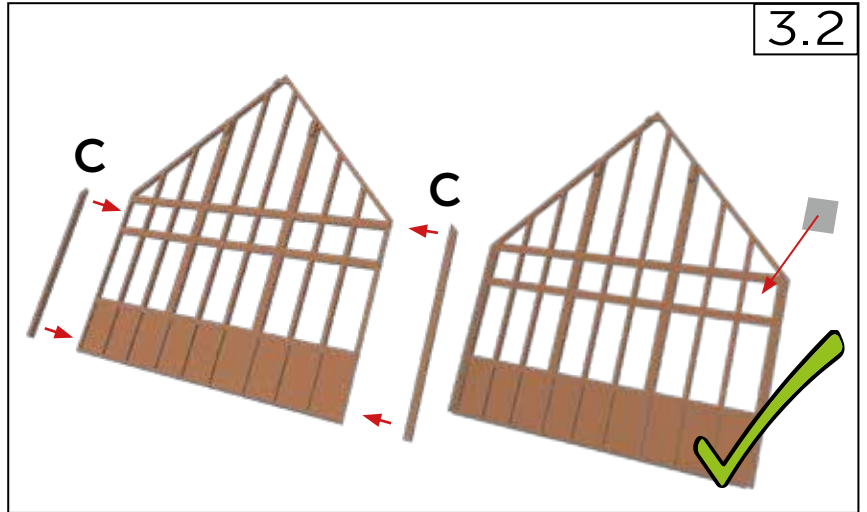
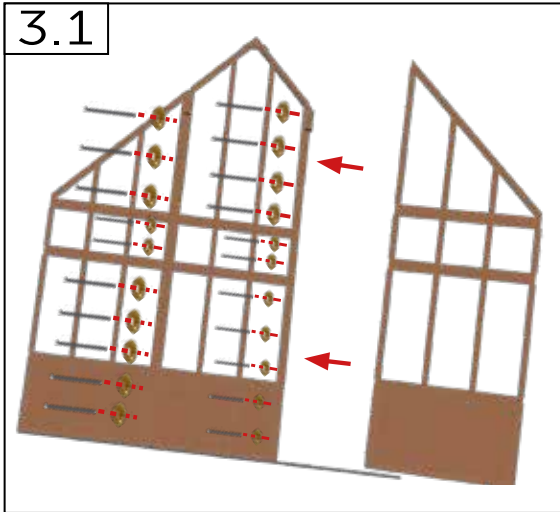

	#	mm
	SC027	4.2 x 65
	SC301	No. 8
	E W130	-
	A W900	-
	D W135	-
	B AL2004	-
	SC125	4.2 x 25

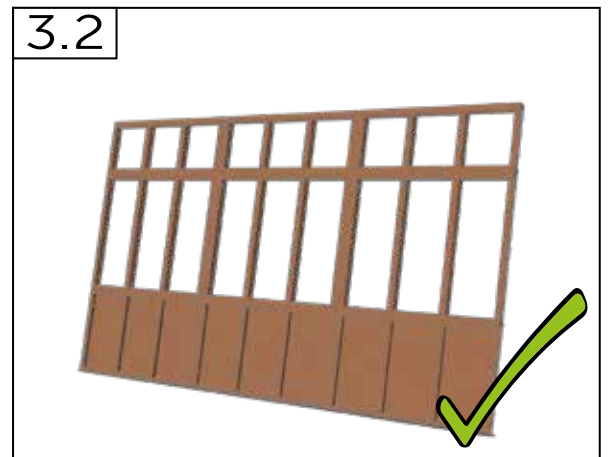
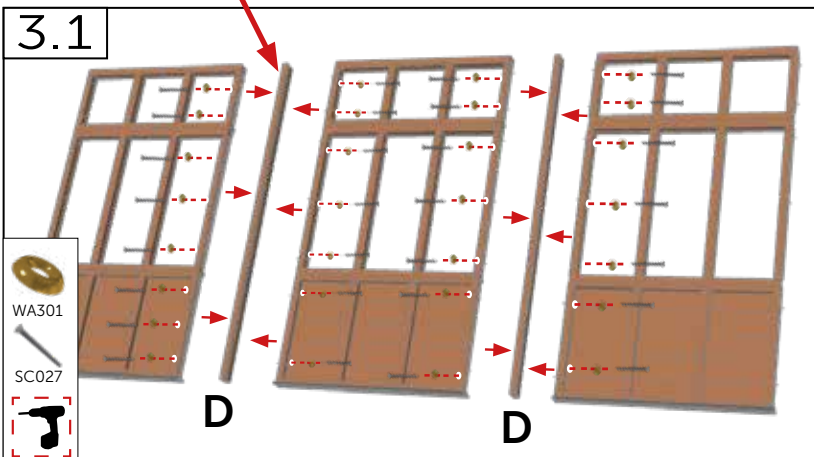
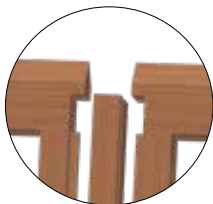
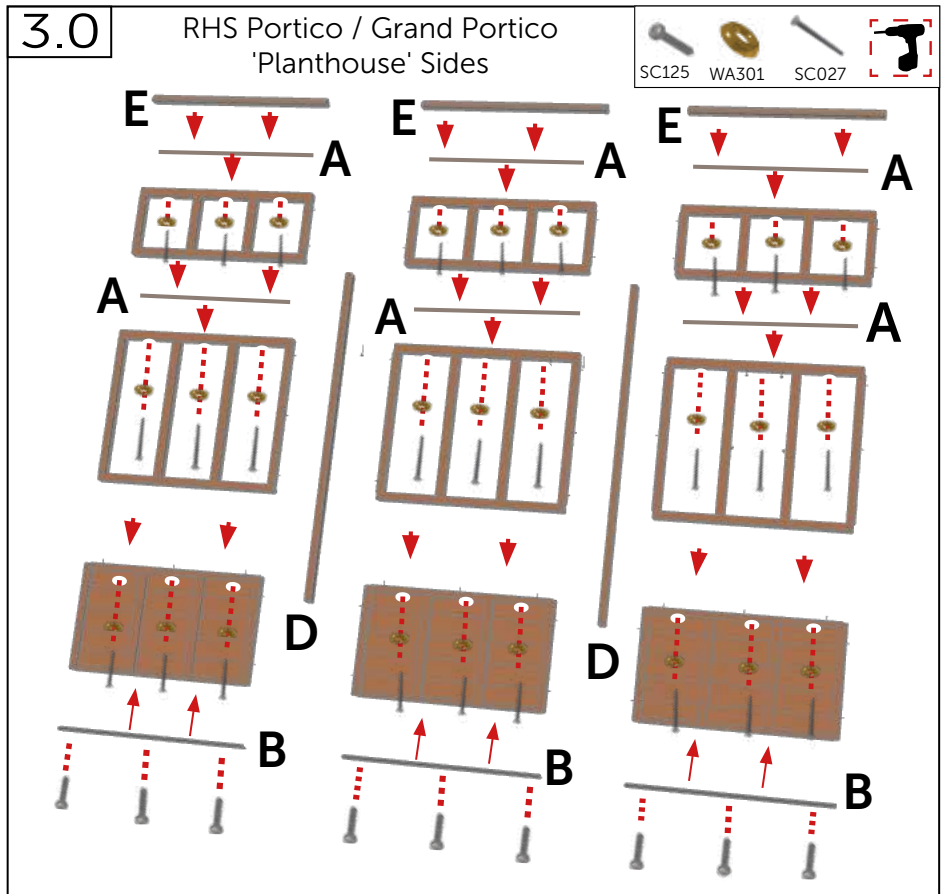

3.0

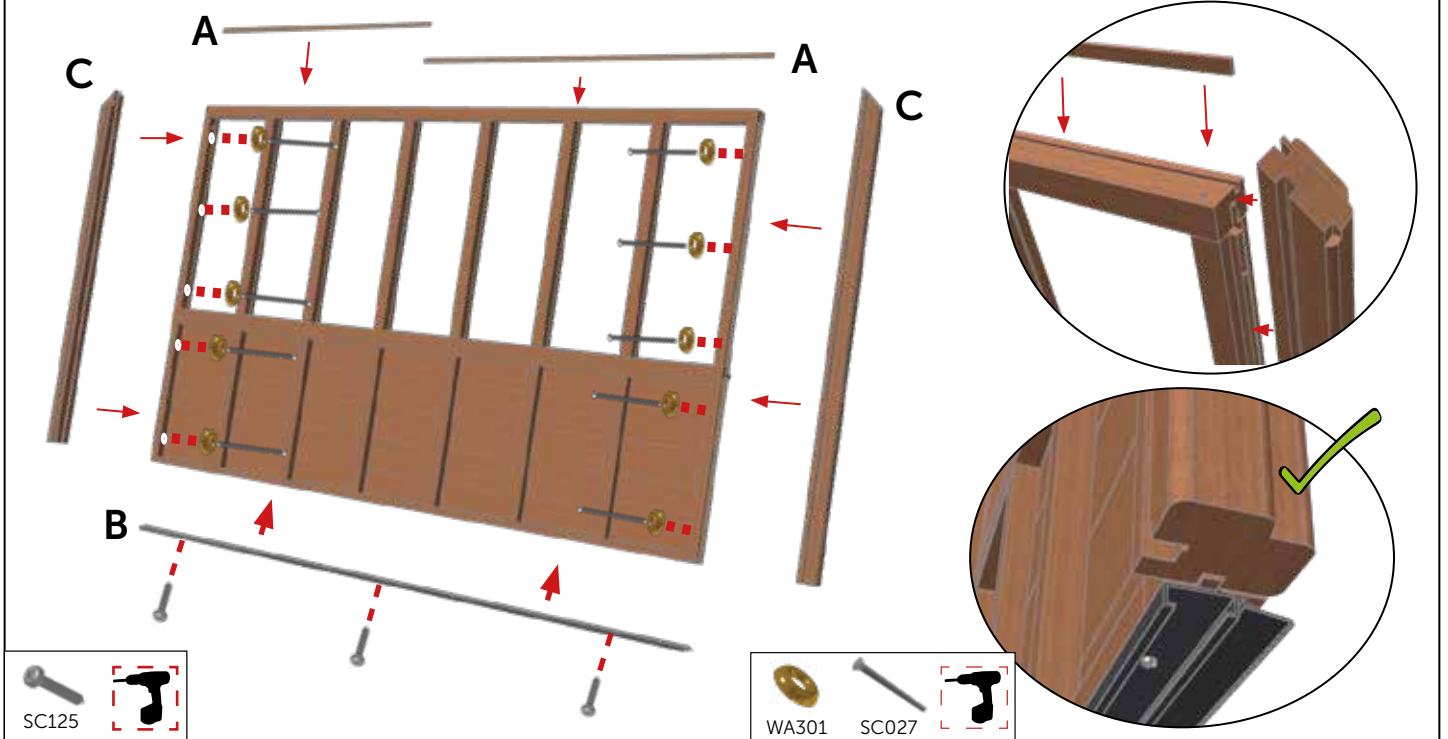

3.1

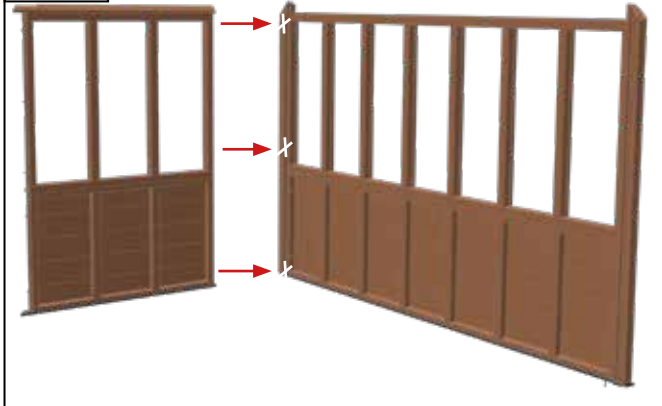

3.2

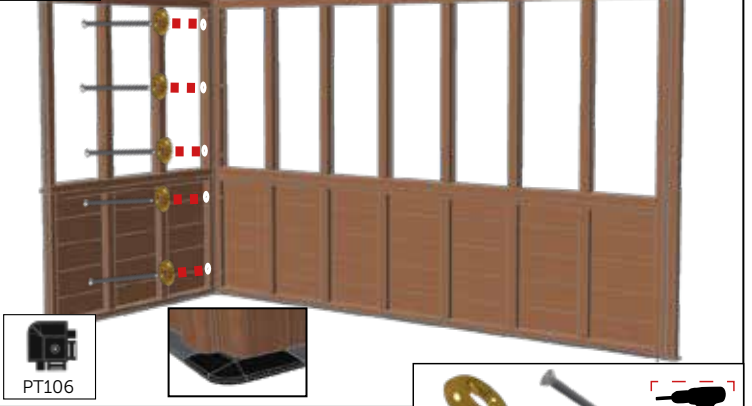

	#	mm
	PT106	-
	SC027	4.2 x 65
	WA301	No. 8
	A W900	-
	B AL2004	-
	C W165	-

3.3

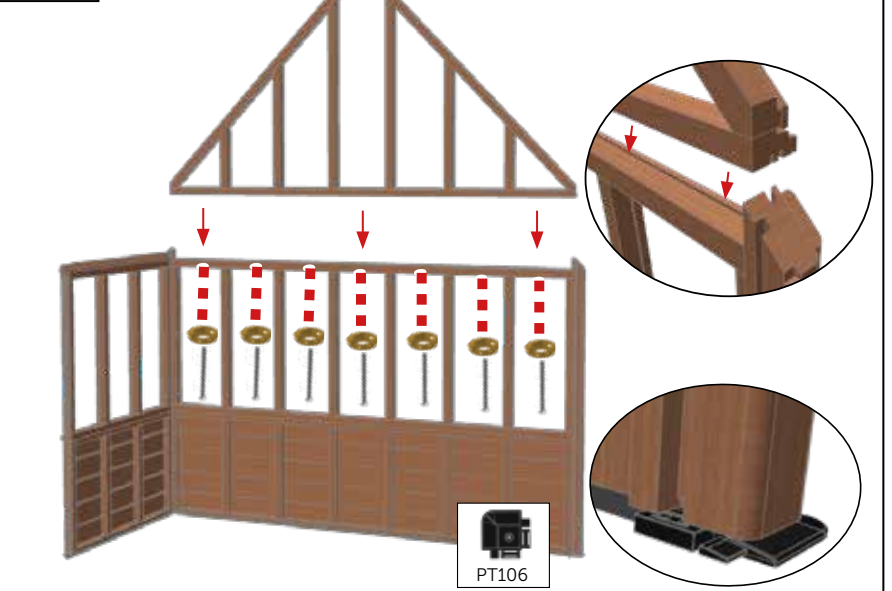

Assemble - Samling - Verbinden - Montera - Assemblage - Monteren - kokoaminen - Montaż stelaża - Montere - Armar

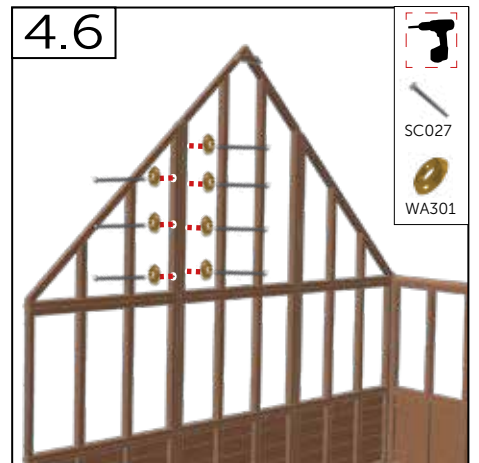
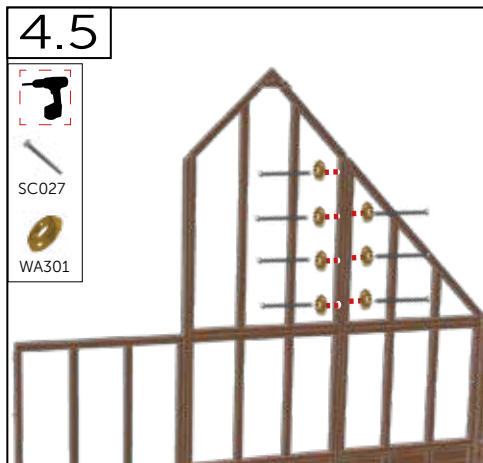
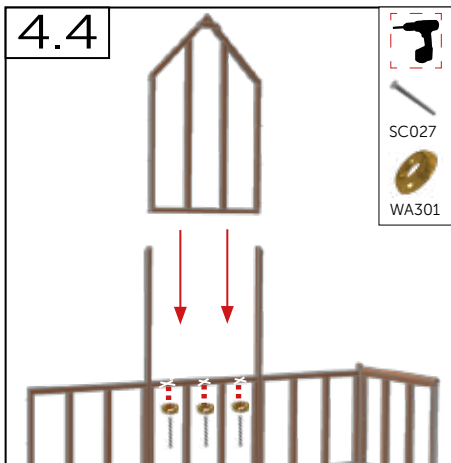
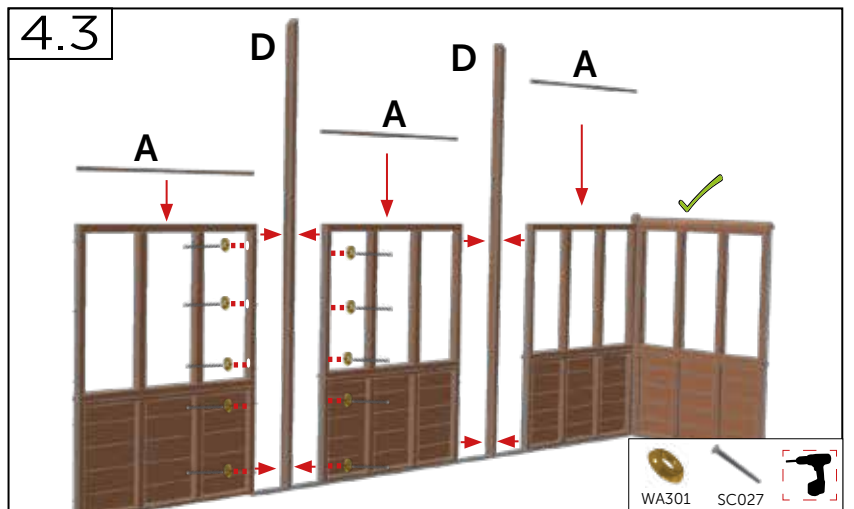
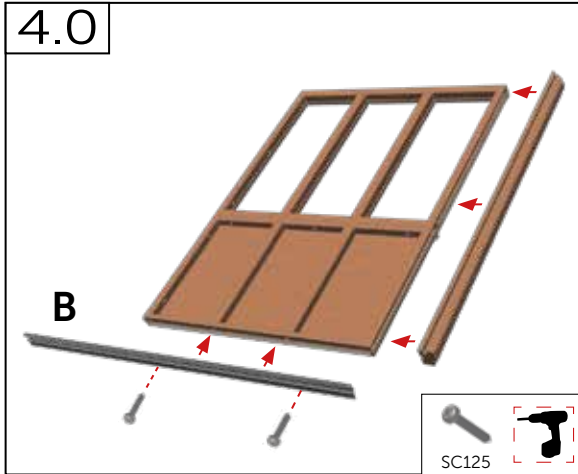

	#	mm
	PT106	-
	SC027	4.2 x 65
	WA301	No. 8
	A	W900
	D	W135
	B	AL2004

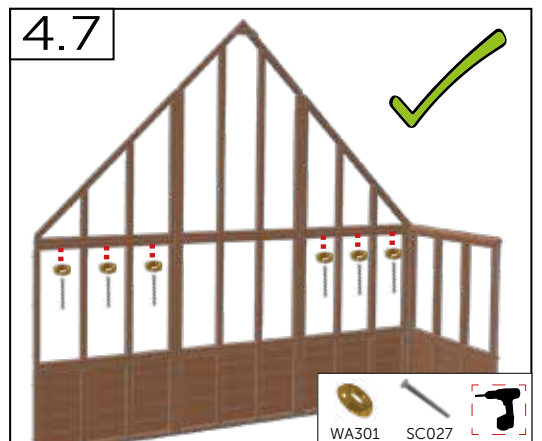
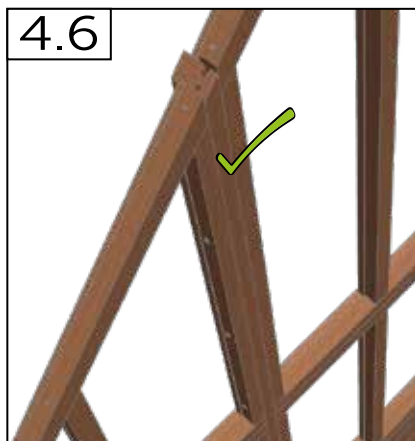



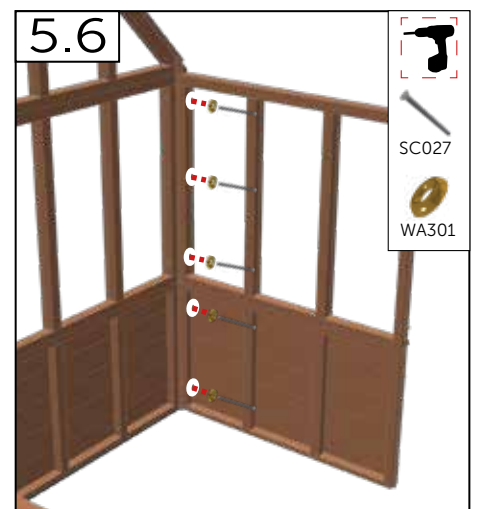
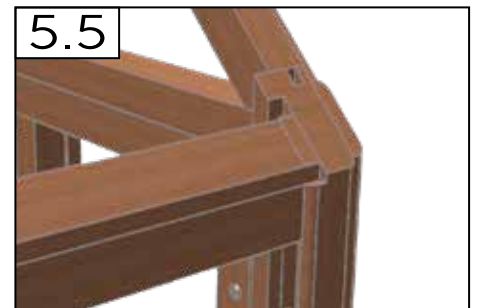
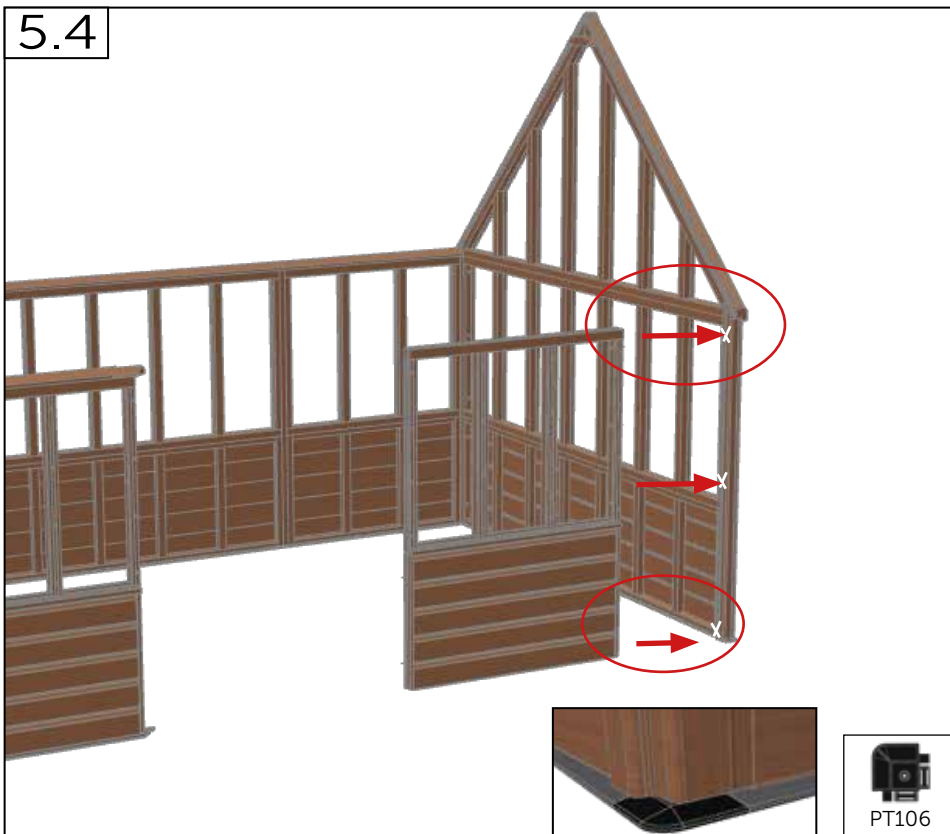
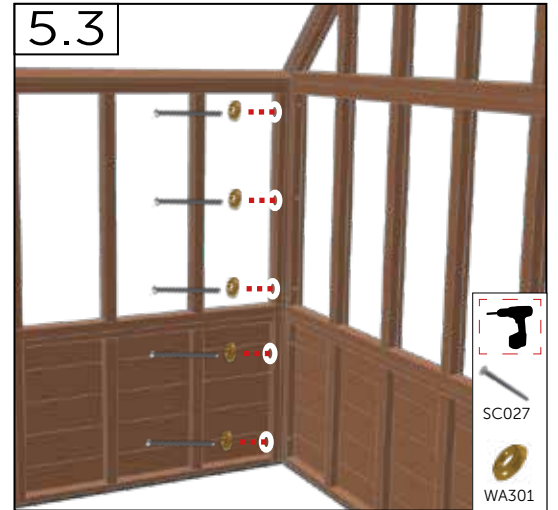
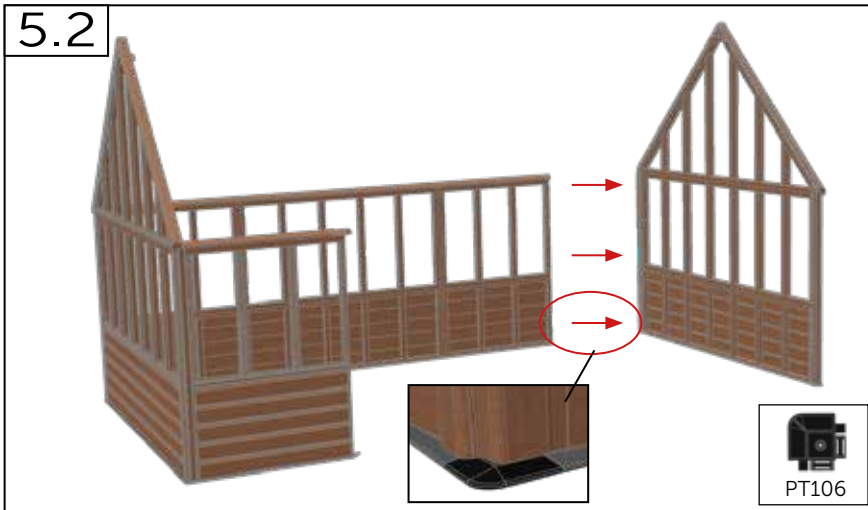
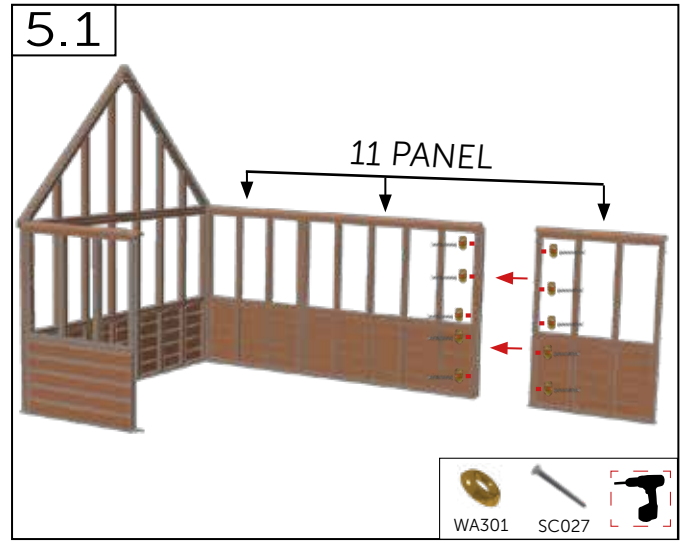
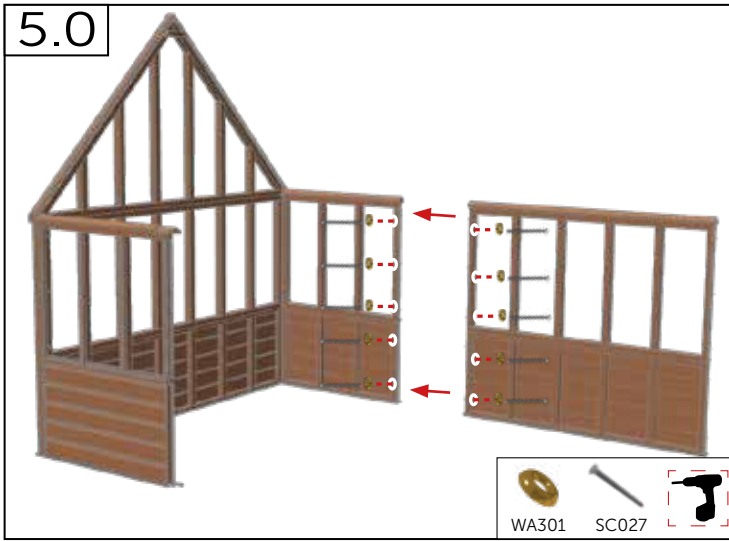

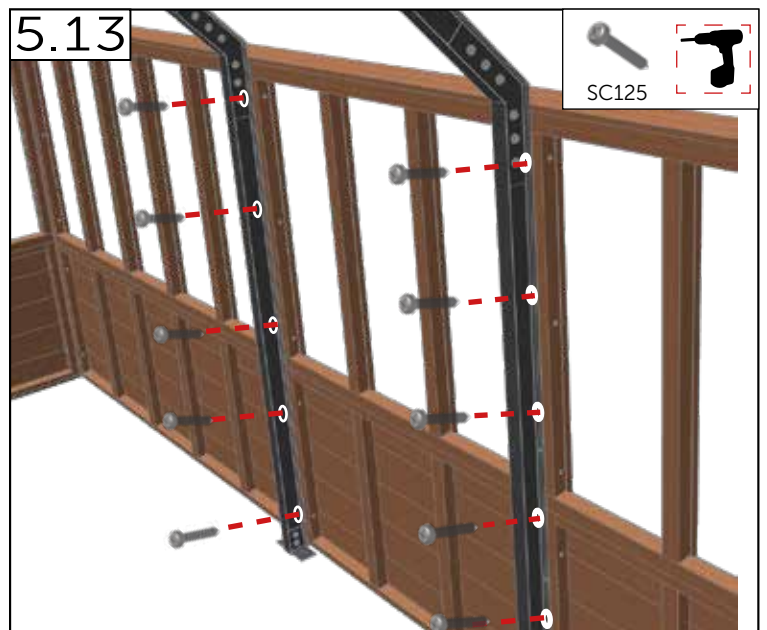
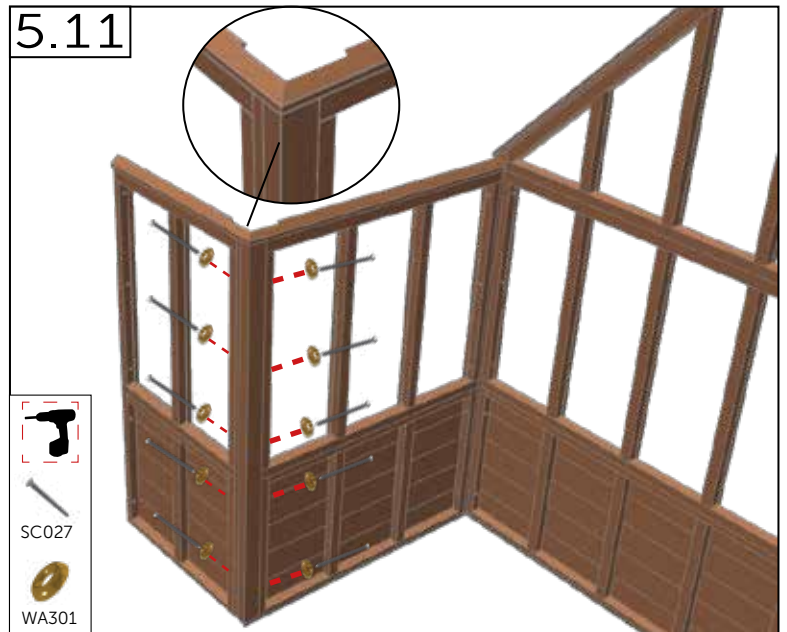
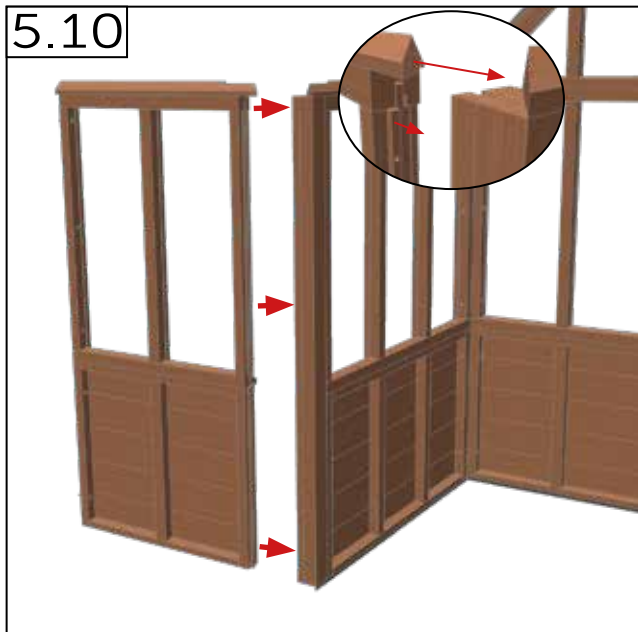
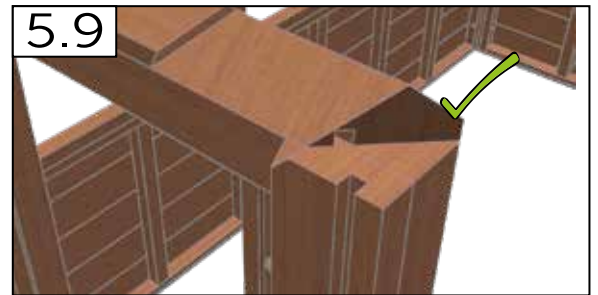
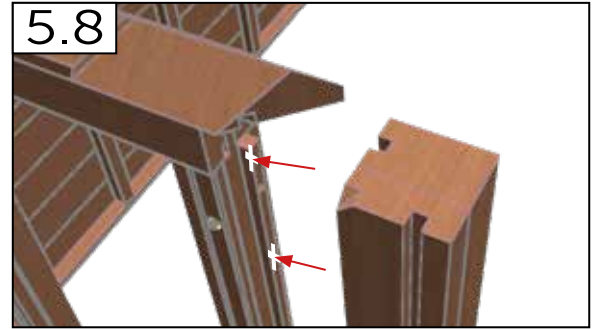
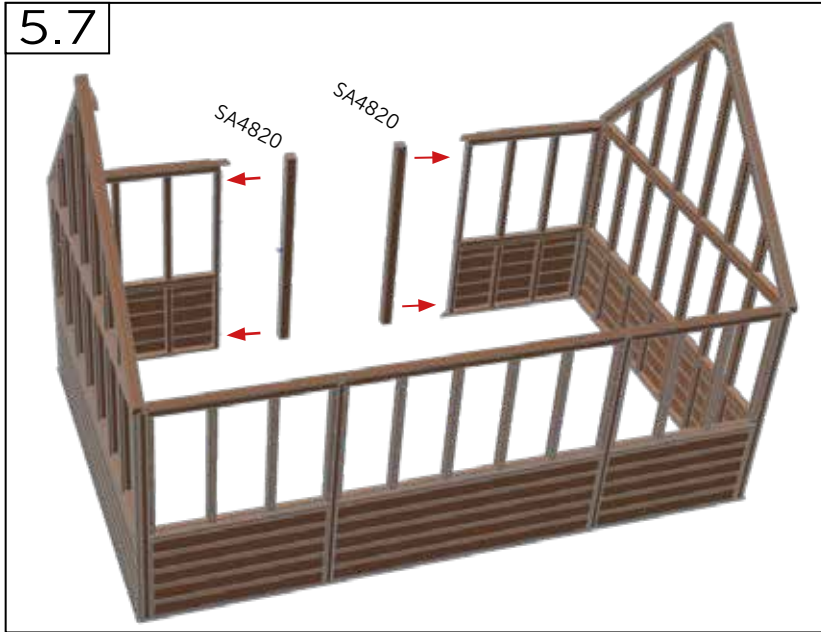

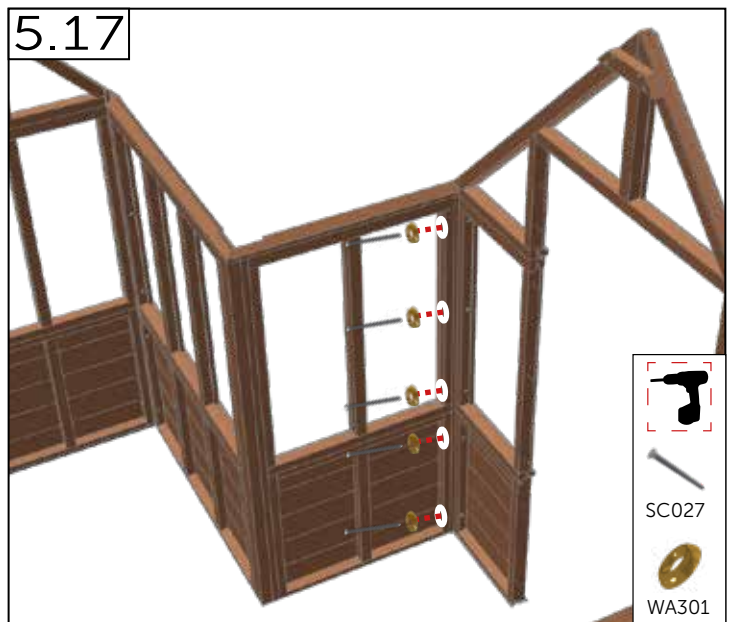
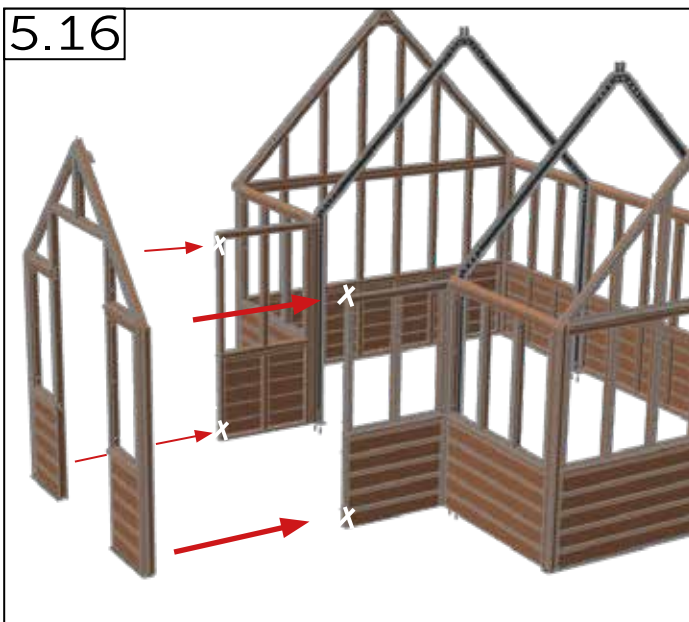
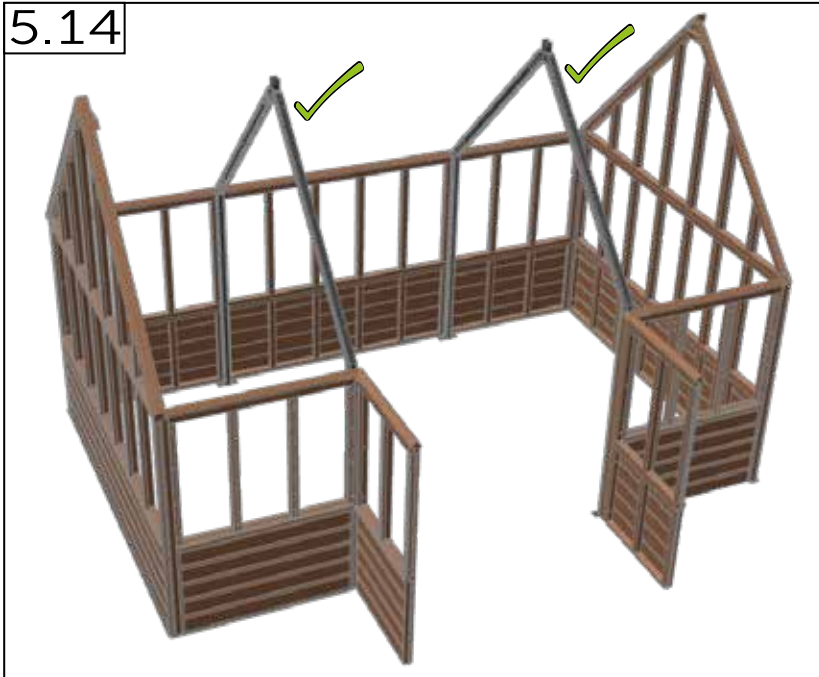

	#	mm
	Portal	-
	SC027	4.2 x 65
	WA301	No. 8

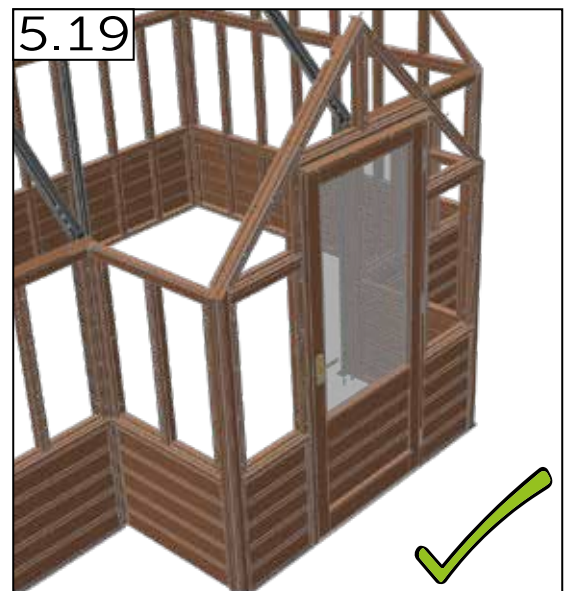

6.0



	#	mm
	A	-
	B	-
	AD001	70
	BL155	M8 x 70
	BL156	M8 x 80
	WA205	M8
	NU101	M6
	AL3076	-
	SC125	4.2 x 25

6.1

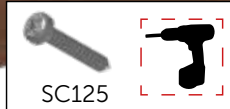
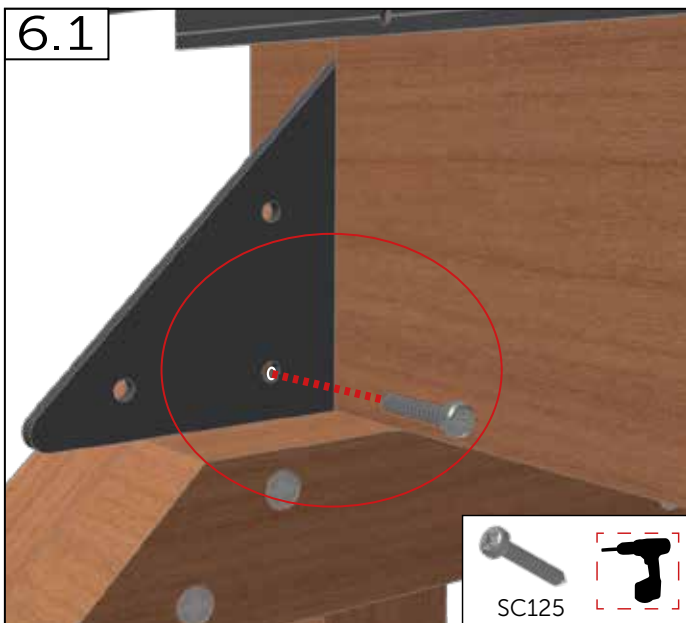

6.2

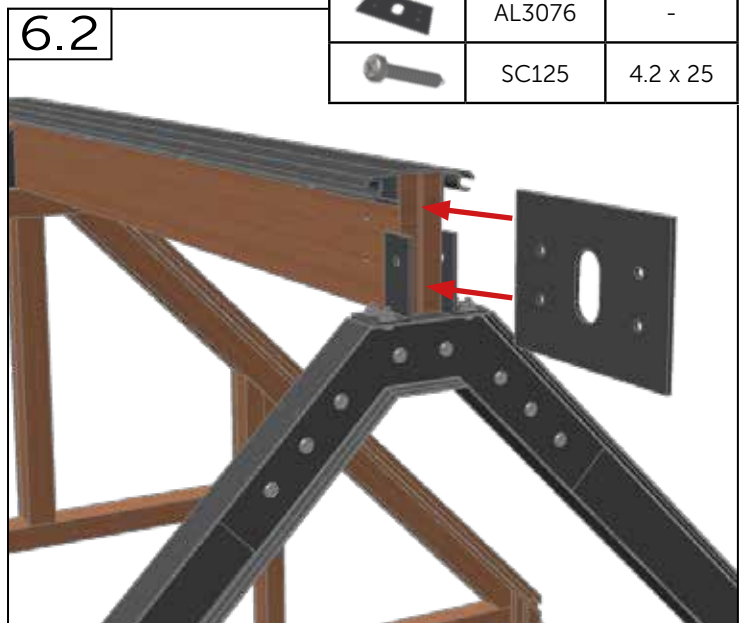

6.3



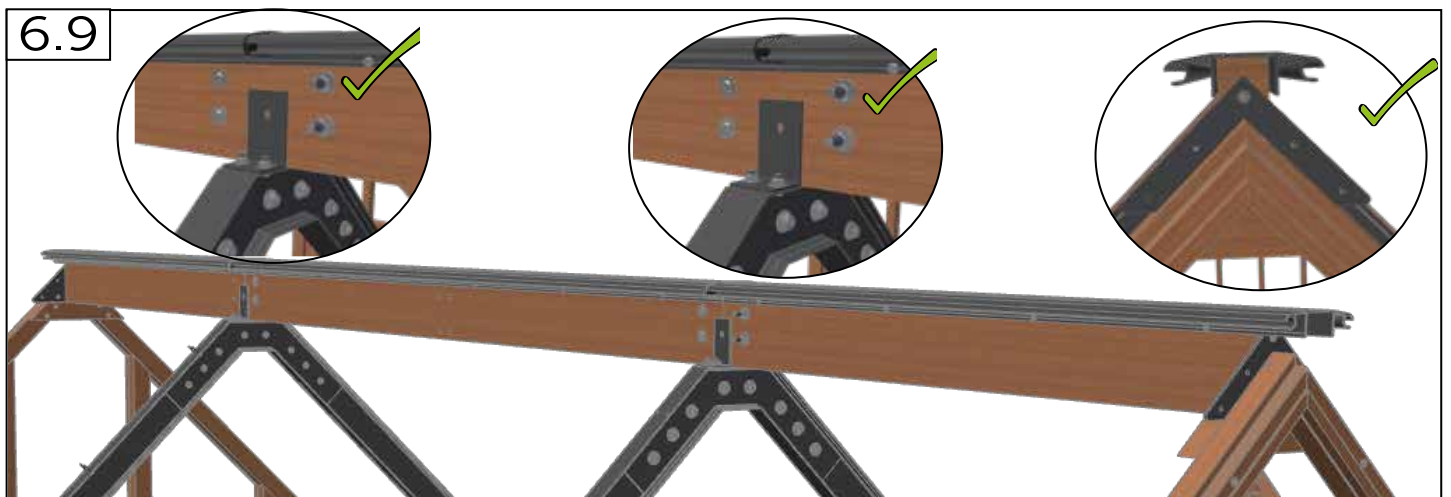
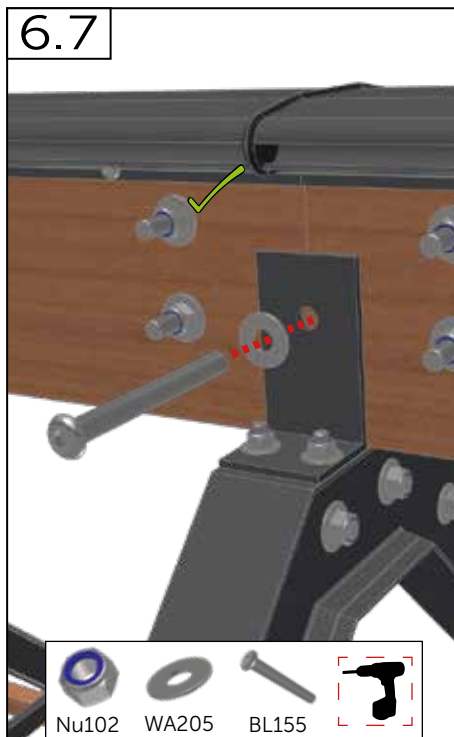
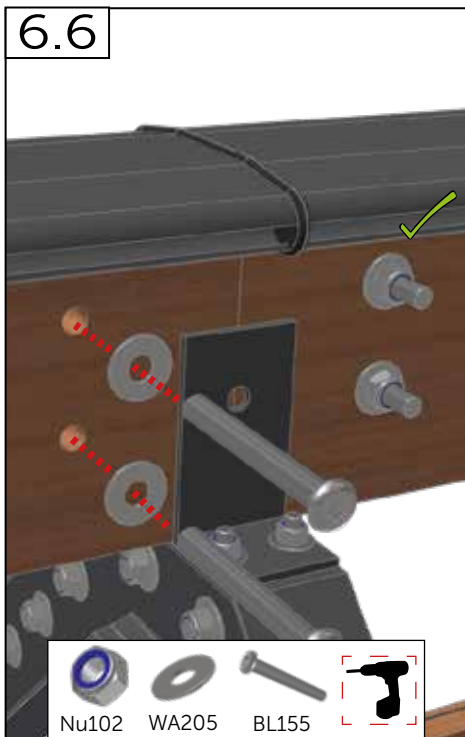
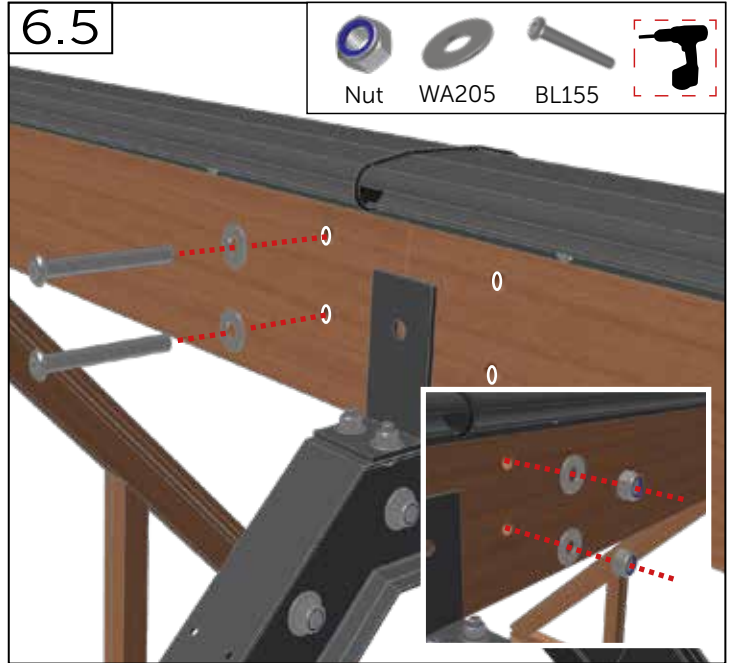
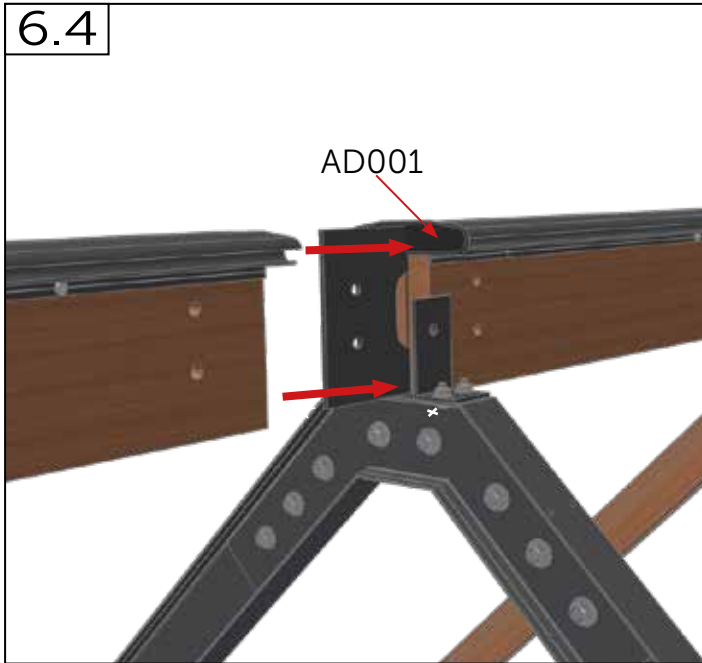

Assemble - Samilng - Verbinden - Montera - Assemblage - Monteren -  
 kokoaminen - Montaż stelaża - Montere - Armar

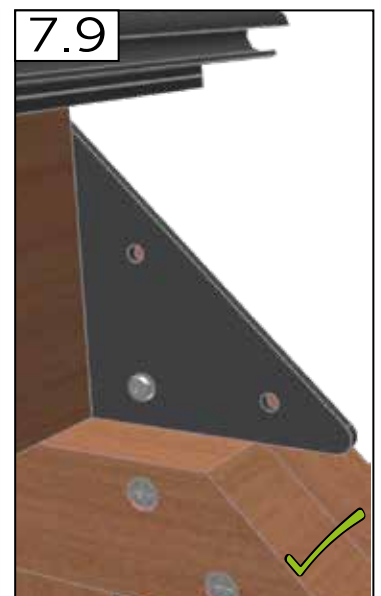
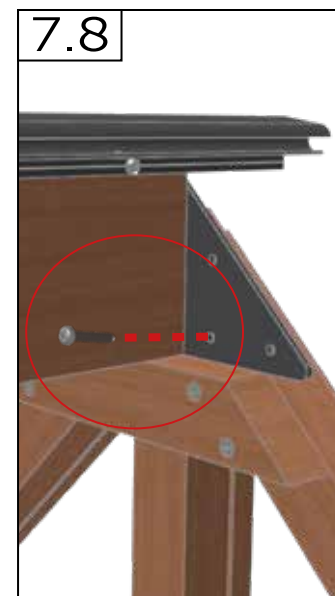
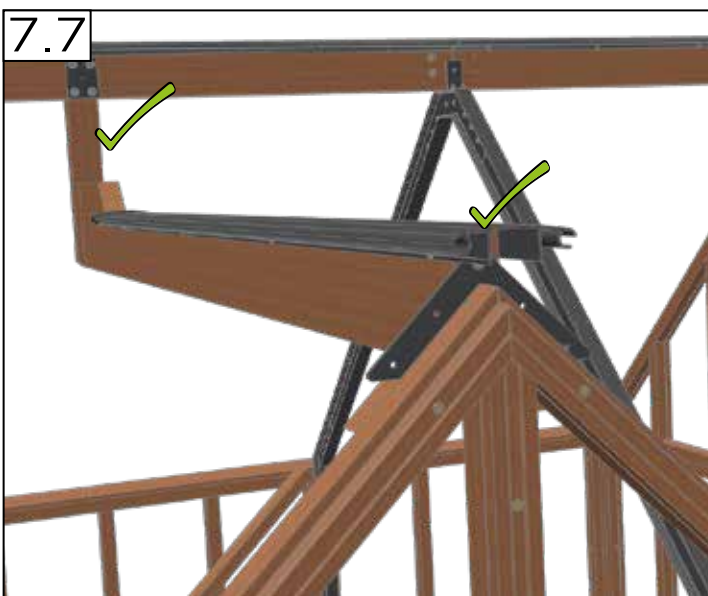
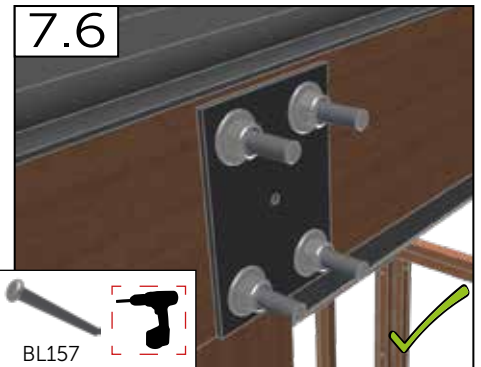
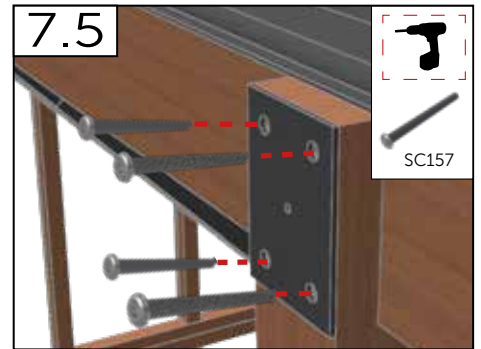
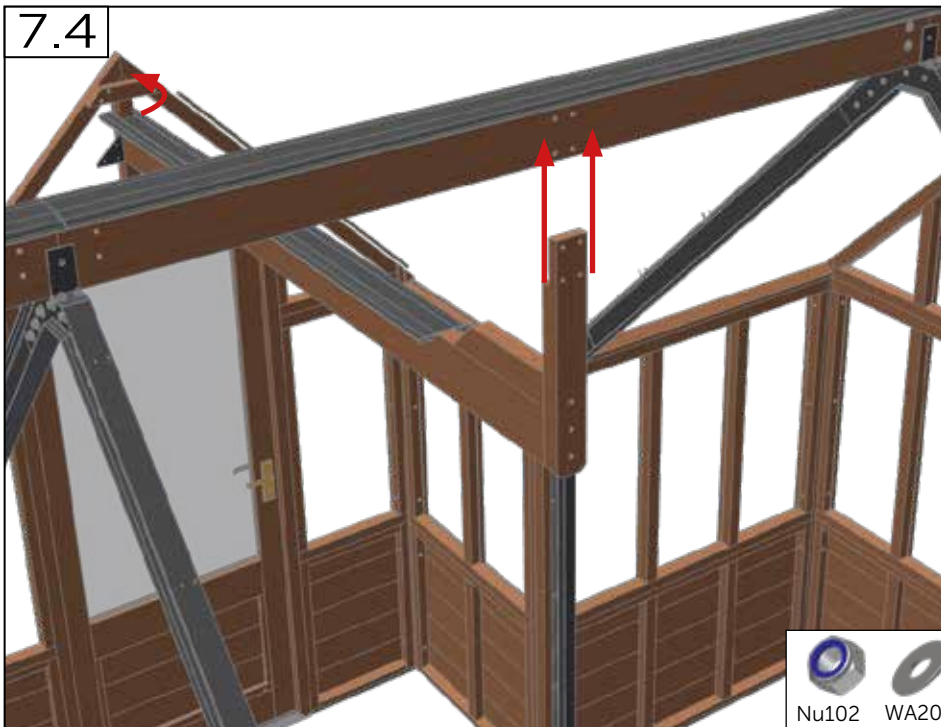
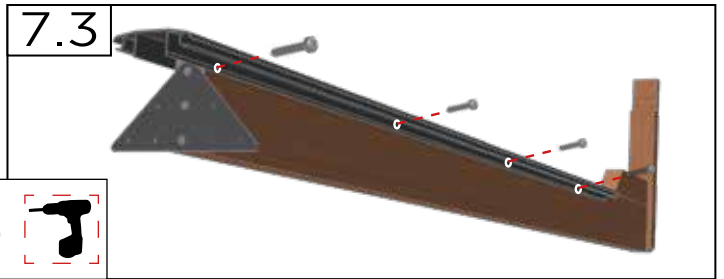
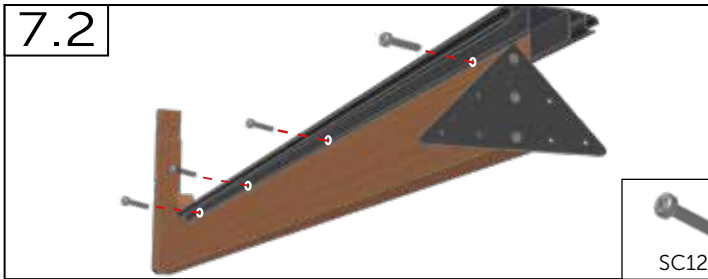
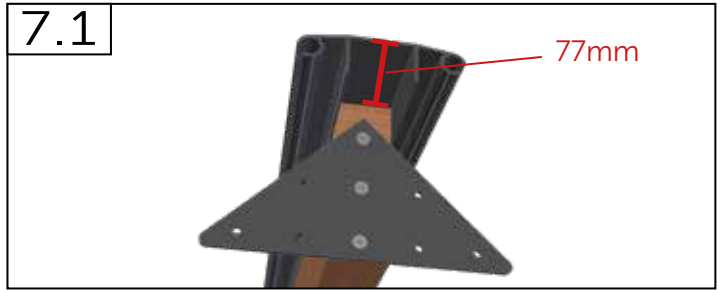
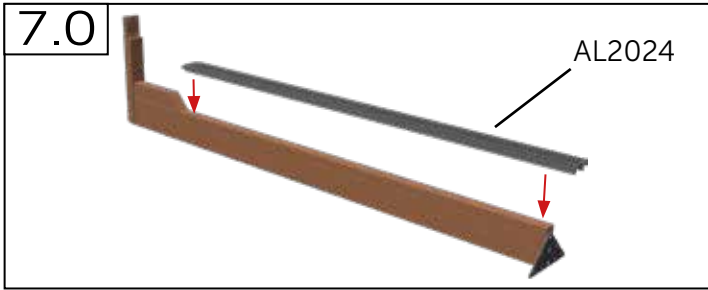

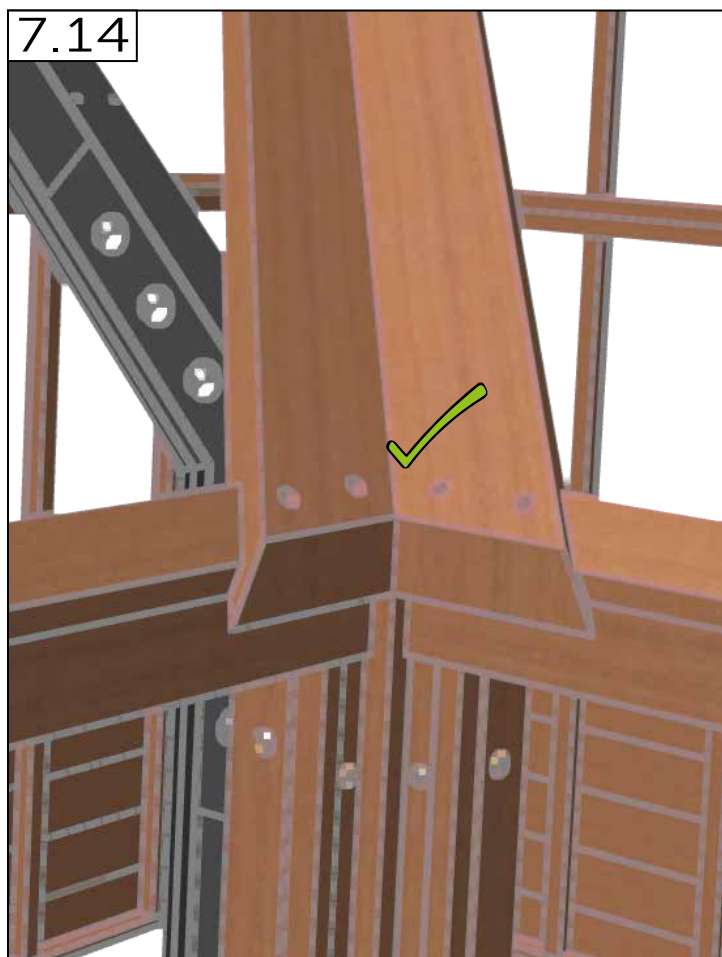
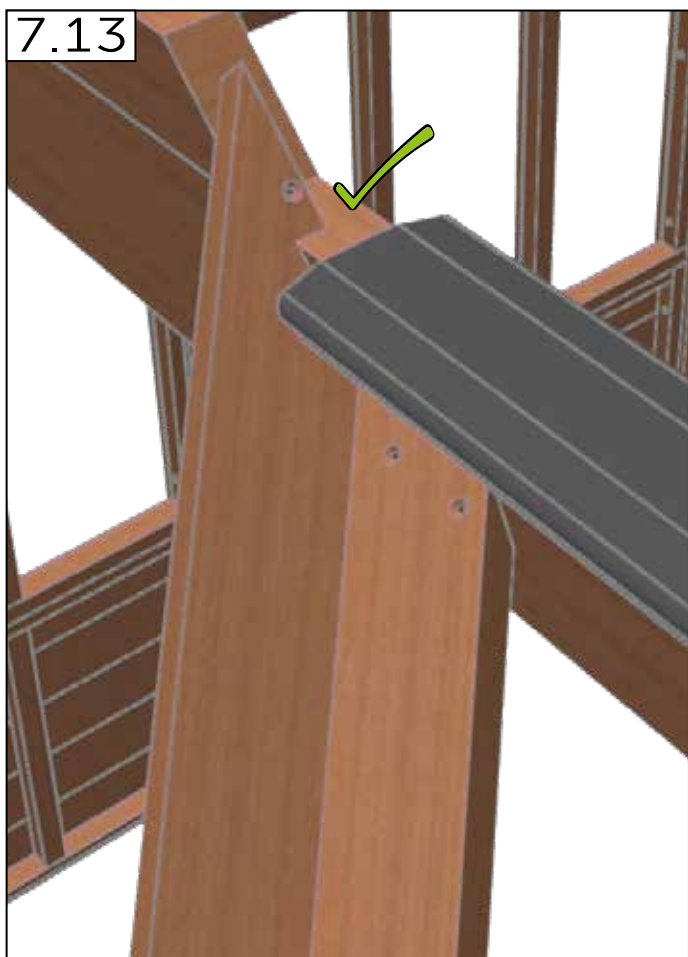
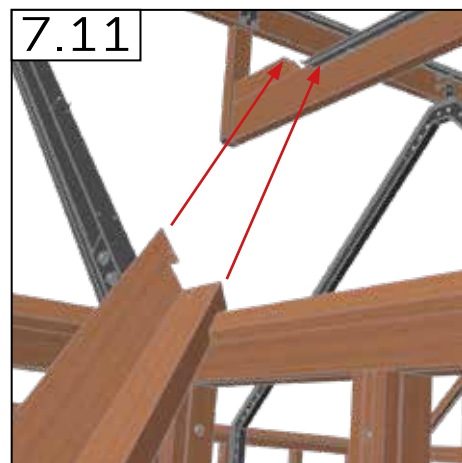
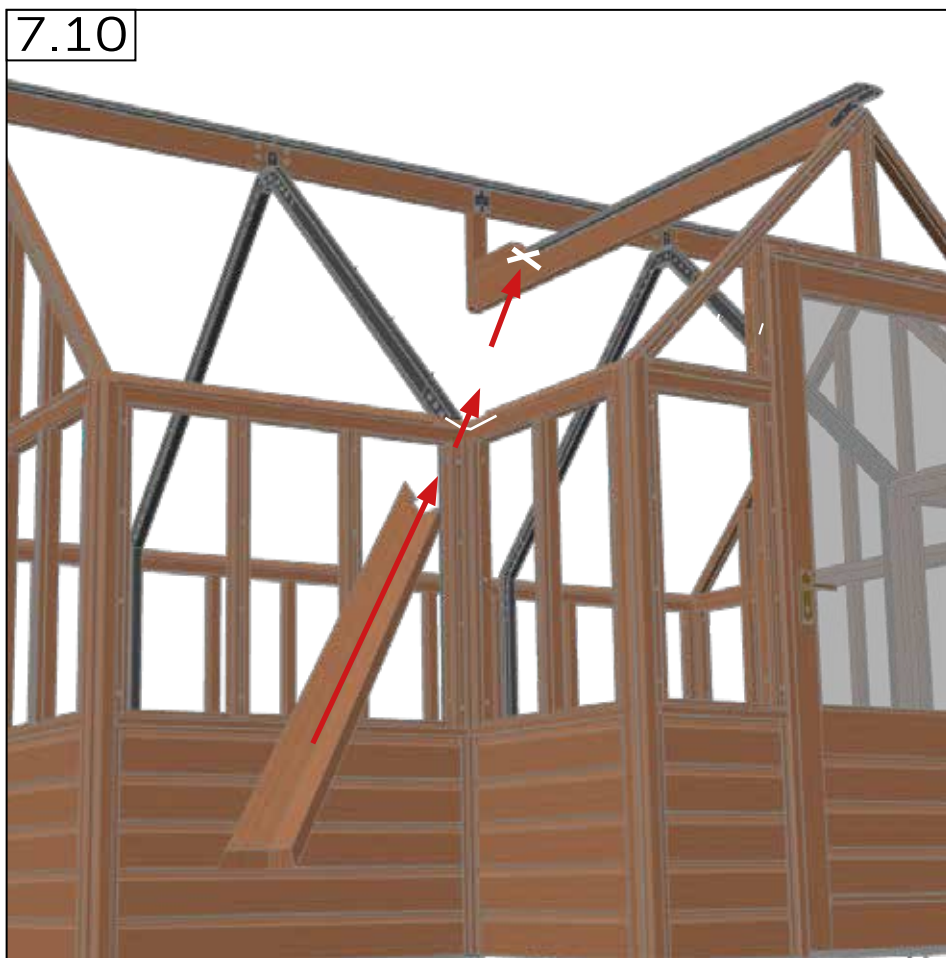

8.0

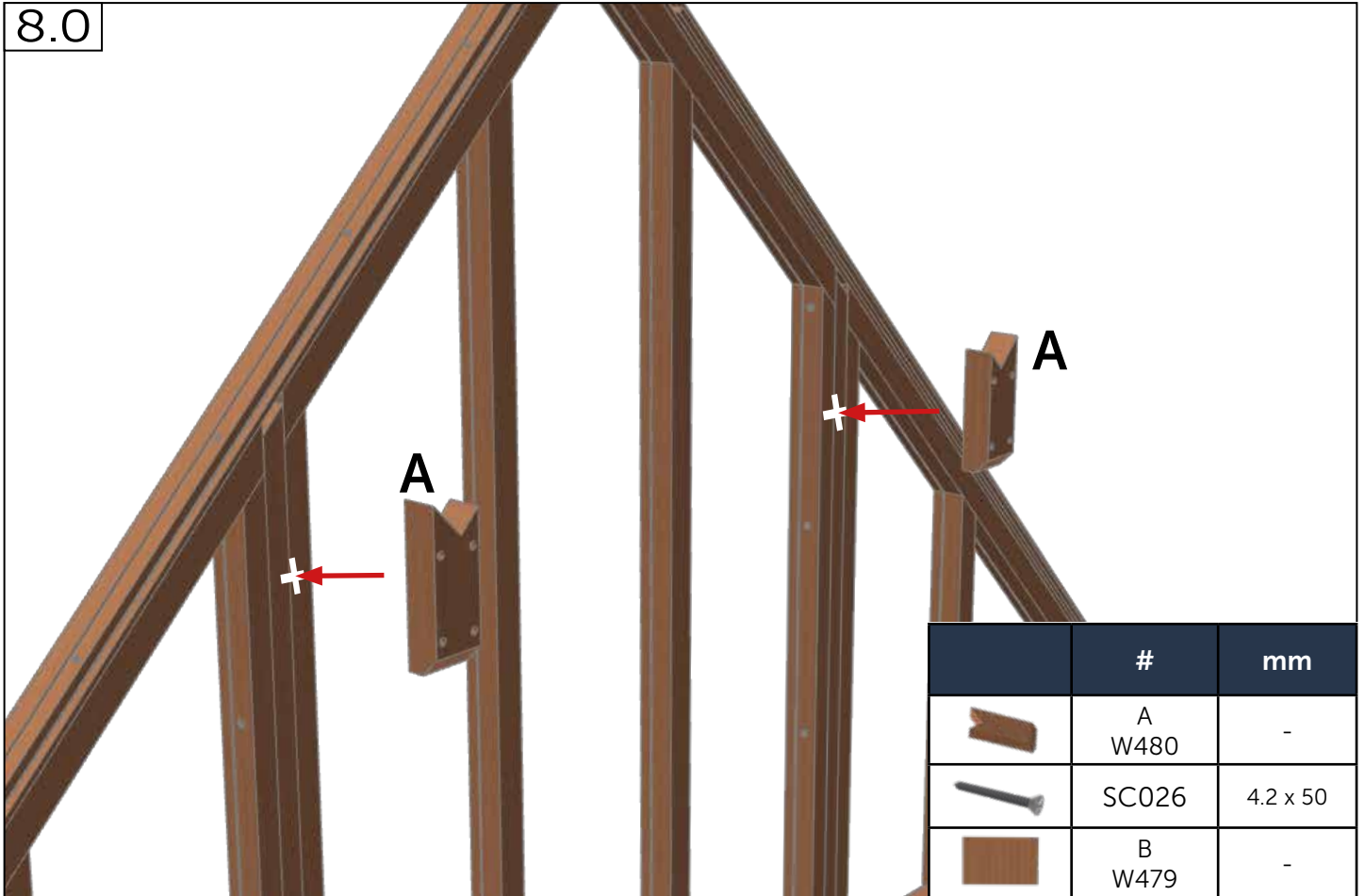

8.1

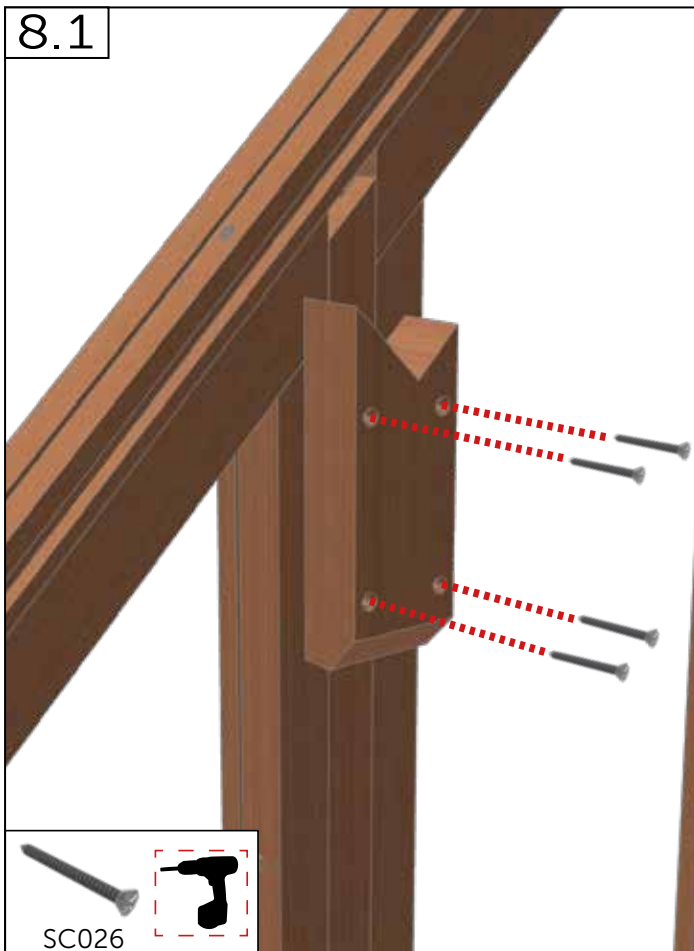

8.2

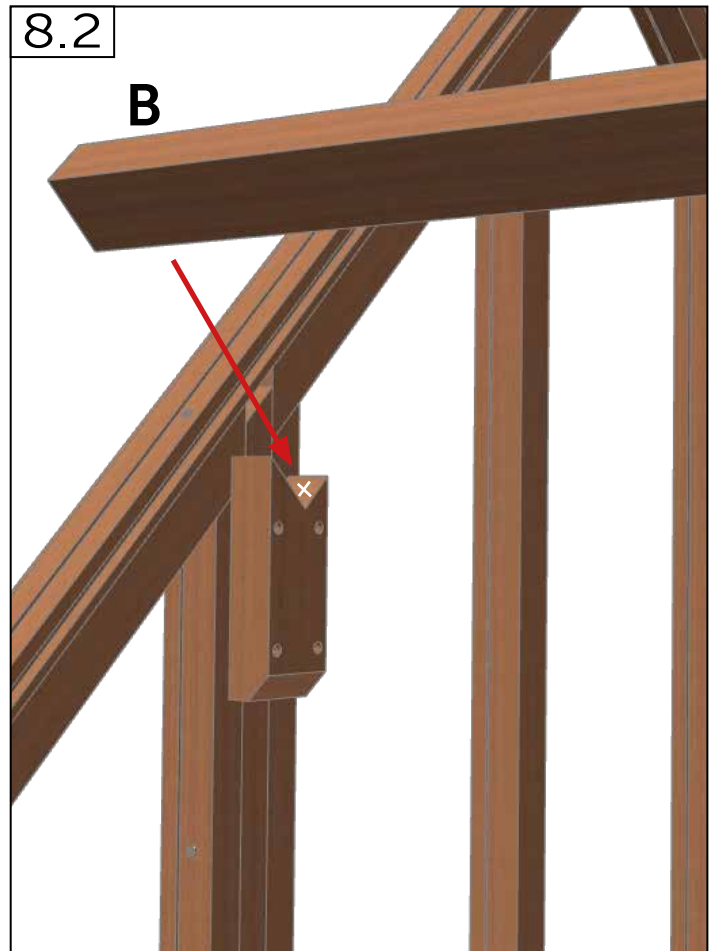



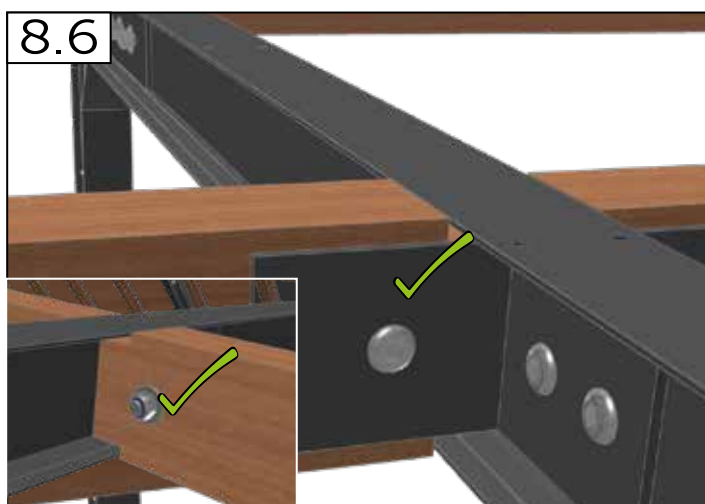
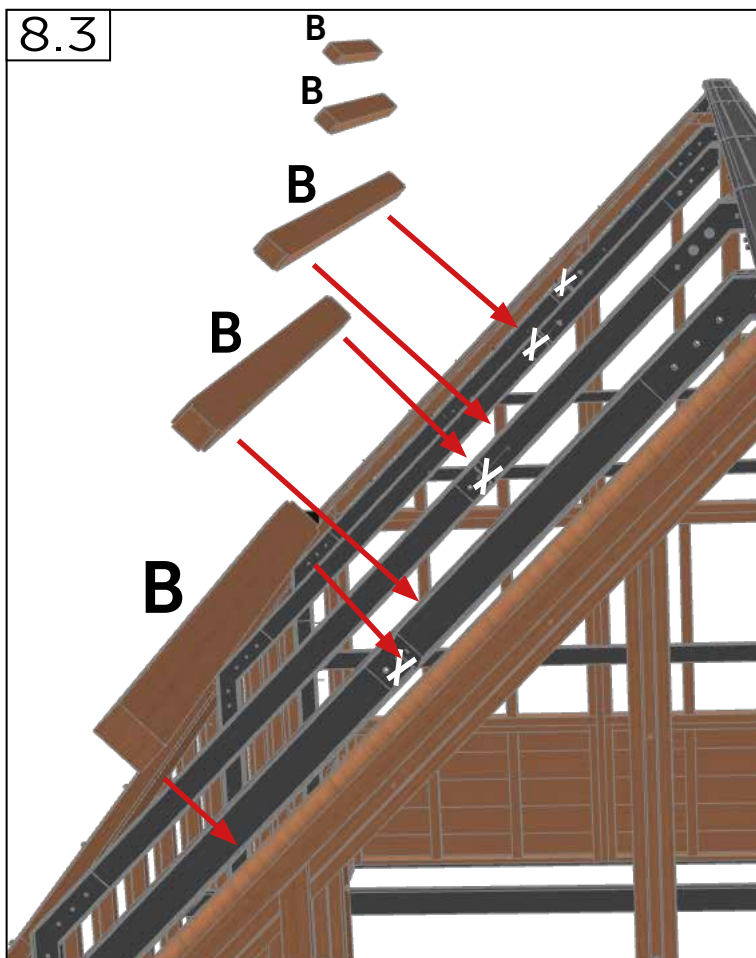

	#	mm
	B W479	-
	SC156	M8 x 80
	NU101	M6
	WA205	M8

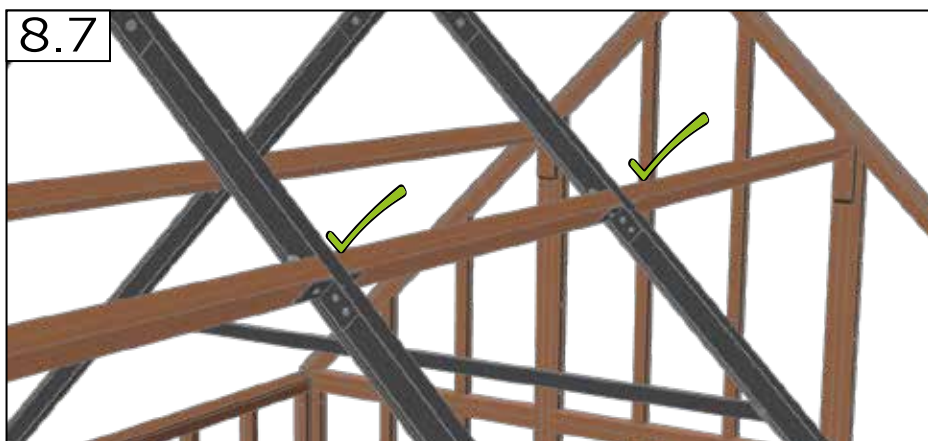

9.0

# RHS Portico

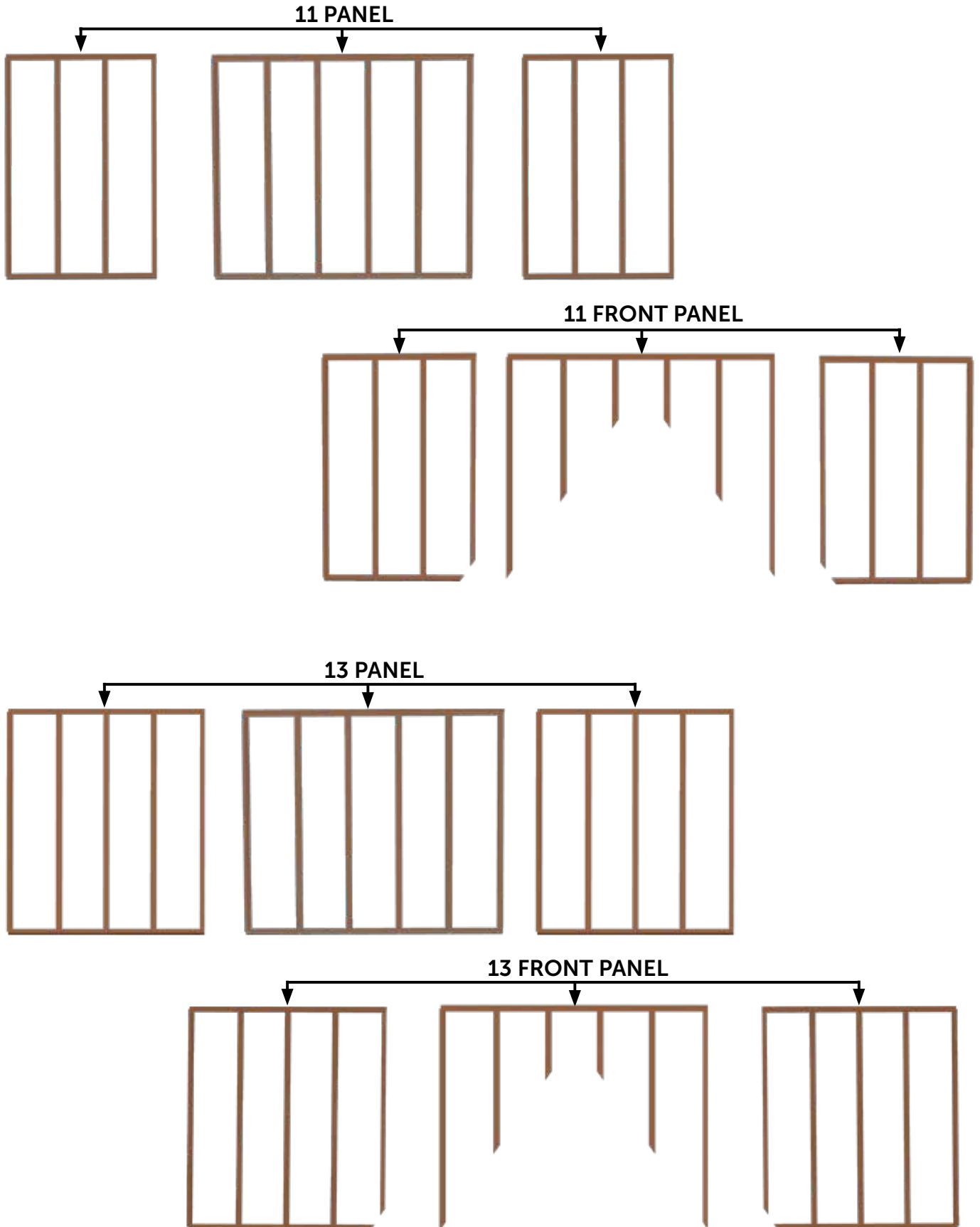

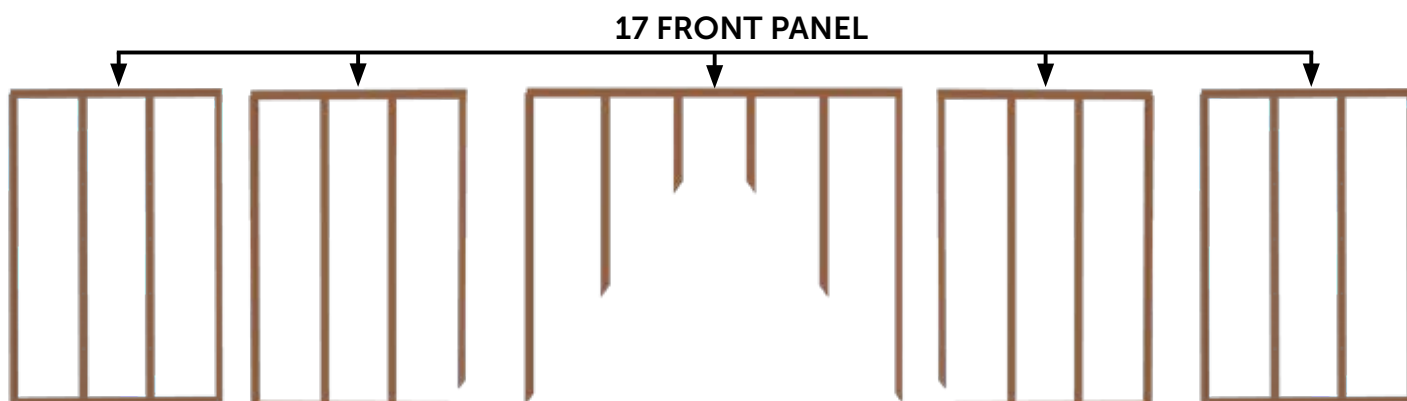
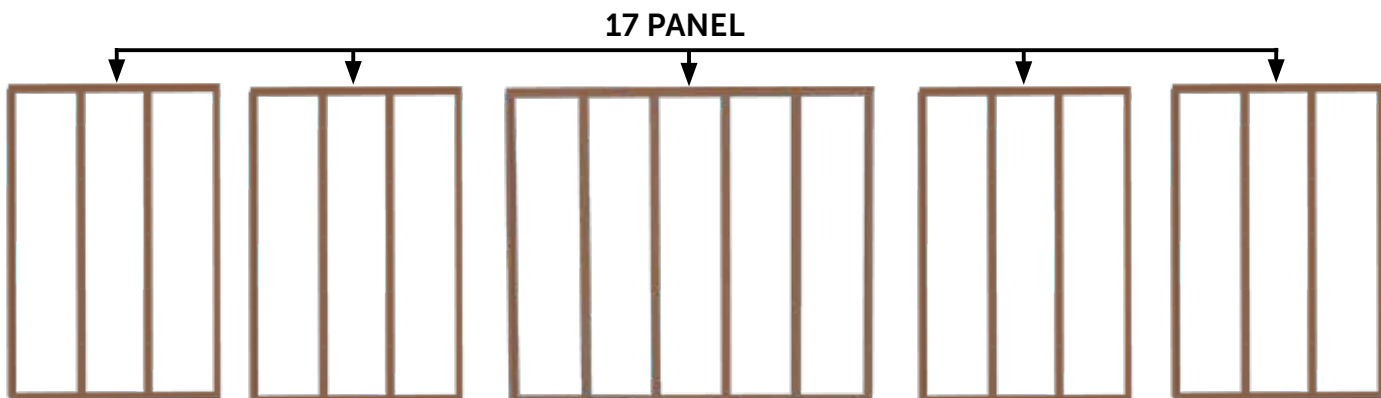
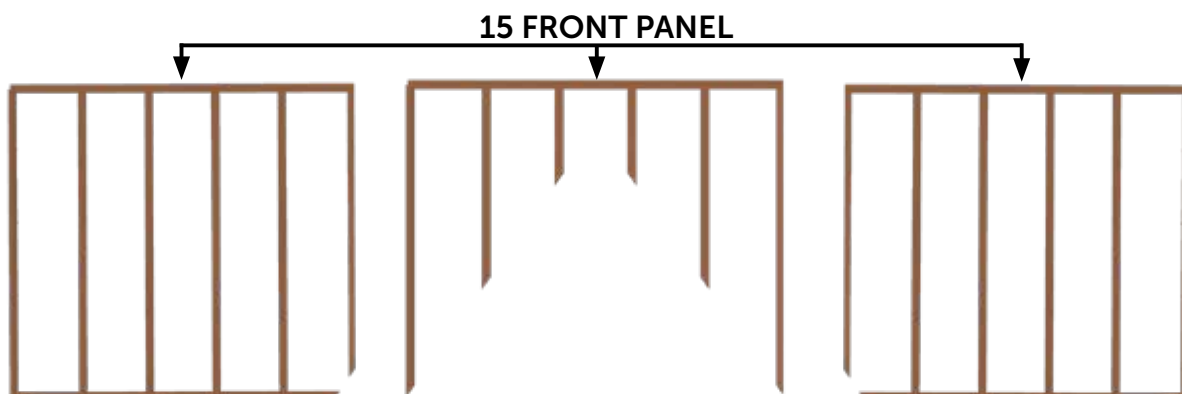
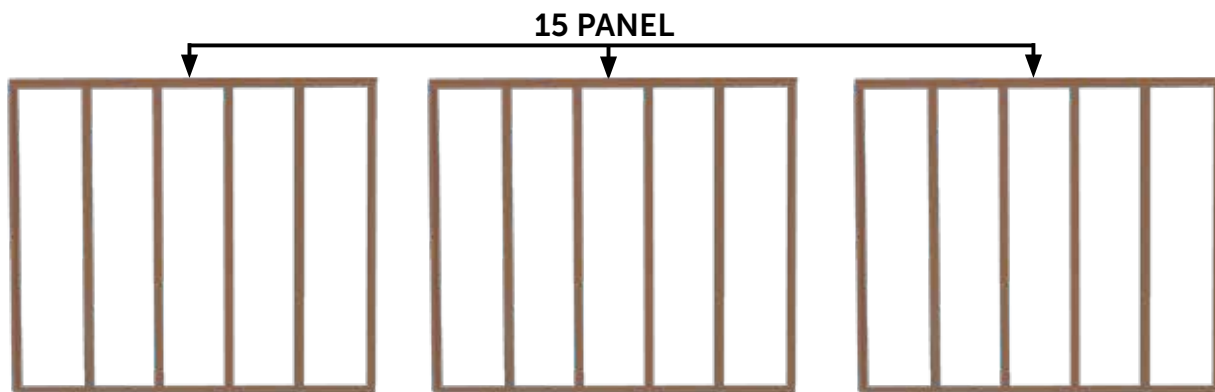

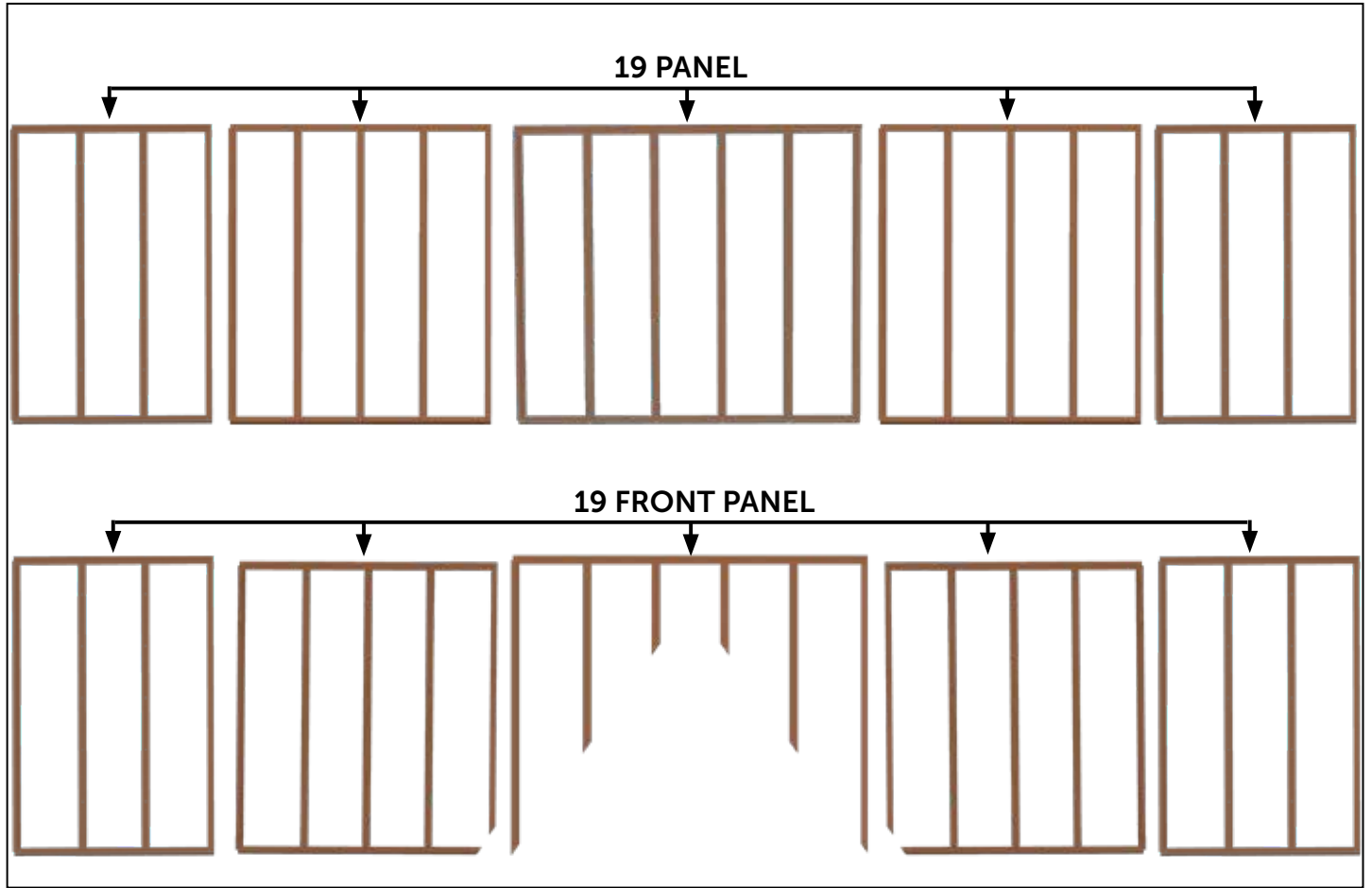

9.0

### RHS 'Grand' Portico

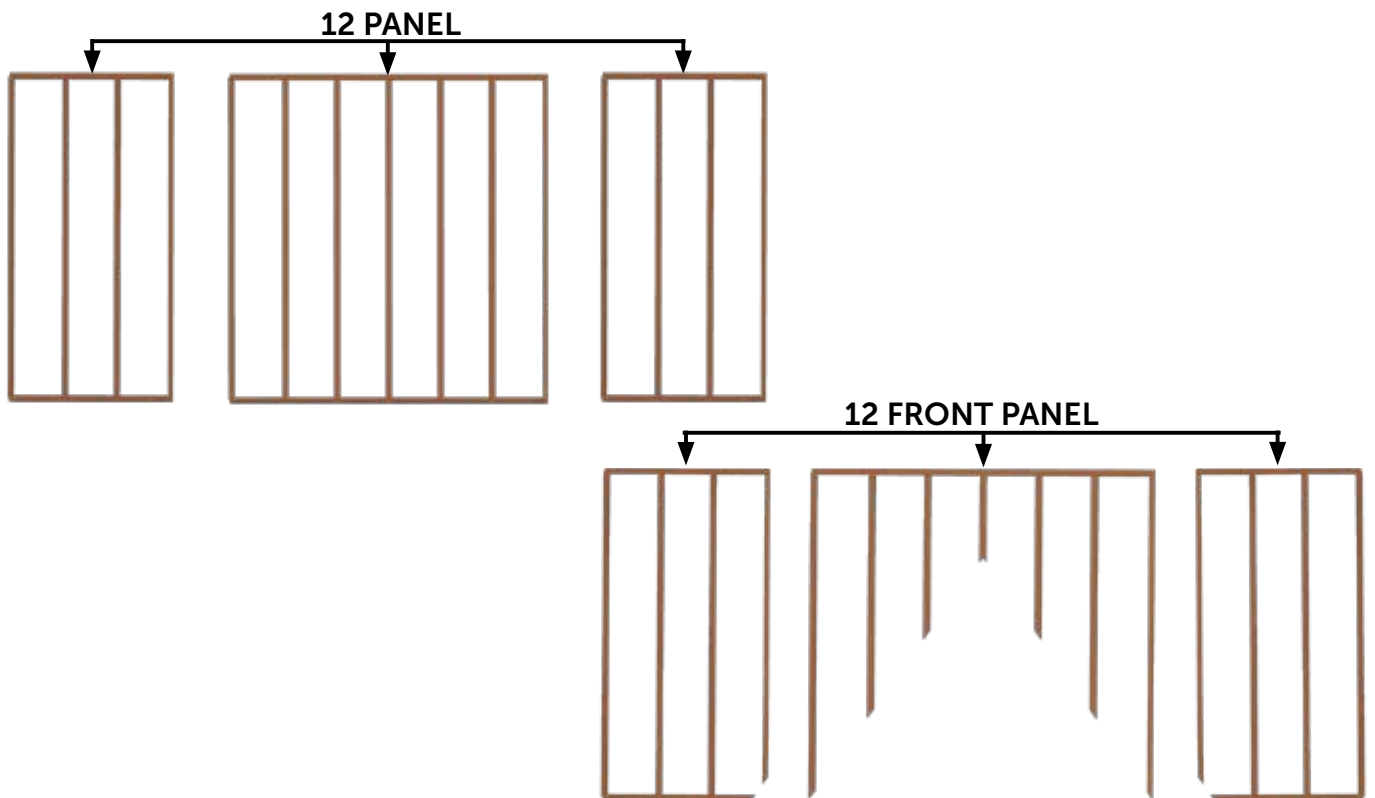

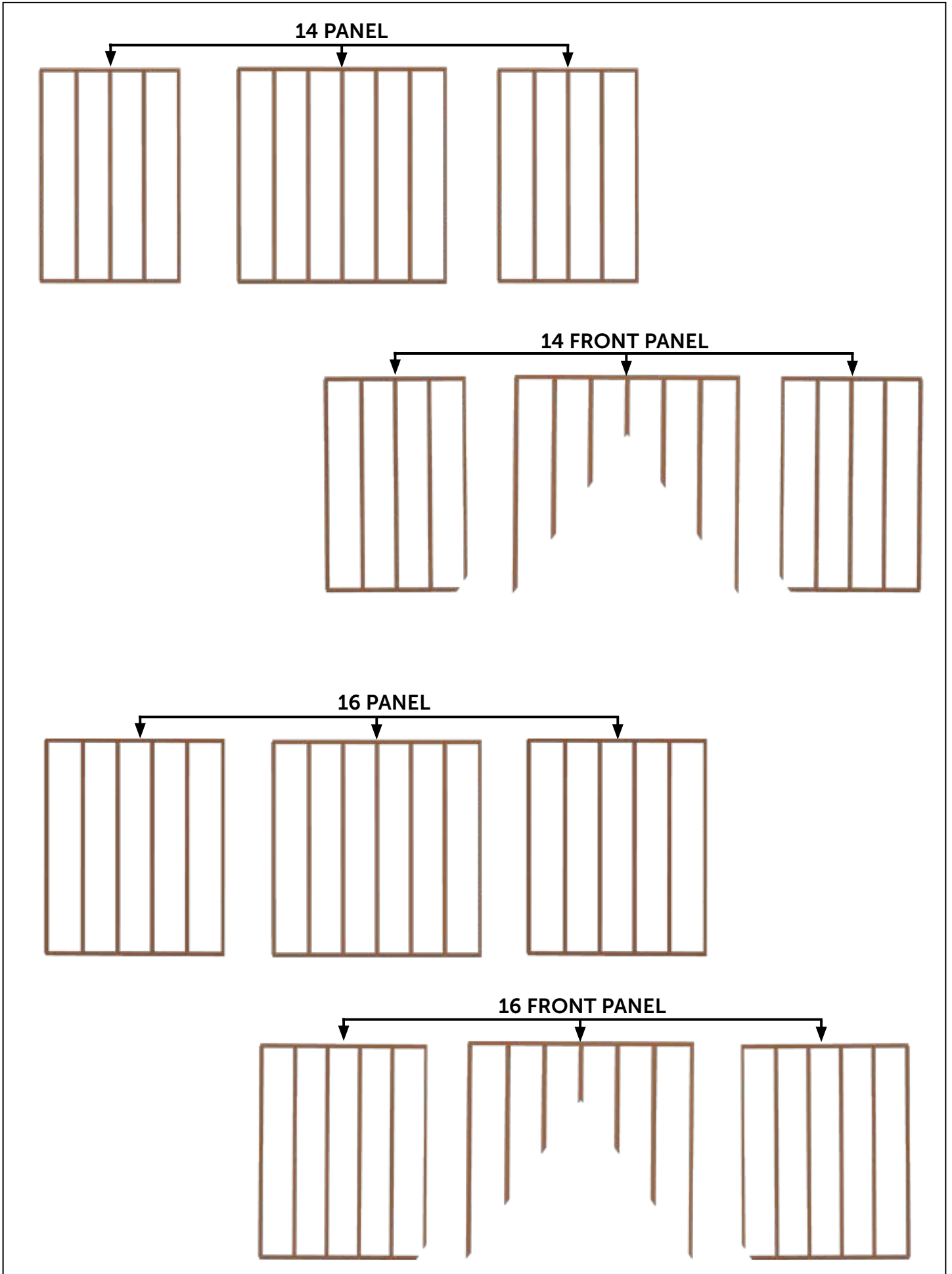

18 PANEL

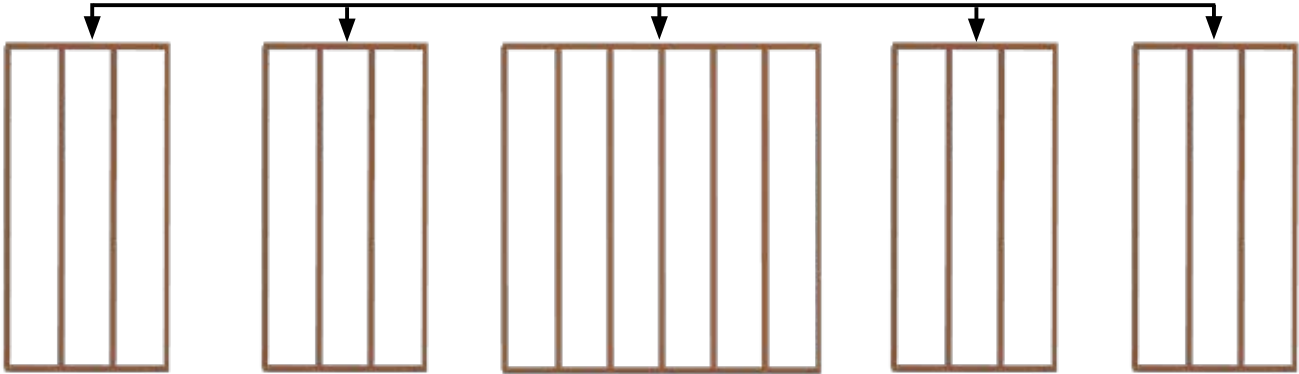

18 FRONT PANEL

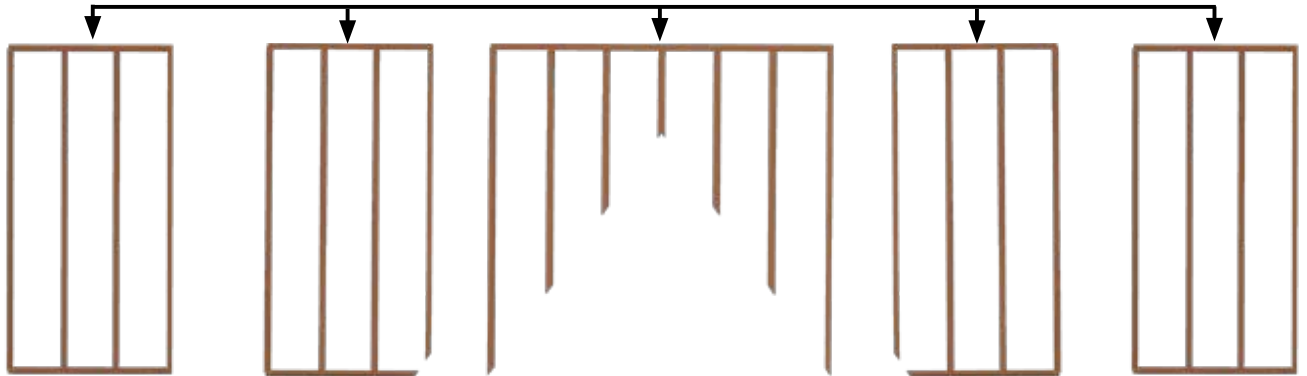

20 PANEL

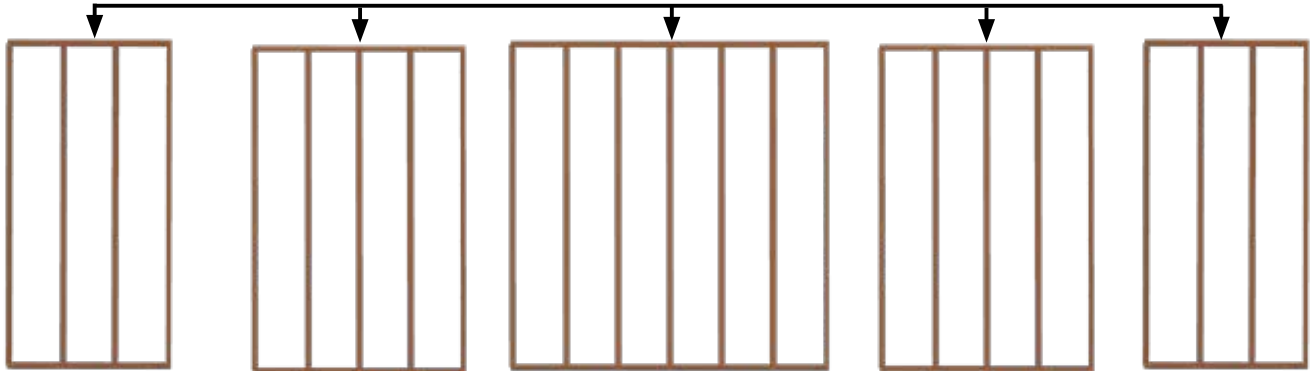

20 FRONT PANEL

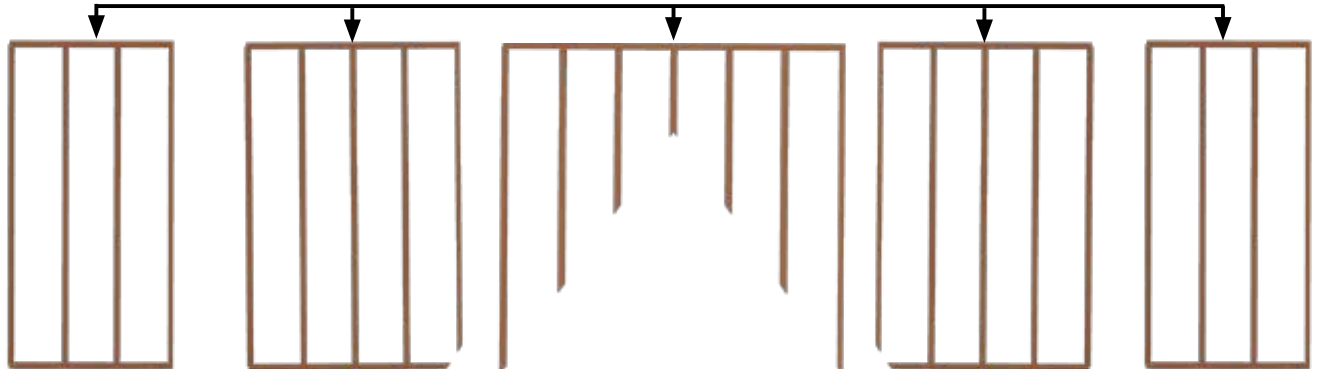

9.0

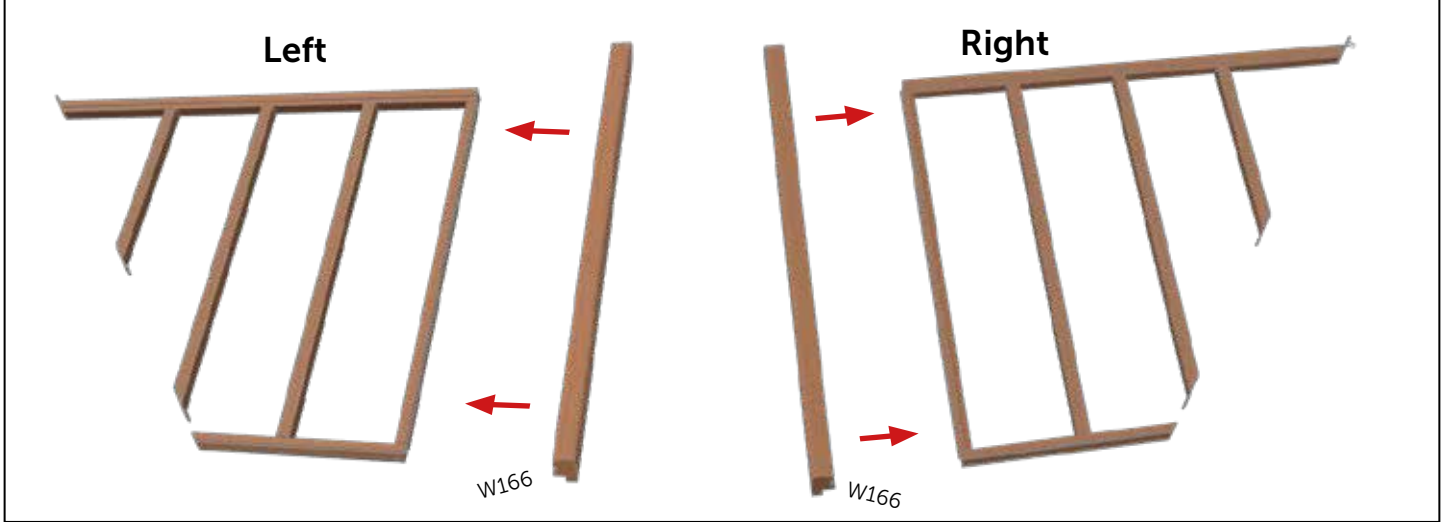

9.1

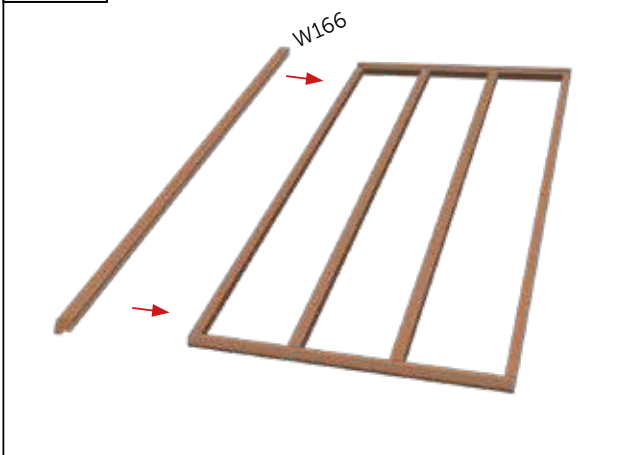

9.2

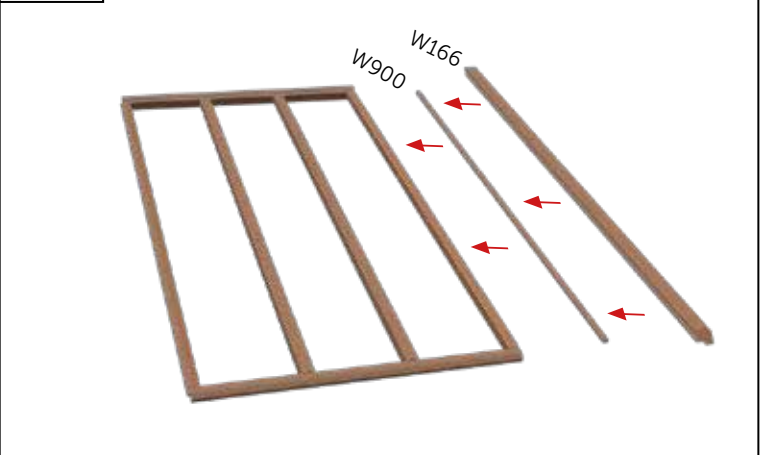

9.3

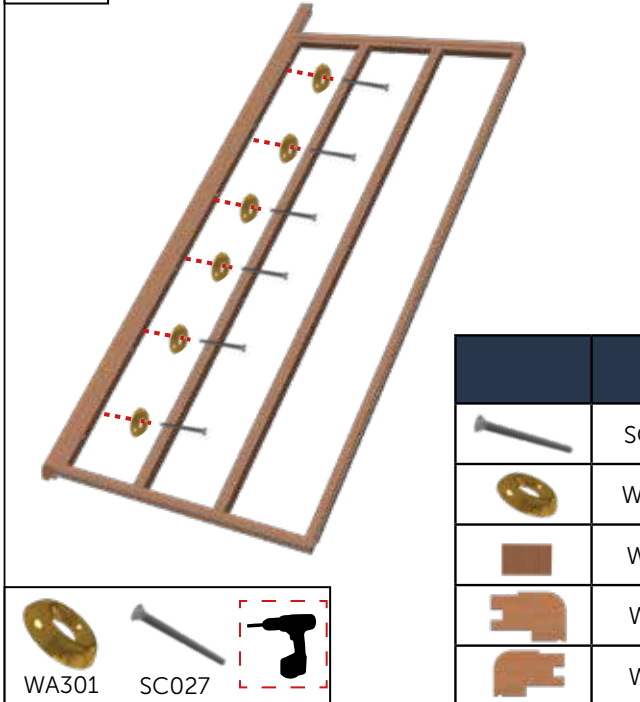

9.4

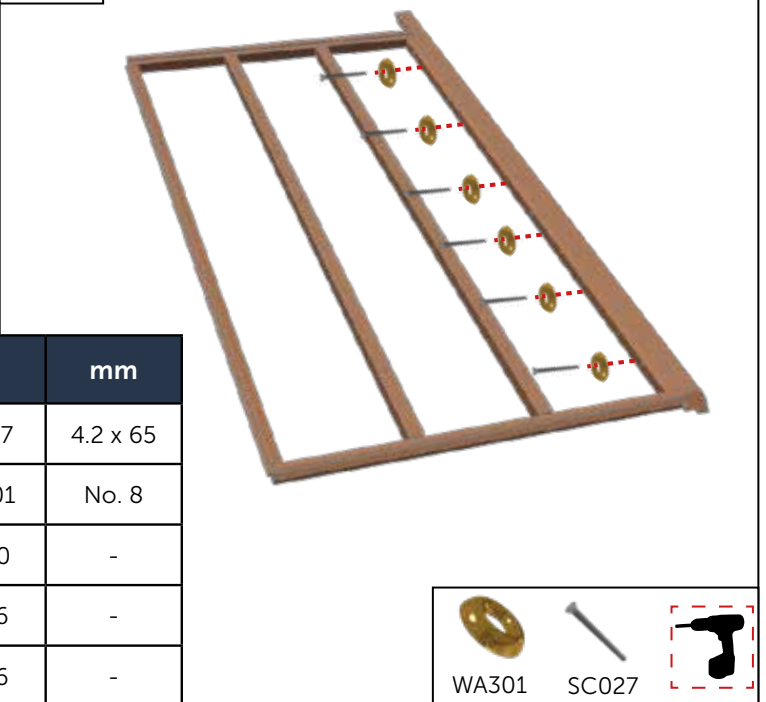

	#	mm
	SC027	4.2 x 65
	WA301	No. 8
	W900	-
	W166	-
	W166	-



10.0

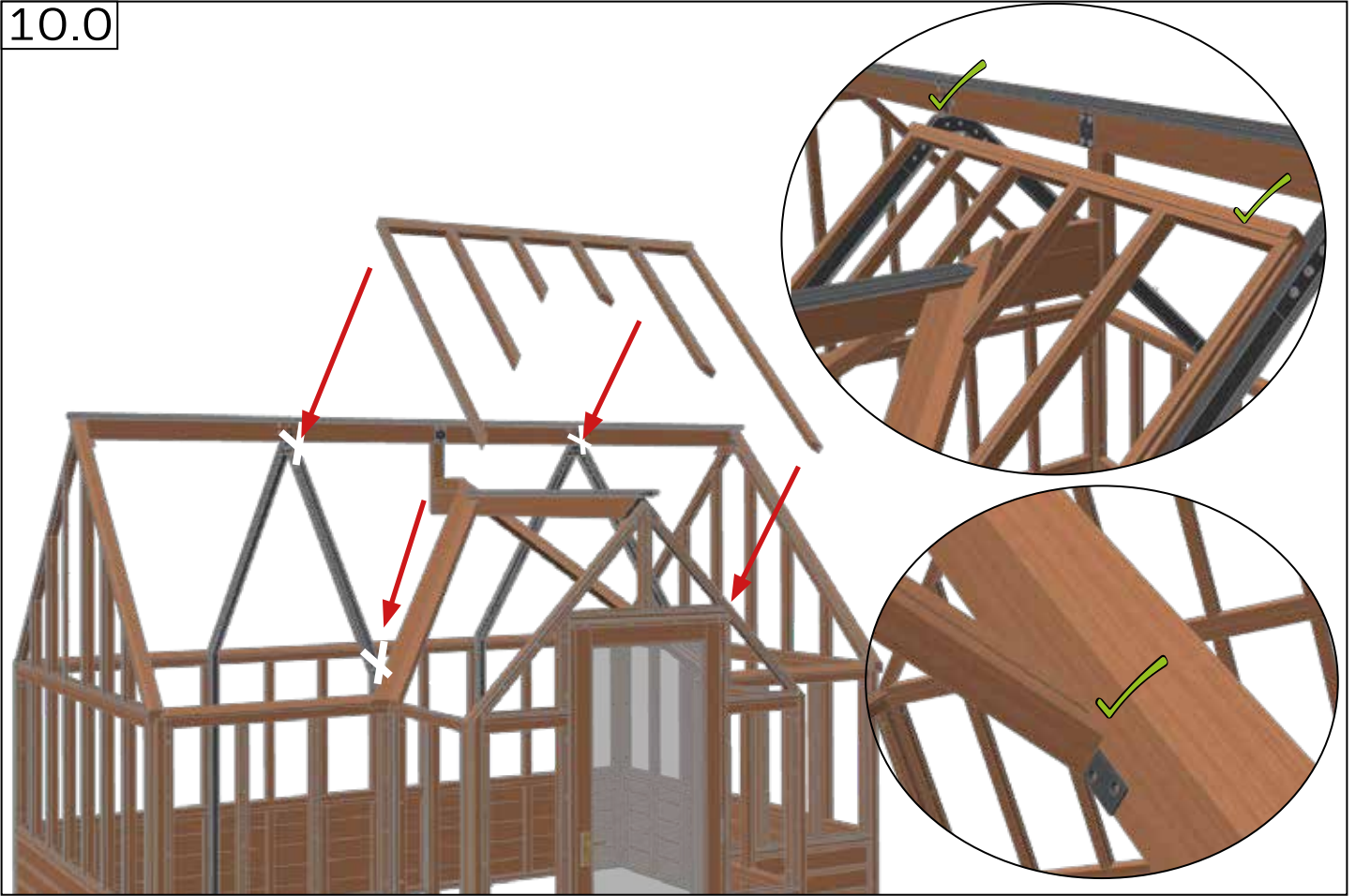

10.1

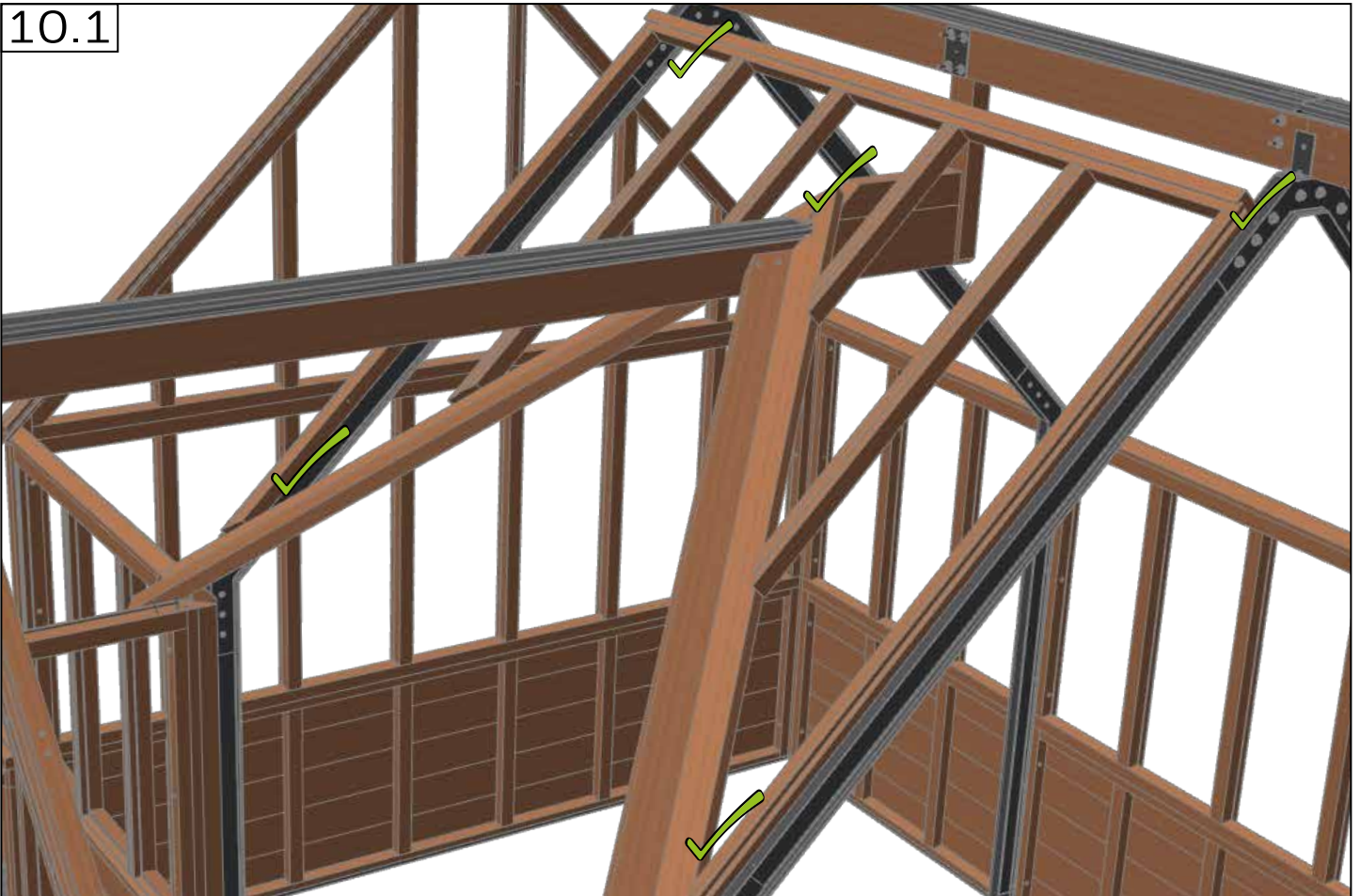



10.2

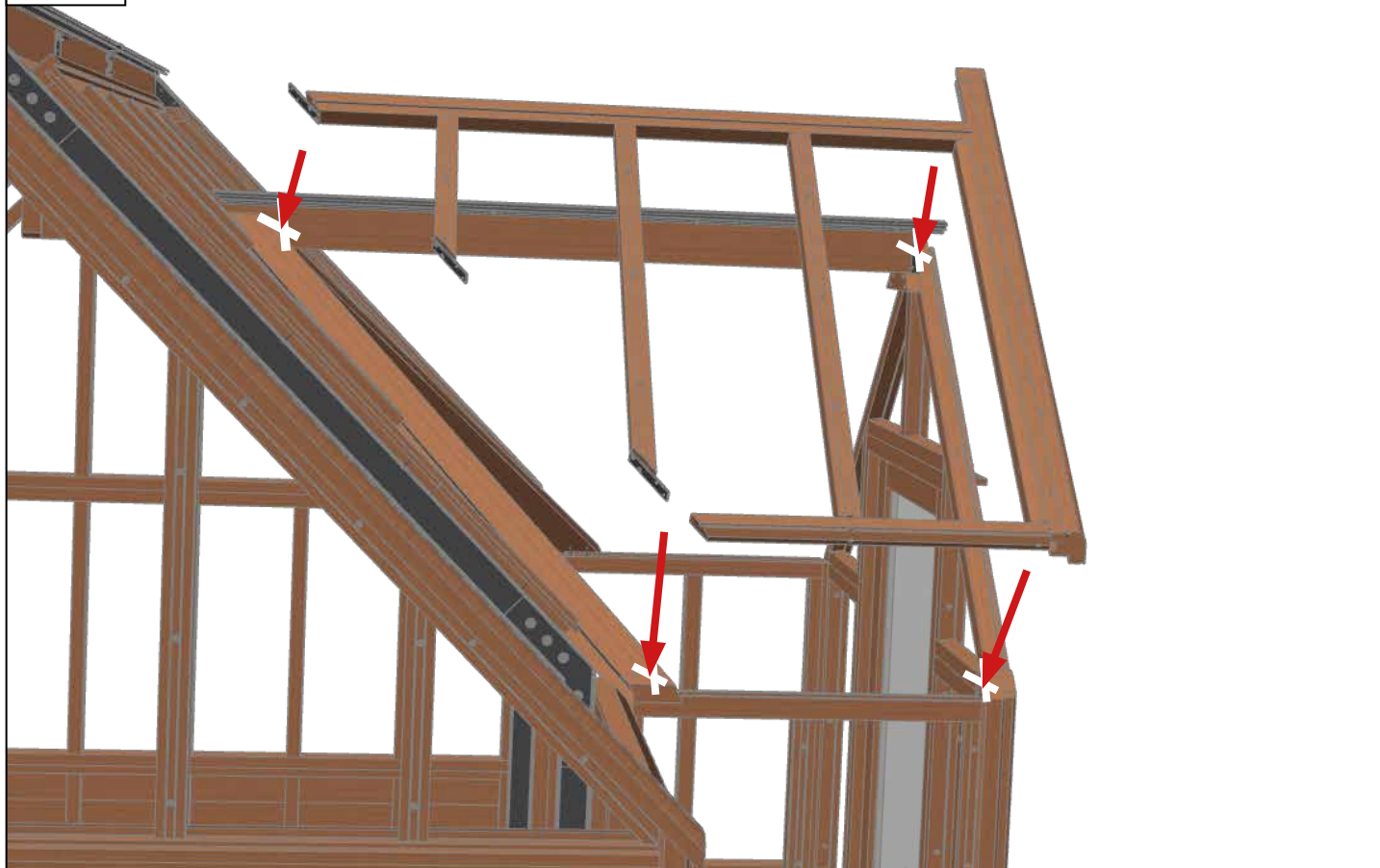

10.3



10.4



10.5

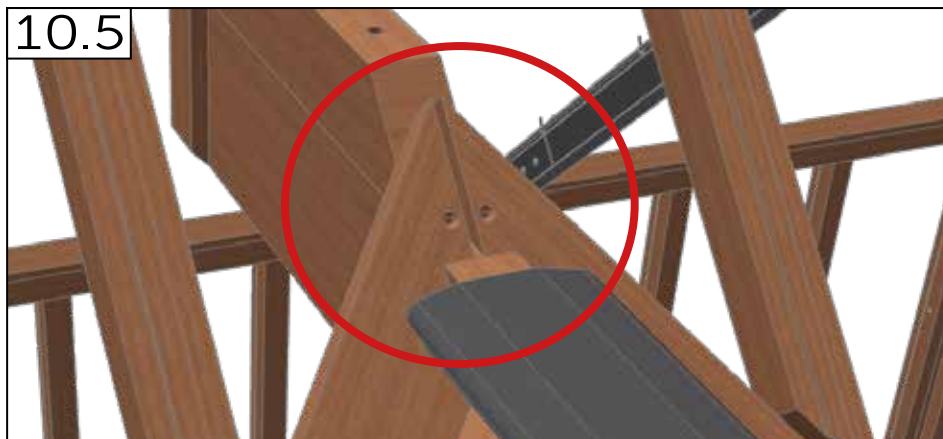

	#	mm
	SC024	4.2 x 38
	SC027	4.2 x 65

10.6

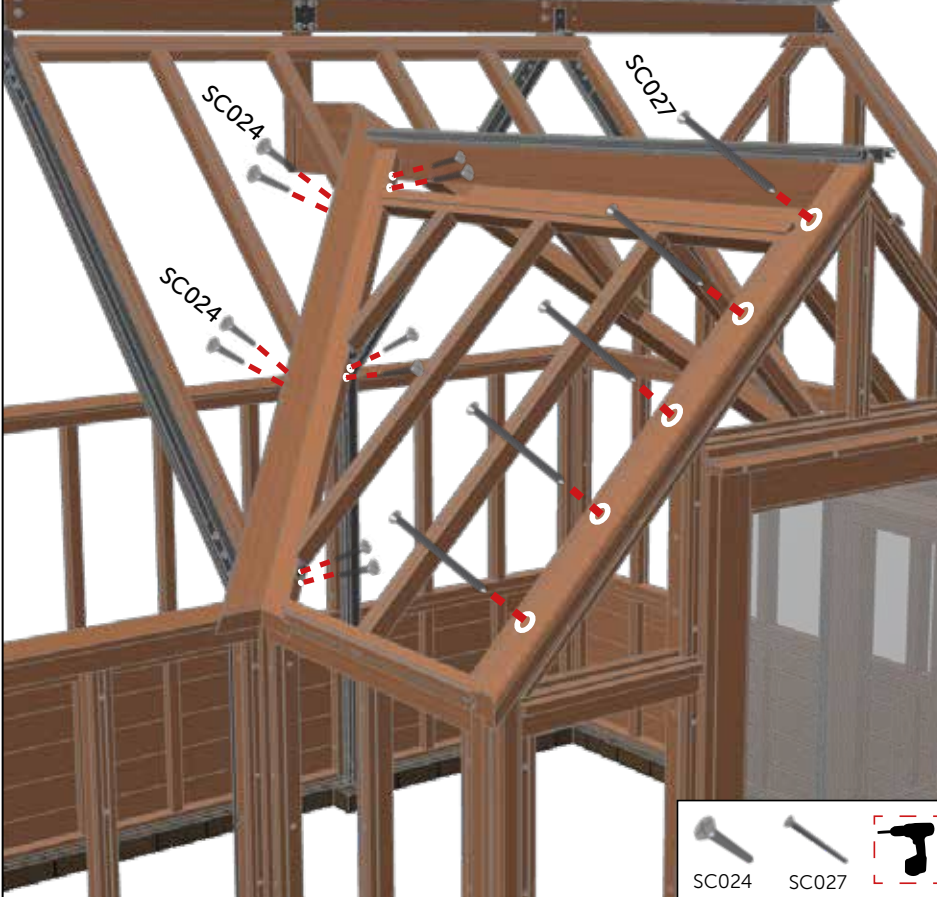

10.7



10.8

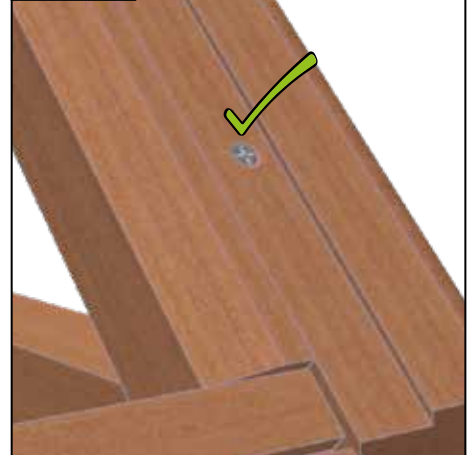

10.9

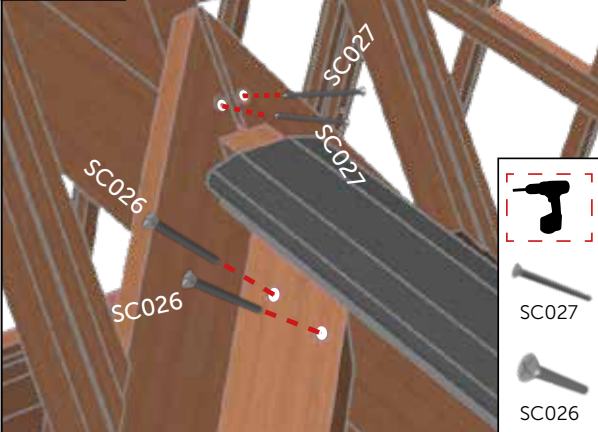

10.10

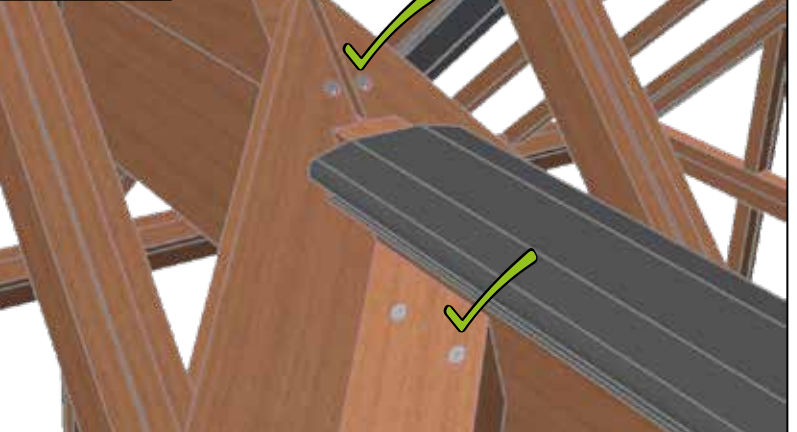

10.11

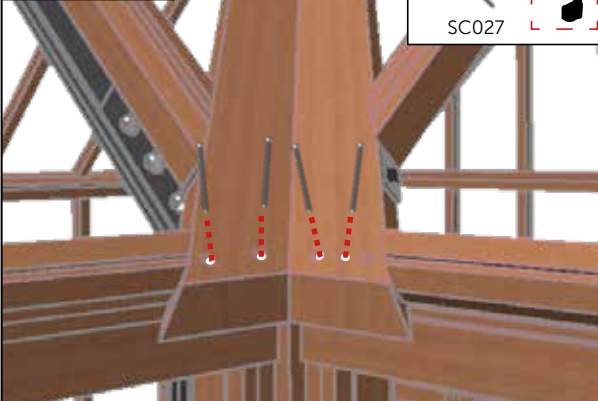

10.12

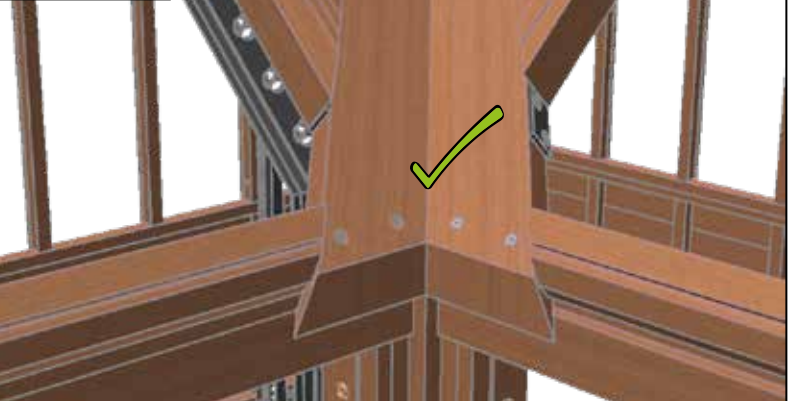

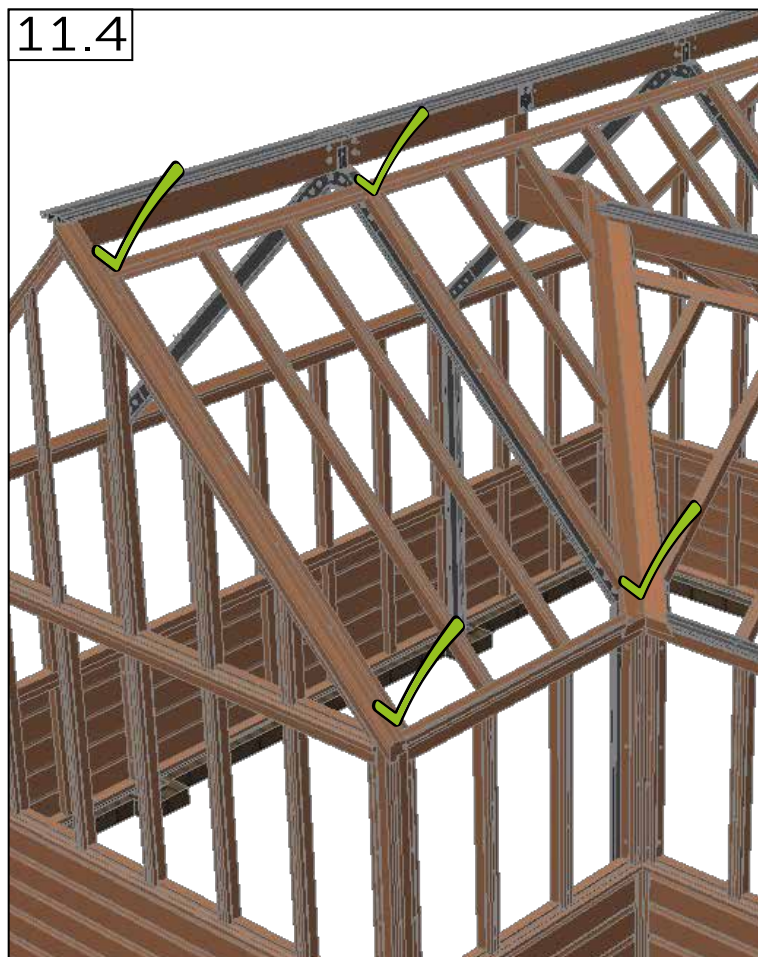
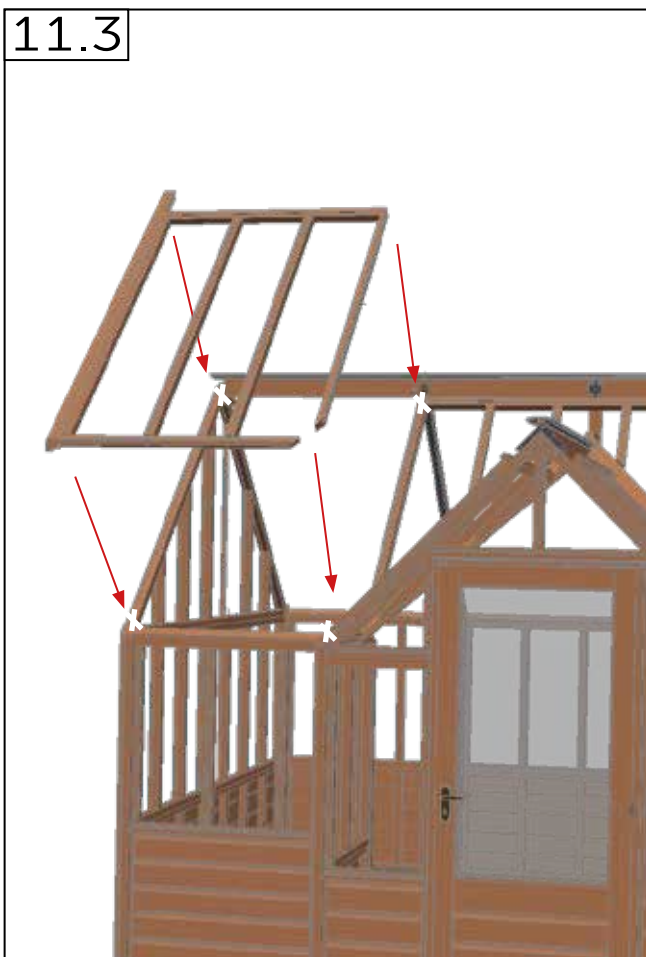
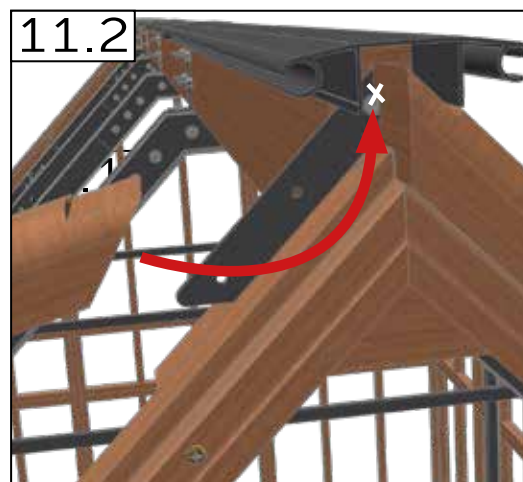
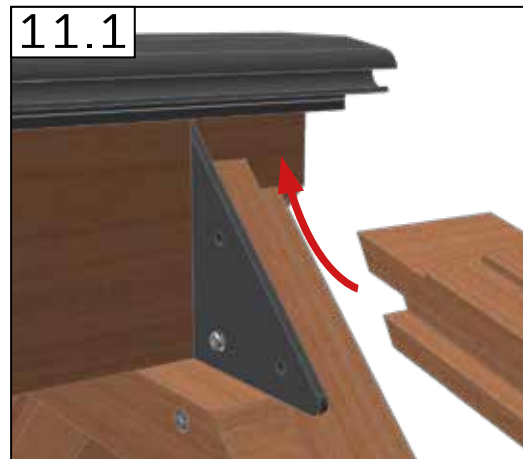
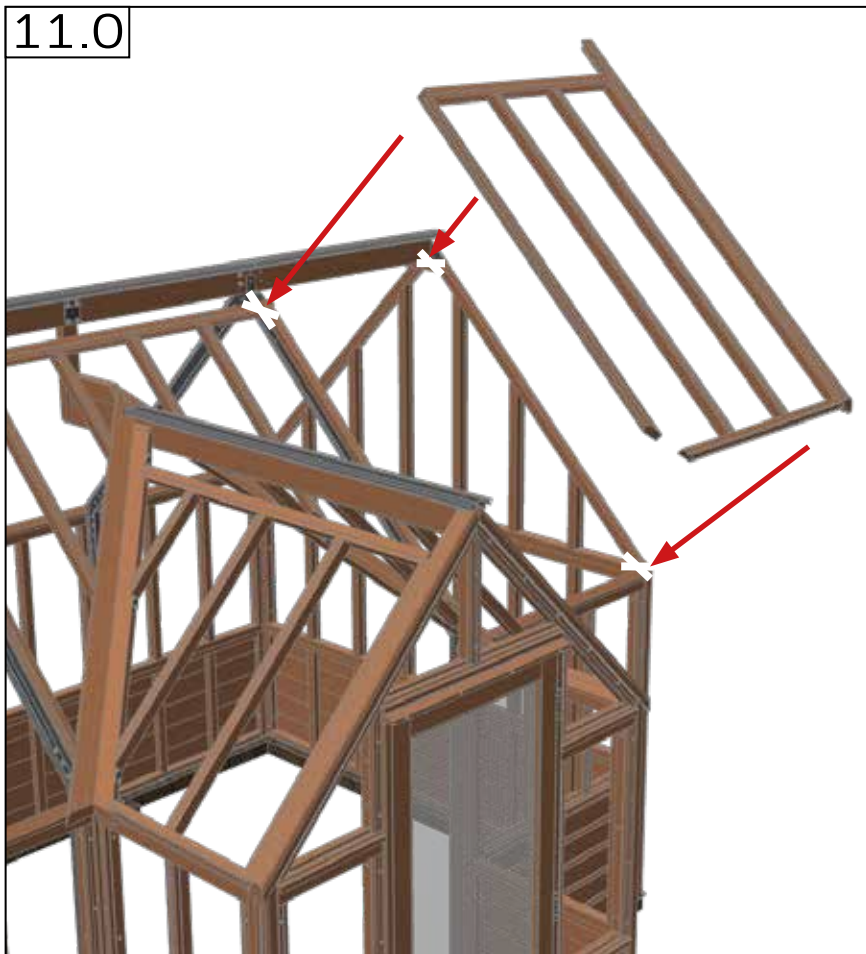

11.5

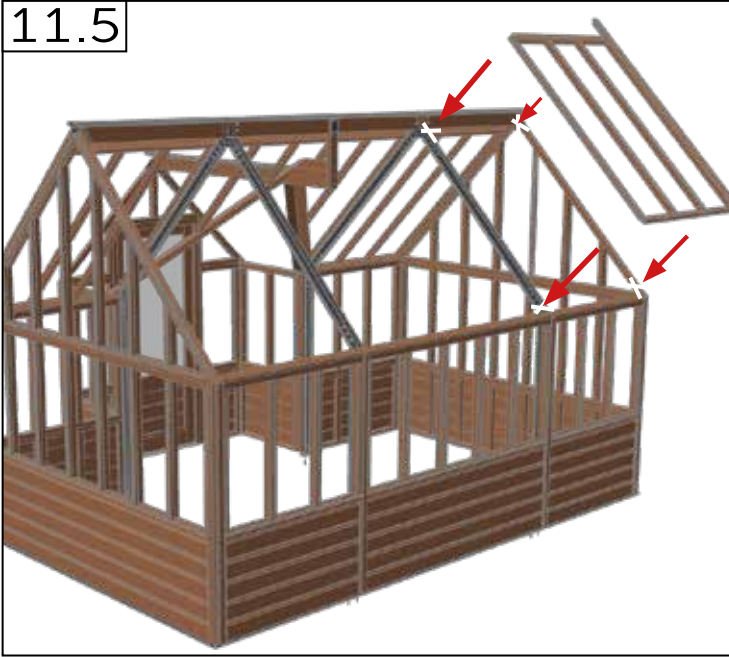

11.6



11.7

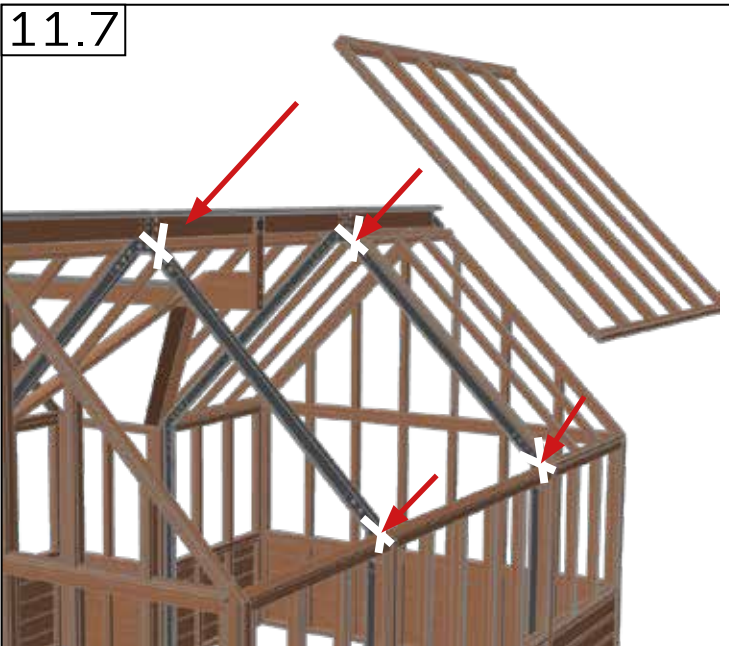

11.8

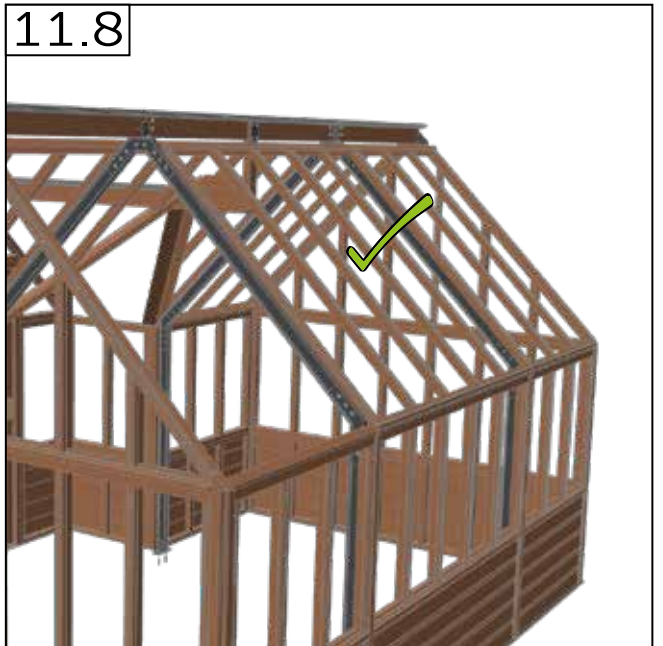

11.9

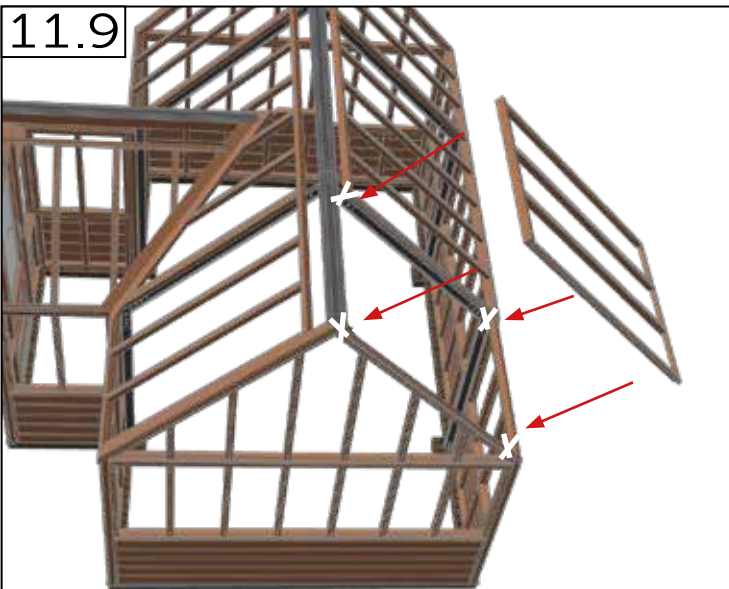

11.10

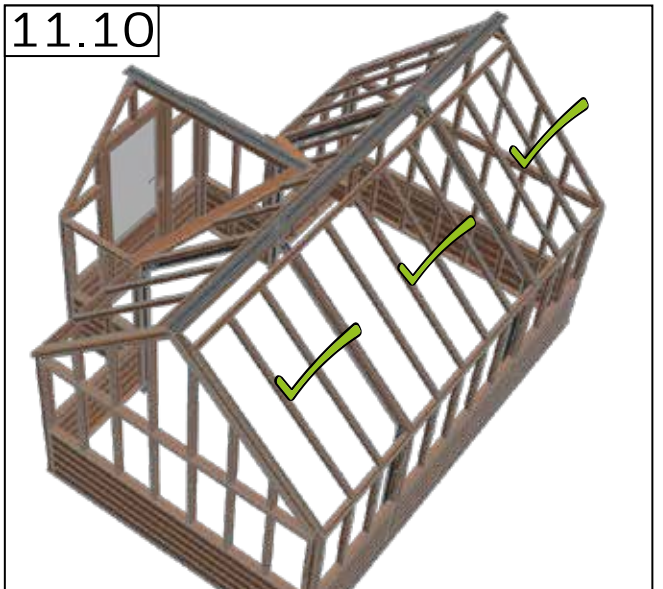

11.11



11.12



11.13

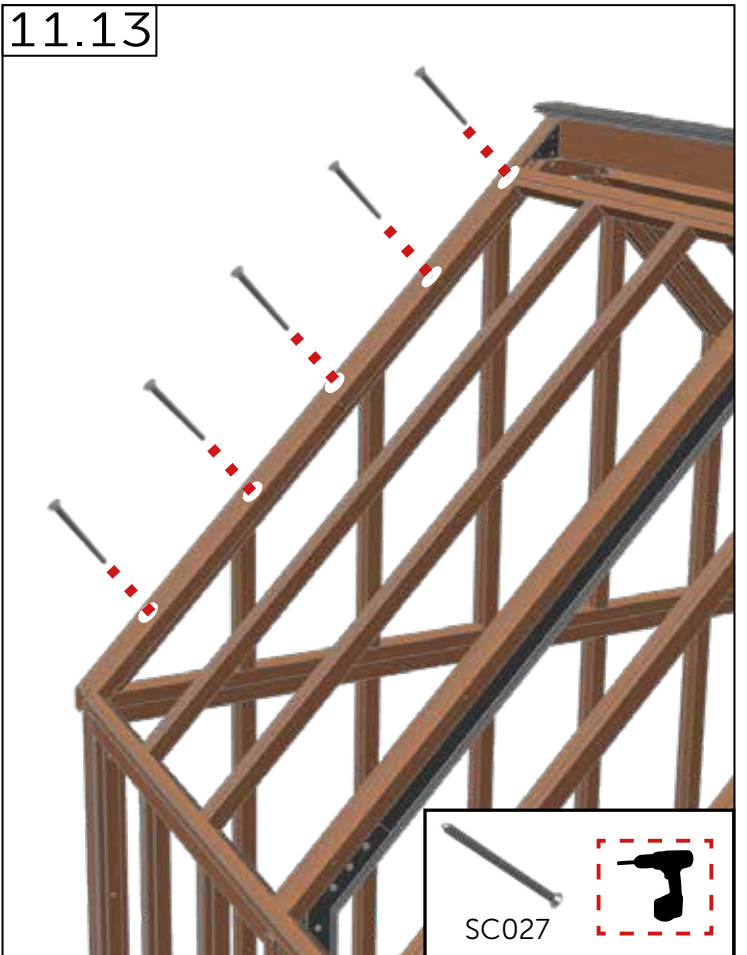

12.0

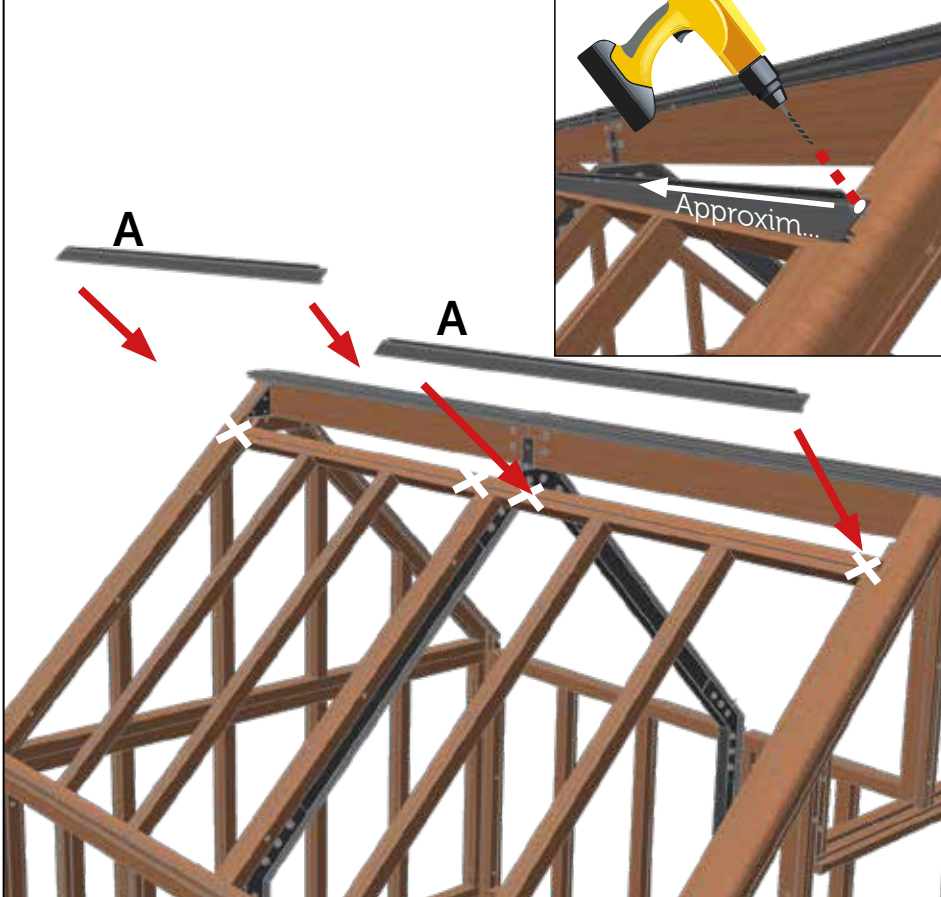

12.1



12.2

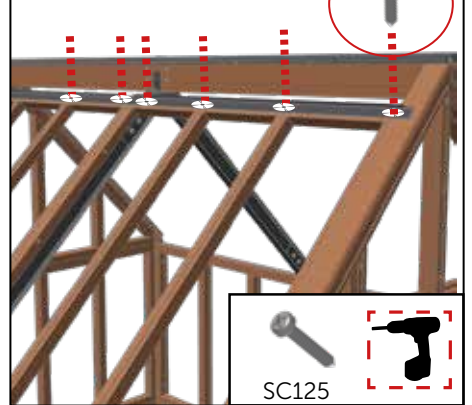

12.3

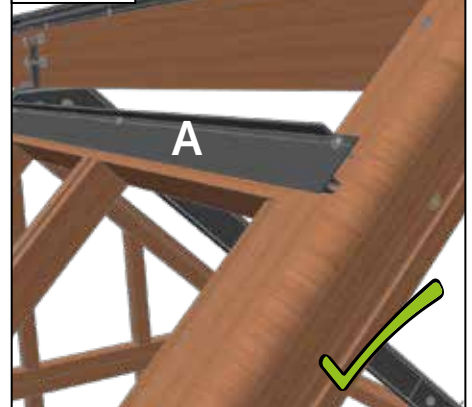

12.4

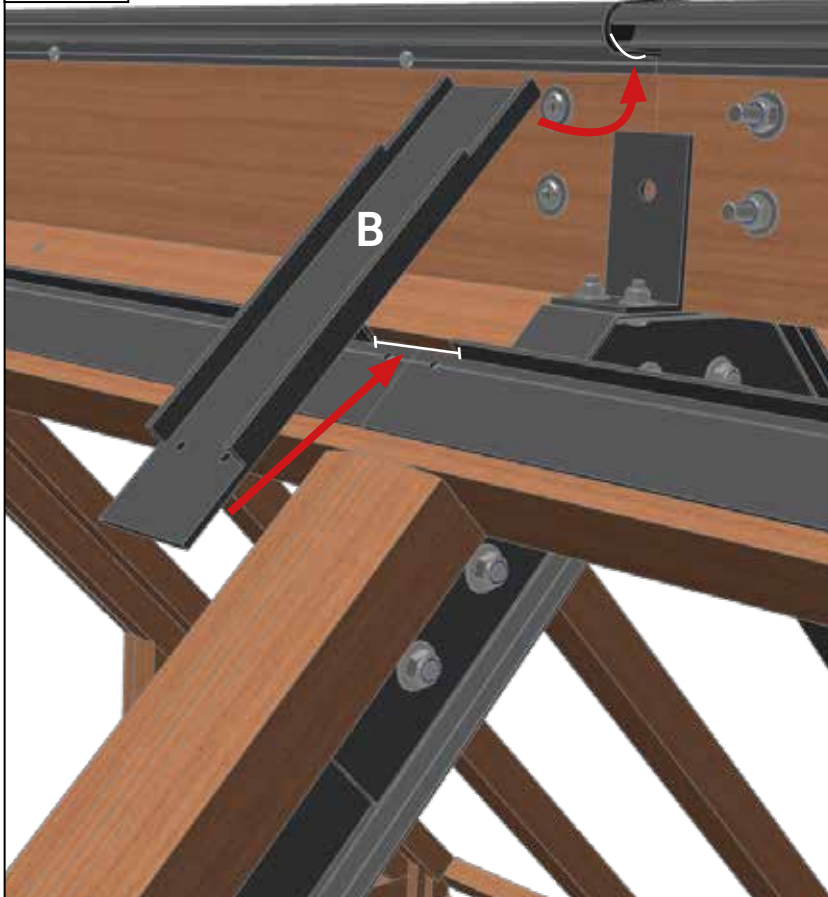

12.5

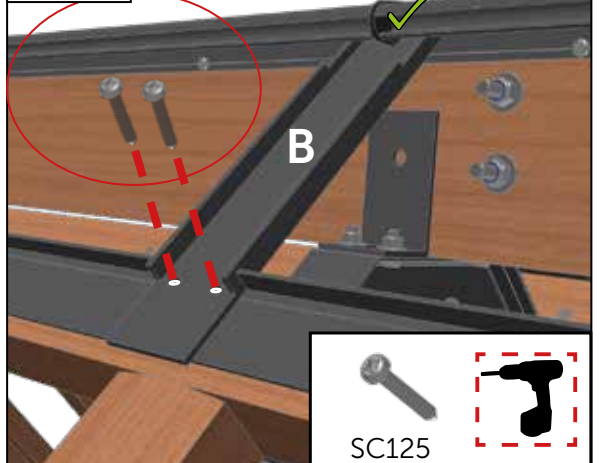

12.6

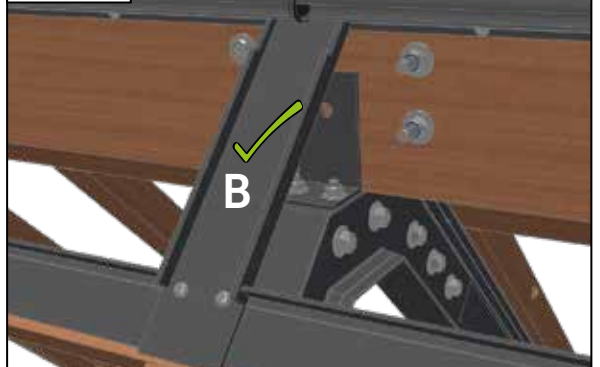

Trims - Trimmer - Trimmen - Garnitures - Versierungen - Trimmit  
 - Wykończenia - dornos

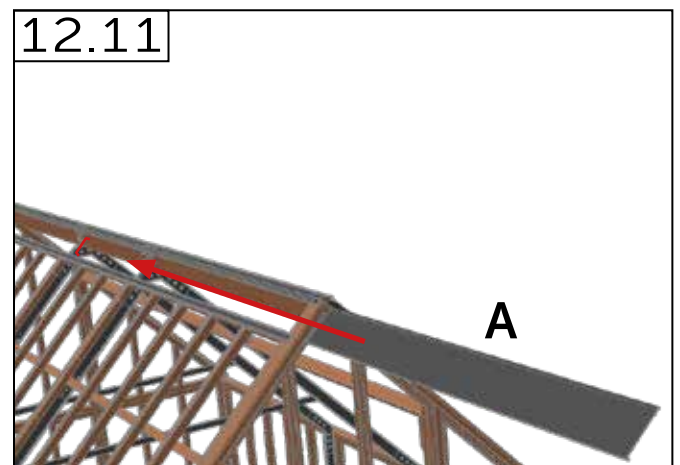
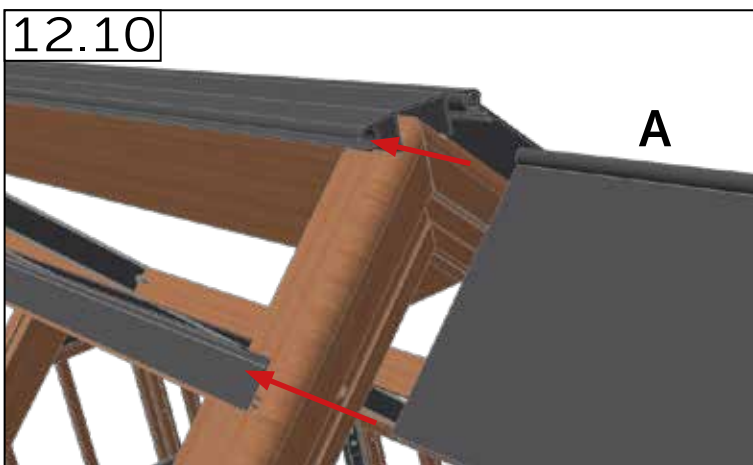
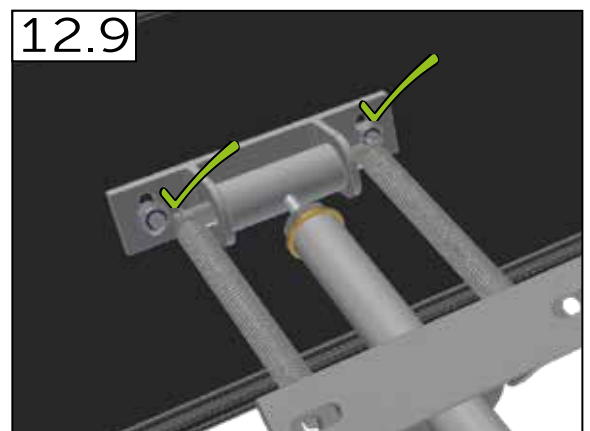
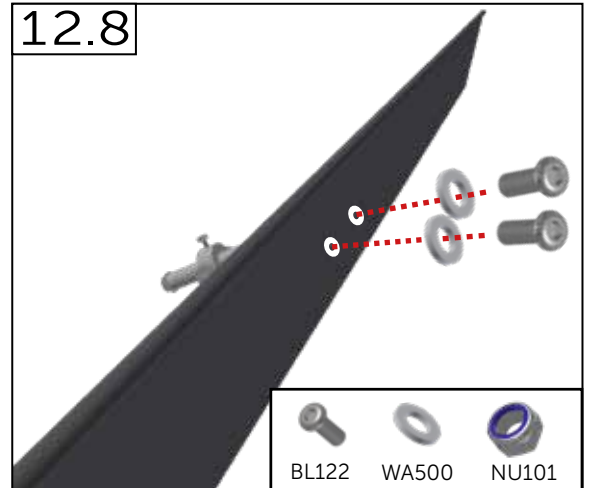
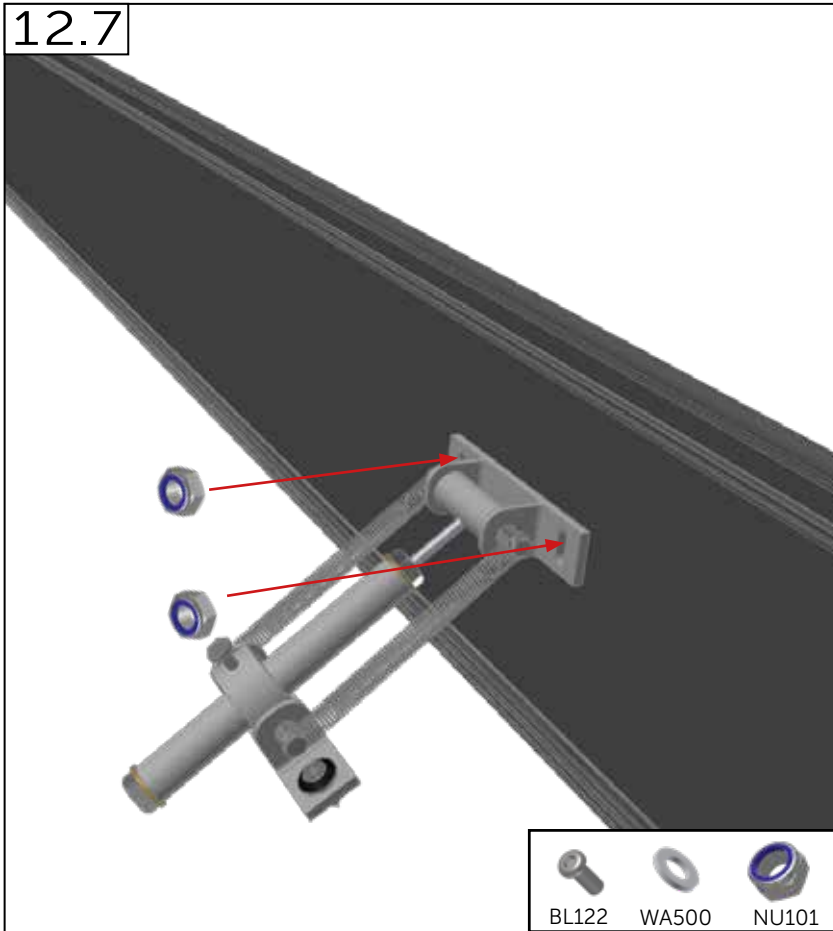

	#	mm
	A,B AL2000	-
	AV001	-
	WA500	M6 x 16
	NU101	M6
	BL122	M6 x 16

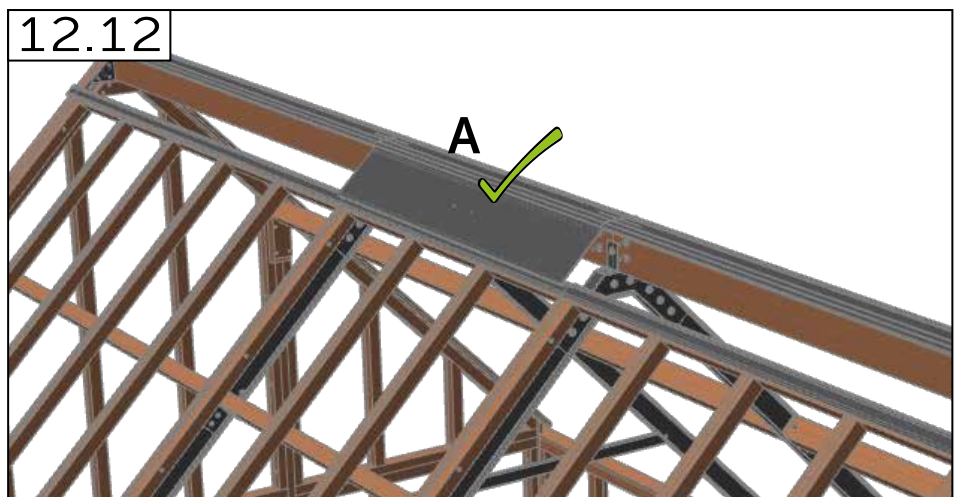

12.13

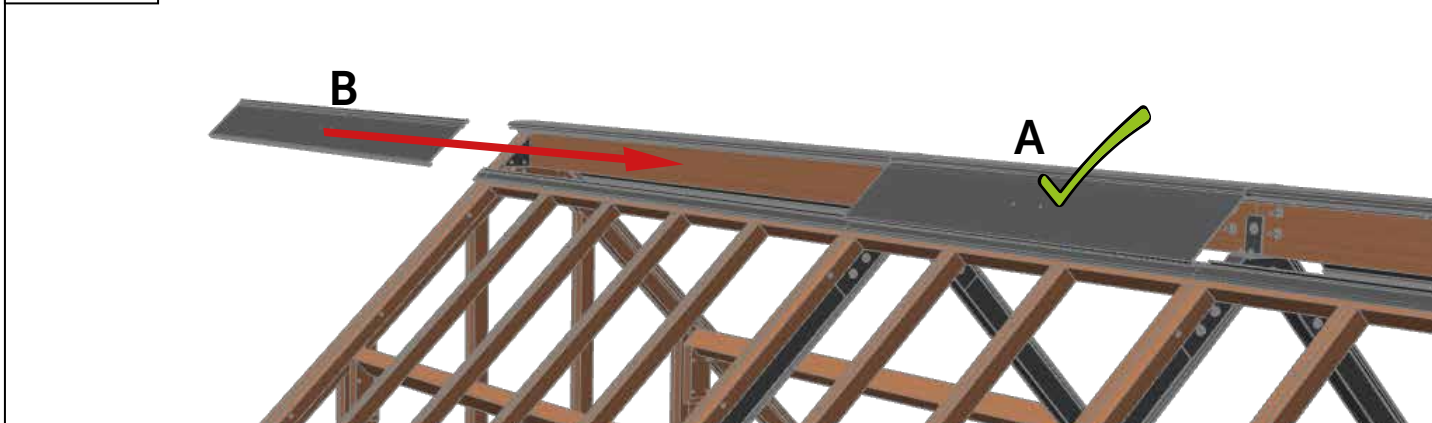

12.14

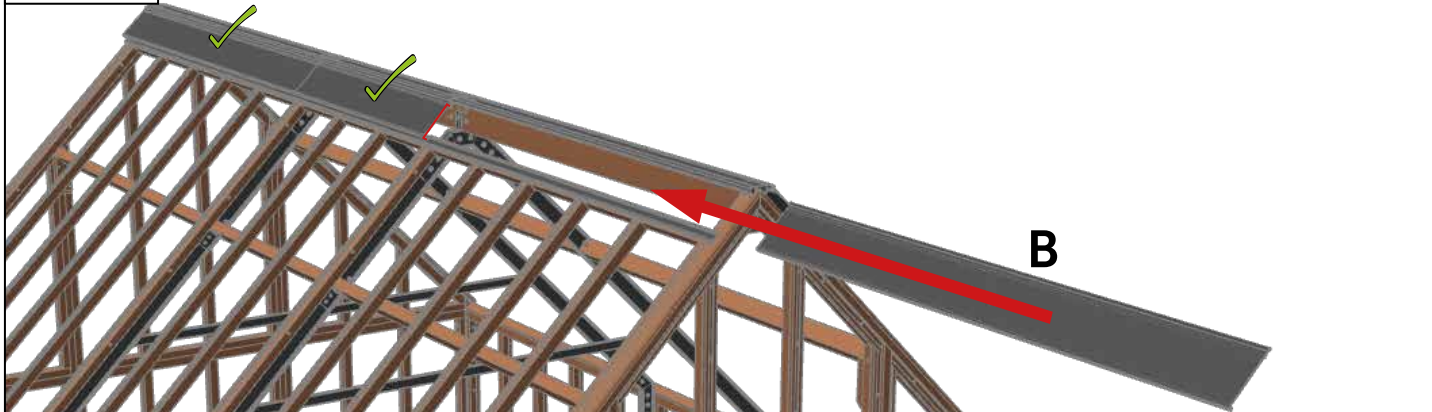

12.15

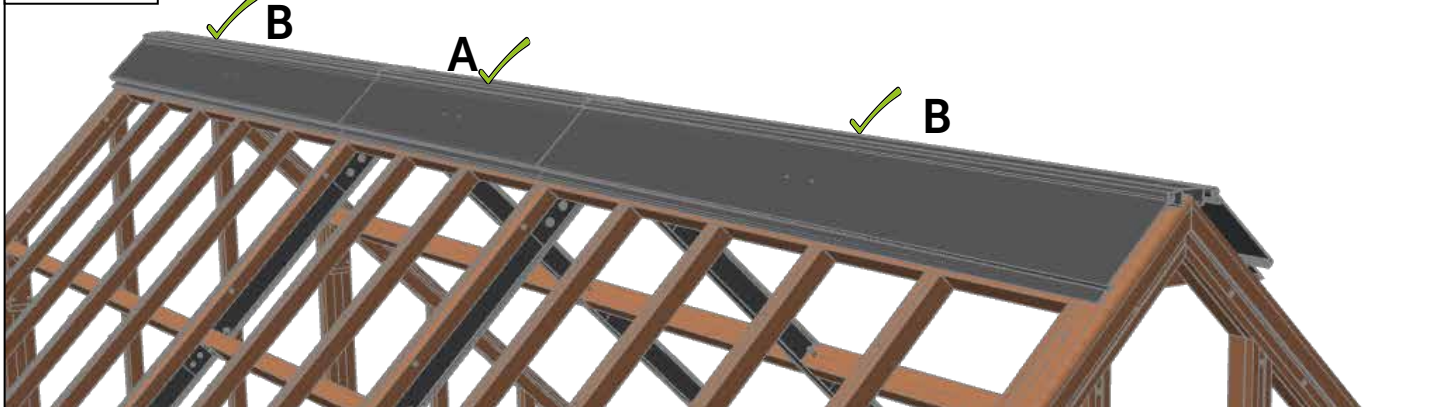

12.16

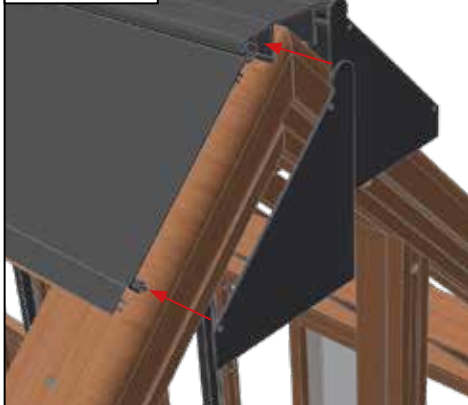

12.17

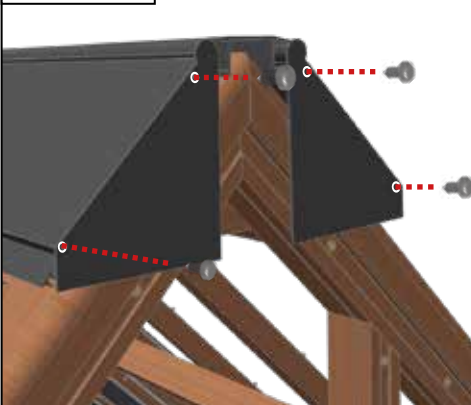

12.18

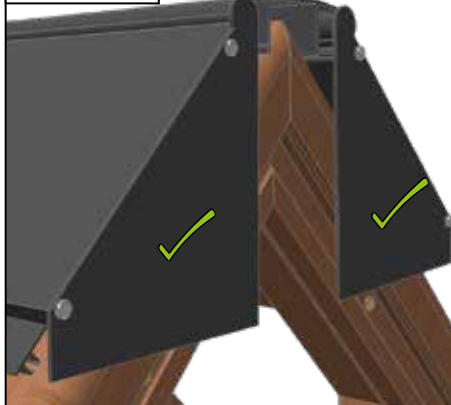



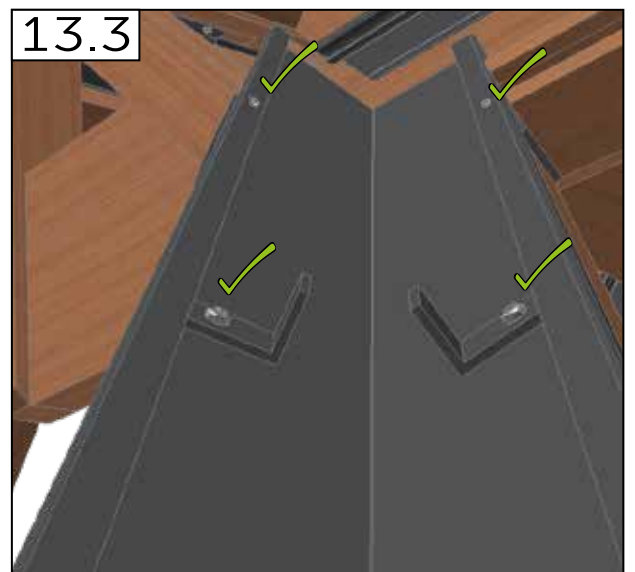
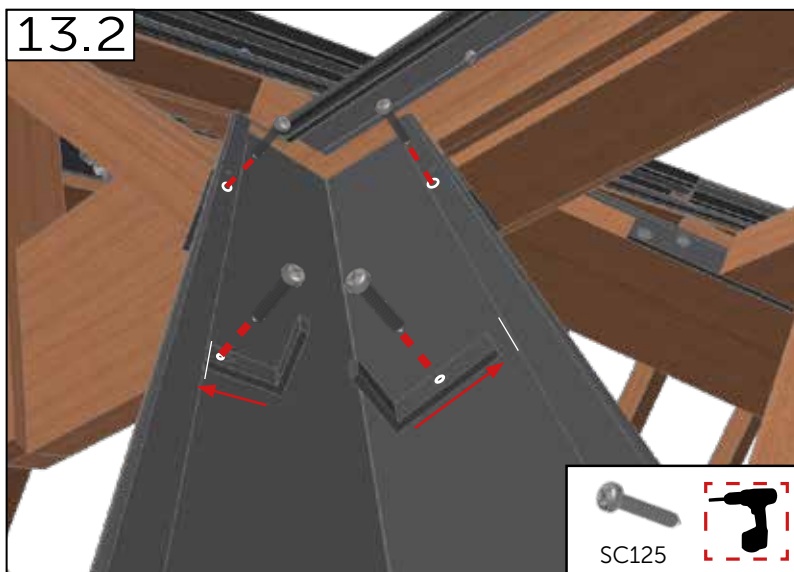
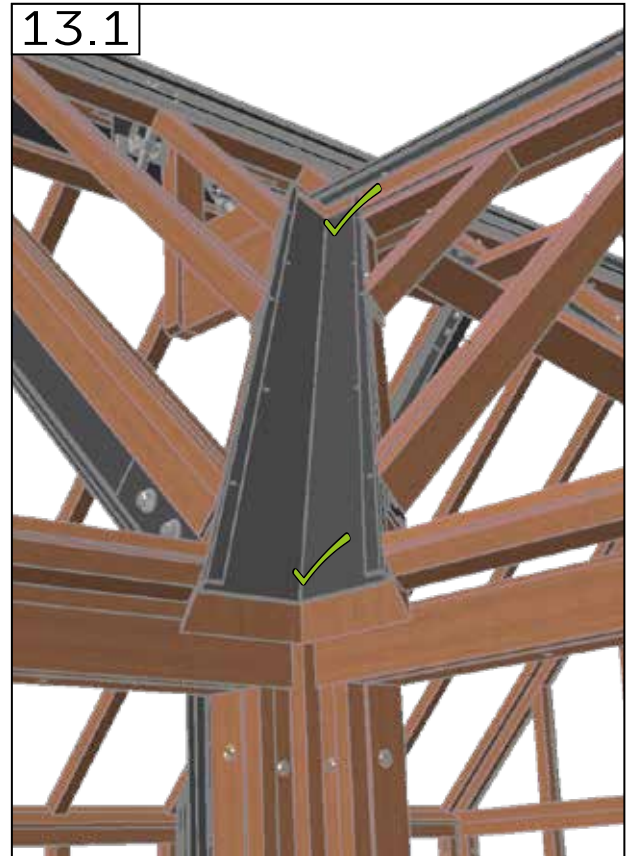

	#	mm
	AL3412	-
	AL3046	-
	SC125	4.2 x 25

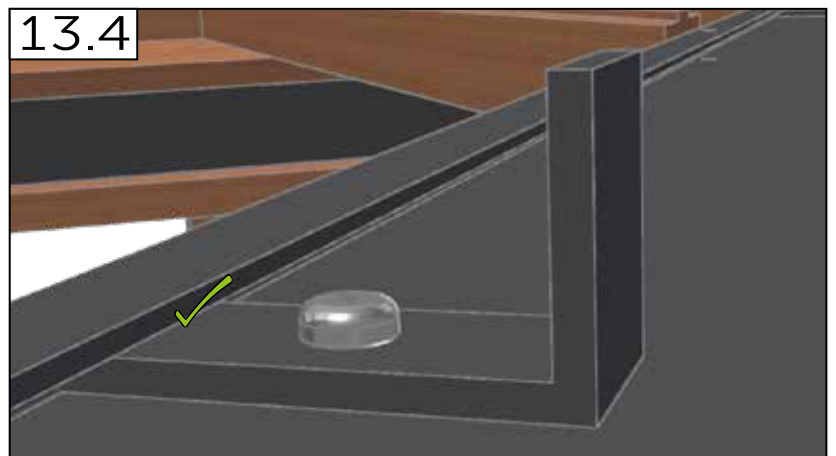

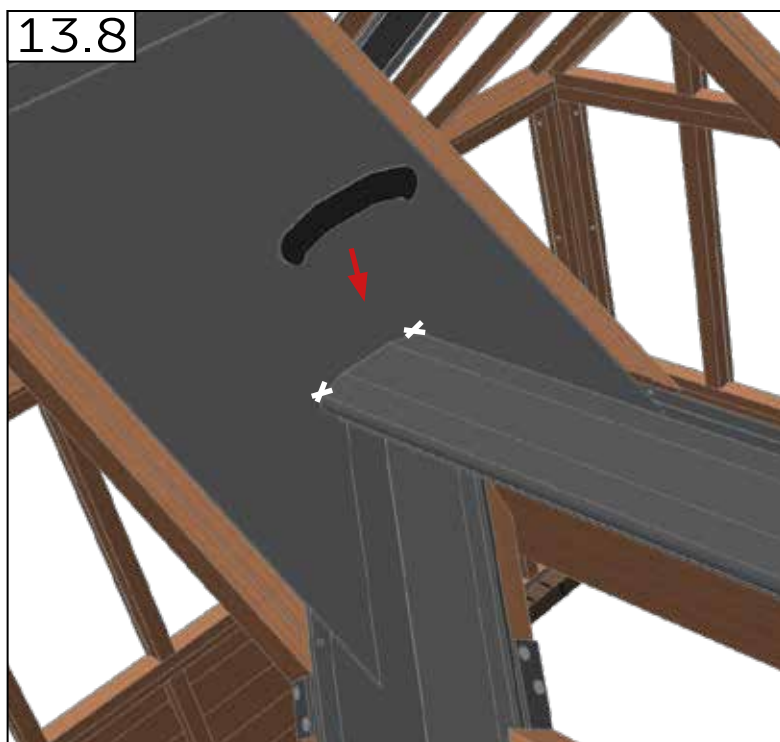
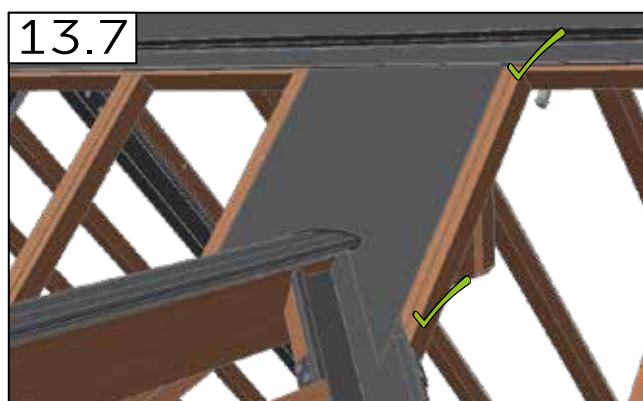
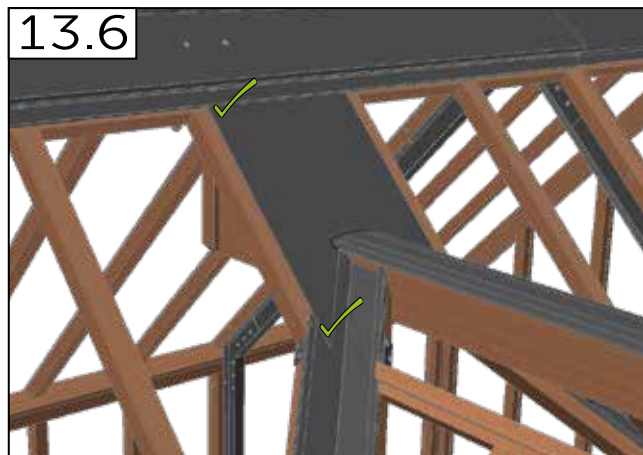
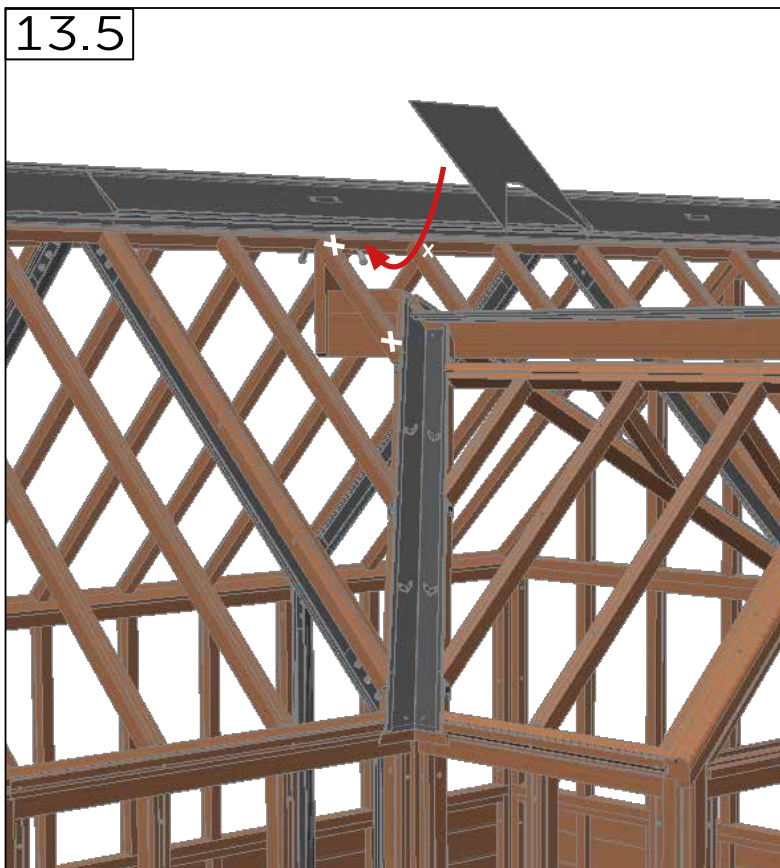

	#	mm
	AL3090	-
	AD001	-

14.0

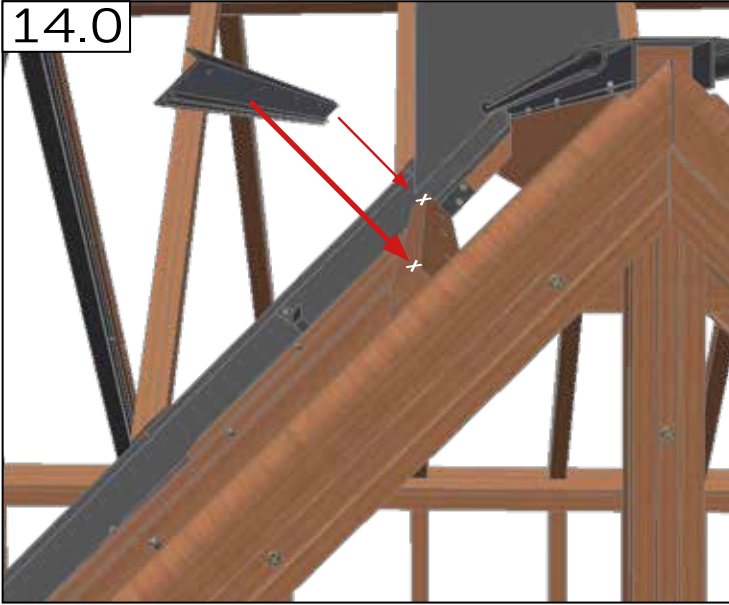

14.1

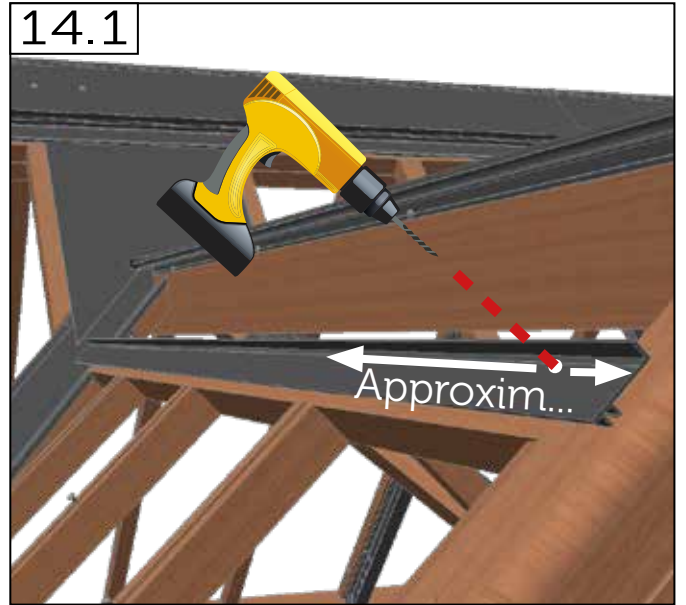

14.2

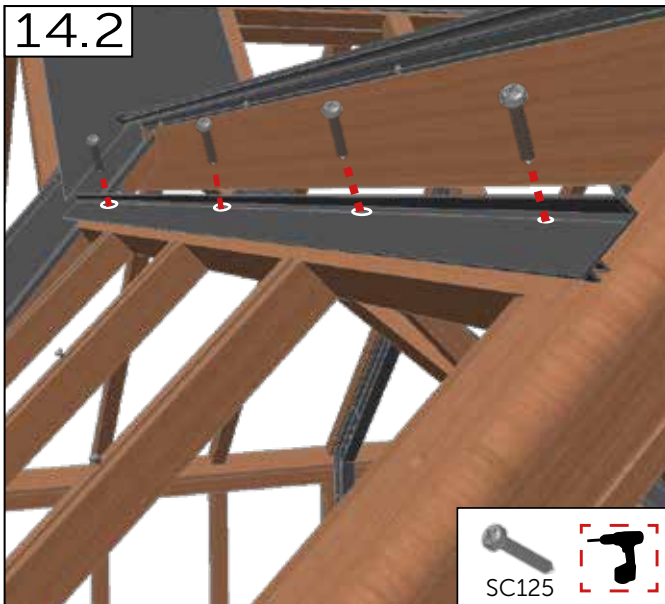

14.3

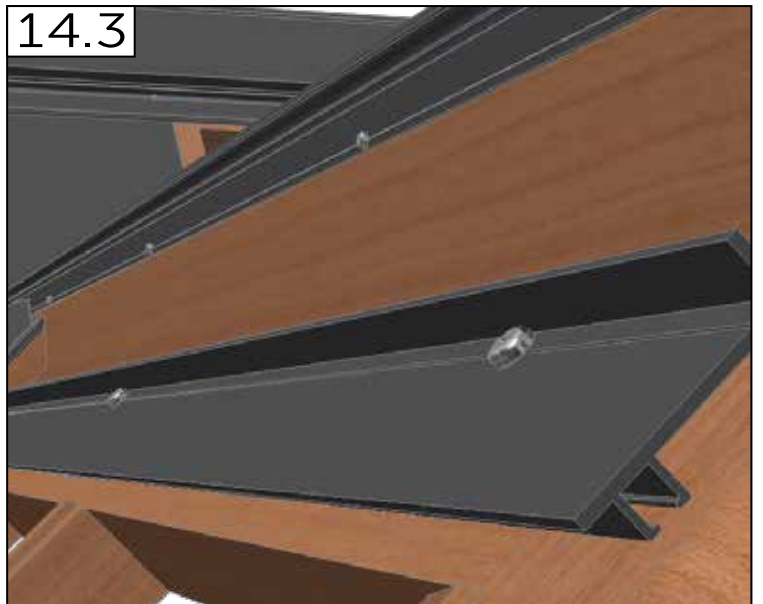

14.4

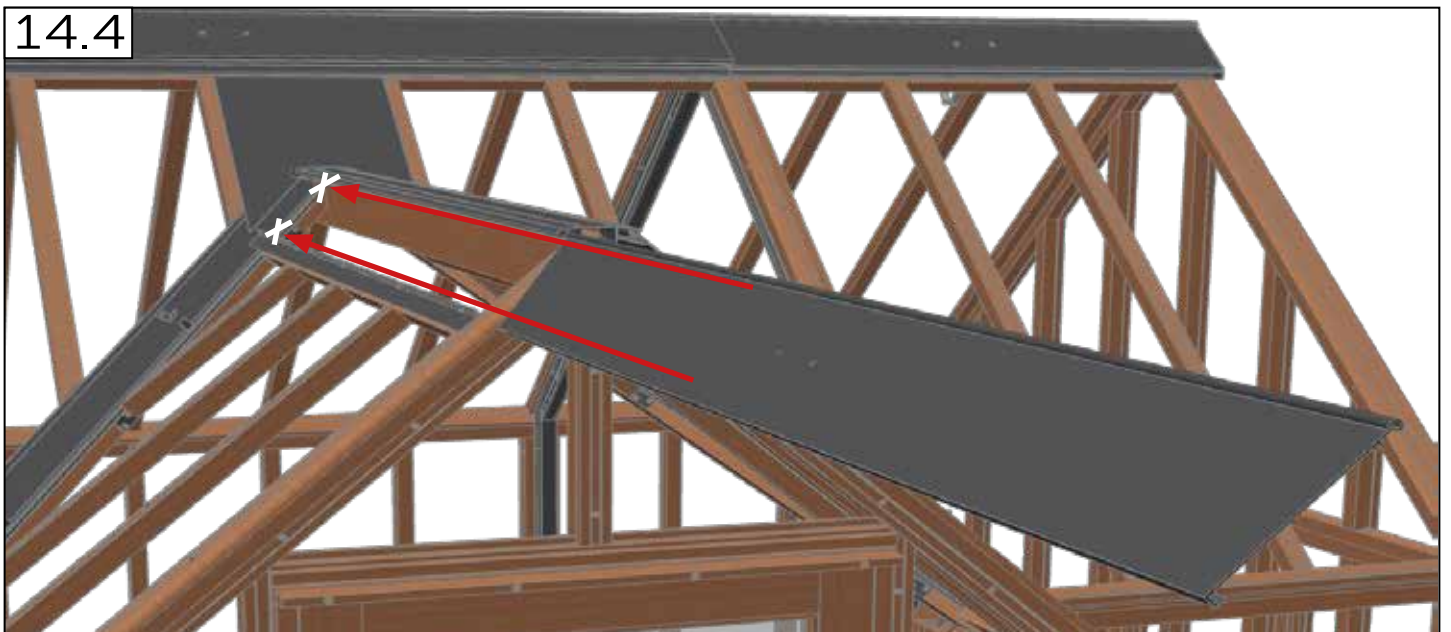

15.0

	#	mm
	AV001	-
	WA500	M6 x 16
	NU101	M6
	BL122	M6 x 16
	SC125	4.2 x 25

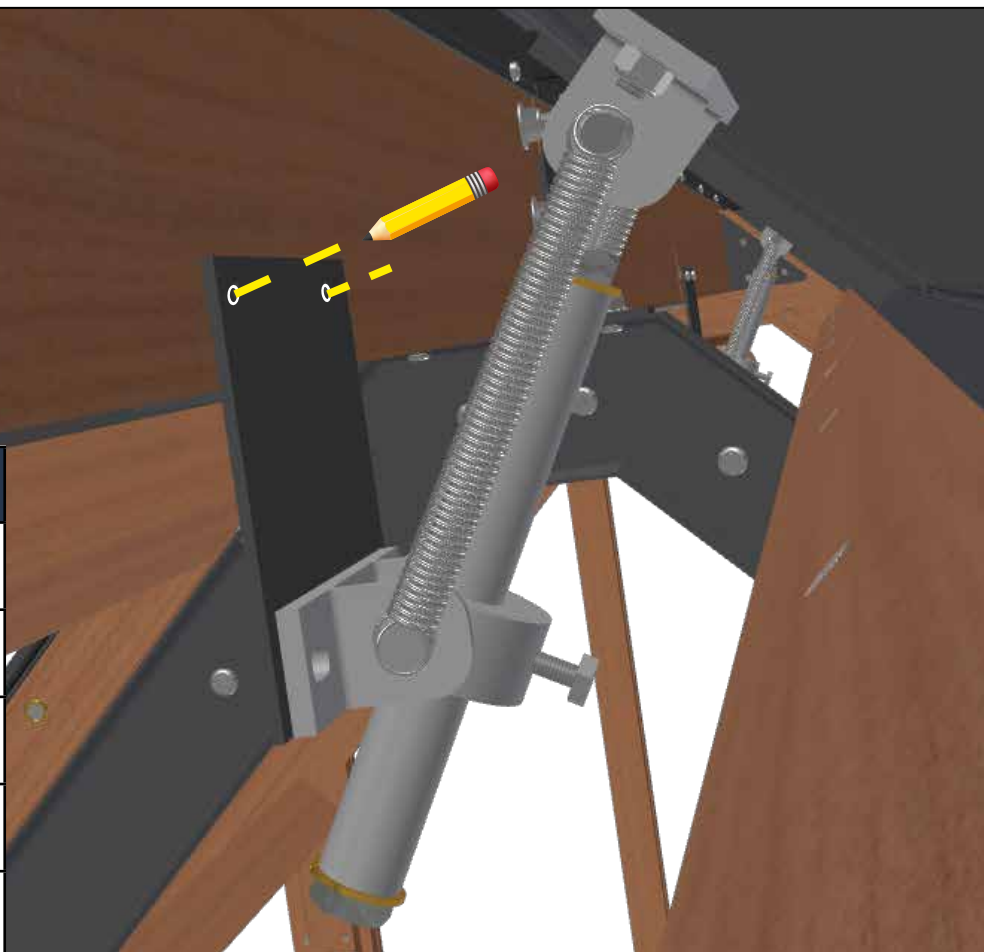

15.1

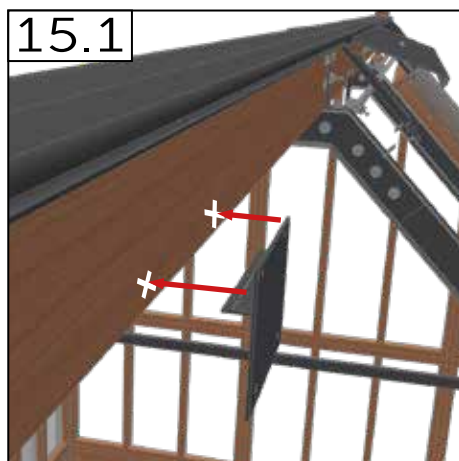

15.2

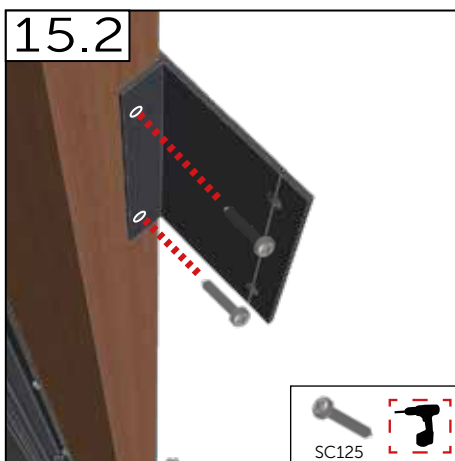

15.3

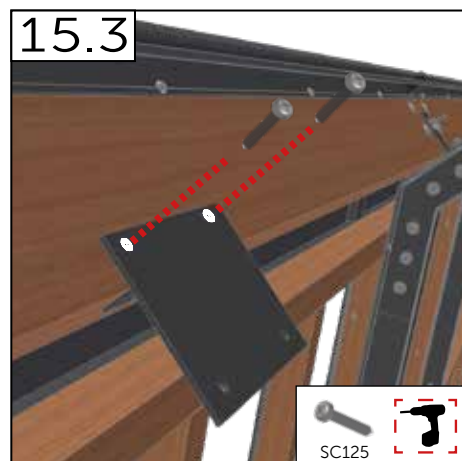

15.4

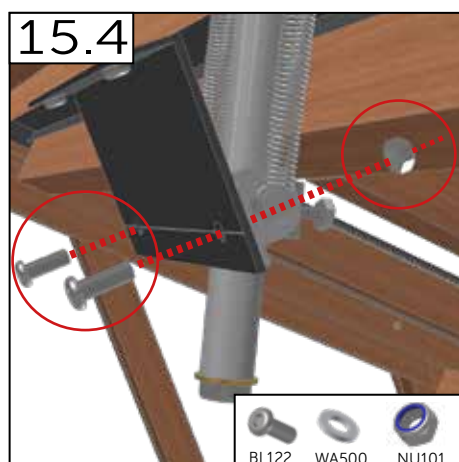

15.5

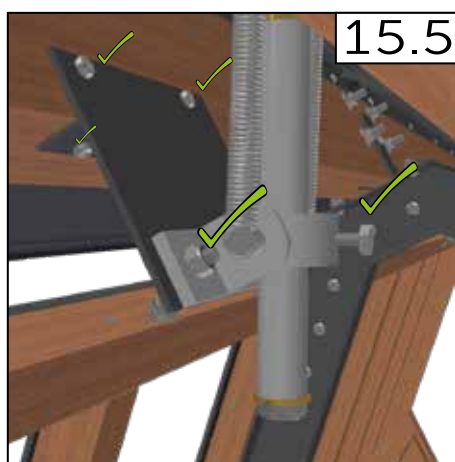

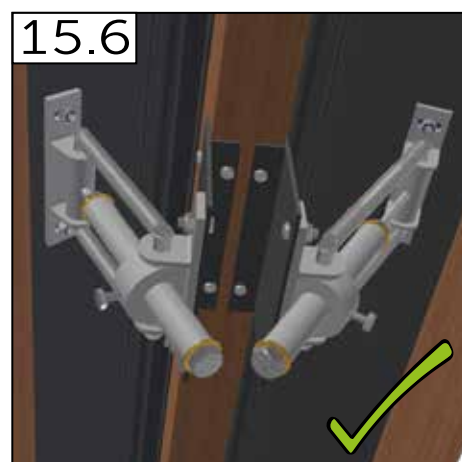

15.6

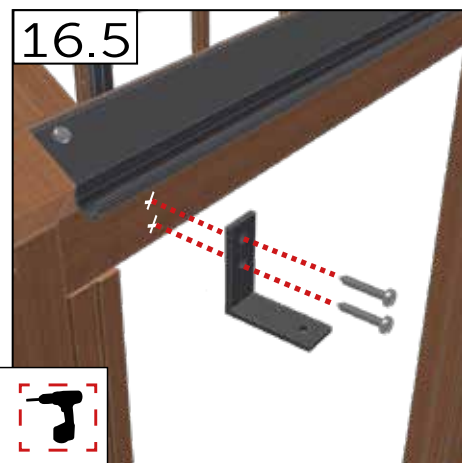
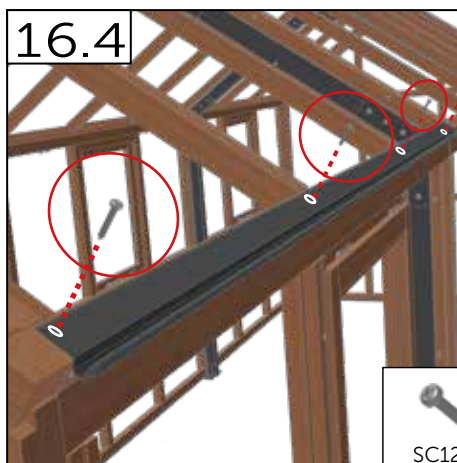
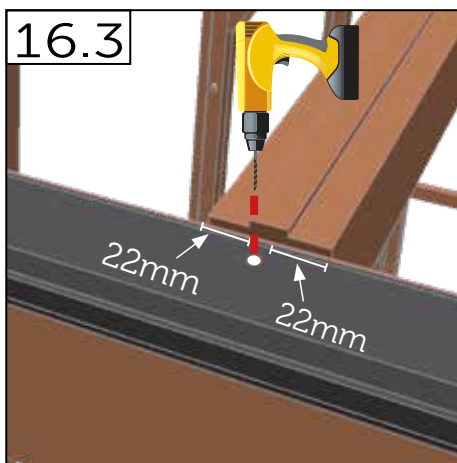
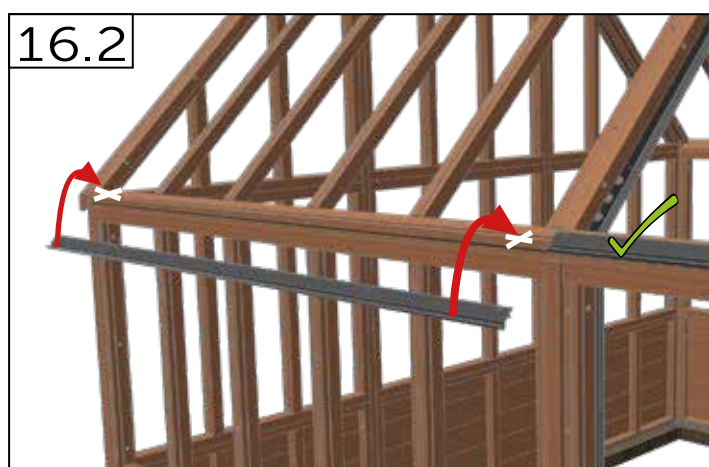

Trims - Trimmer - Trimmen - Garnitures - Versierungen - Trimmit  
 - Wykończenia - dornos



	#	mm
	A AL2022	-
	SC125	4.2 x 25
	B AL3051	-

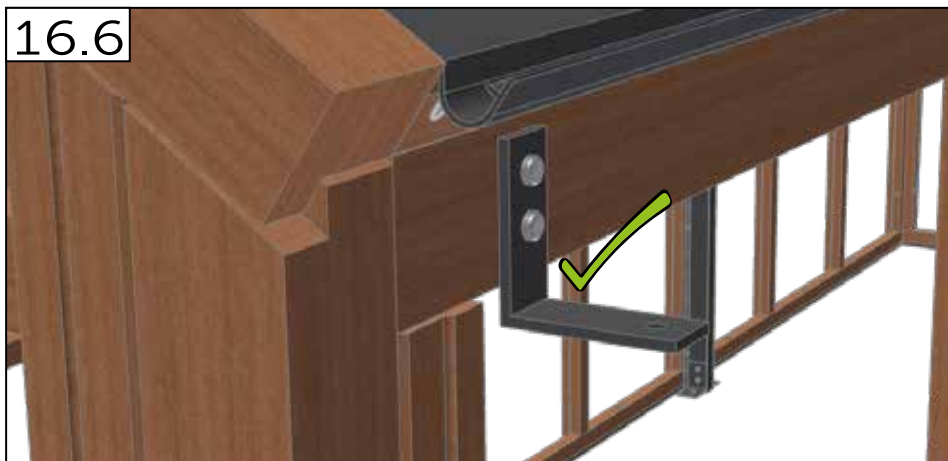

Trims - Trimmer - Trimmen - Garnitures - Versierungen - Trimmit  
 - Wykończenia - dornos

16.7



	#	mm
	A AL2022	-
	B AL2014	-
	BL122	M6 x 16mm
	WA500	M6
	NU101	M6
	SC125	4.2 x 25

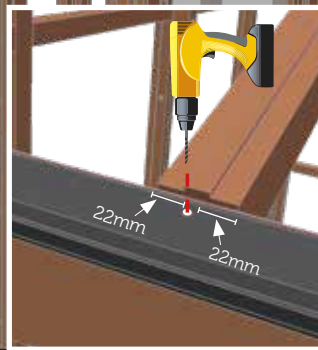

16.8

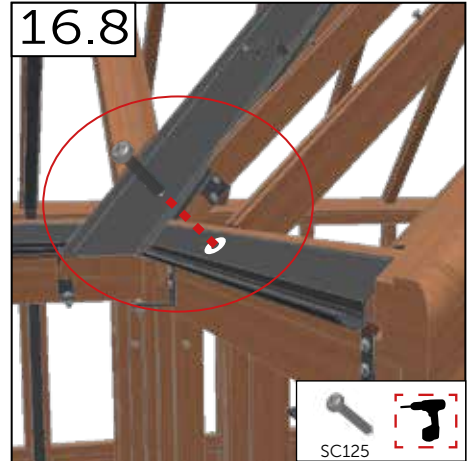

16.9



16.10

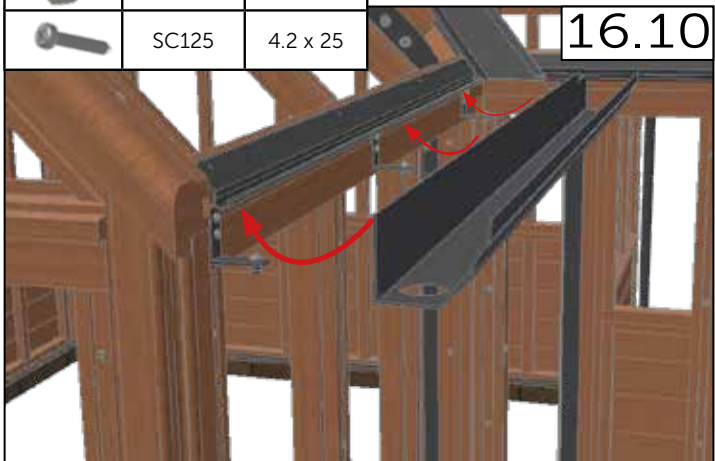

16.11

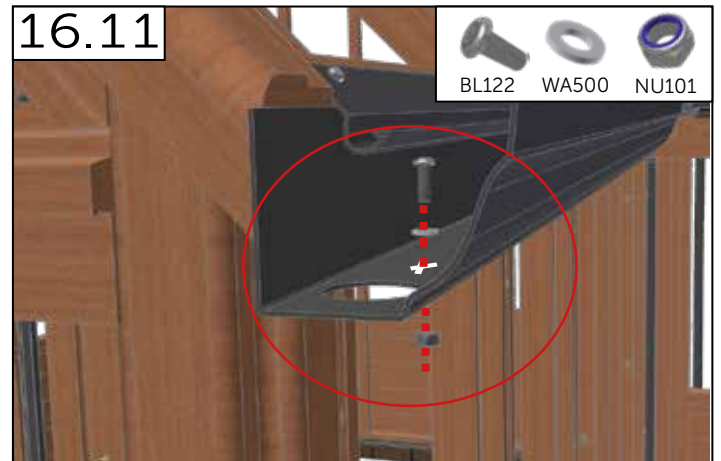

16.12

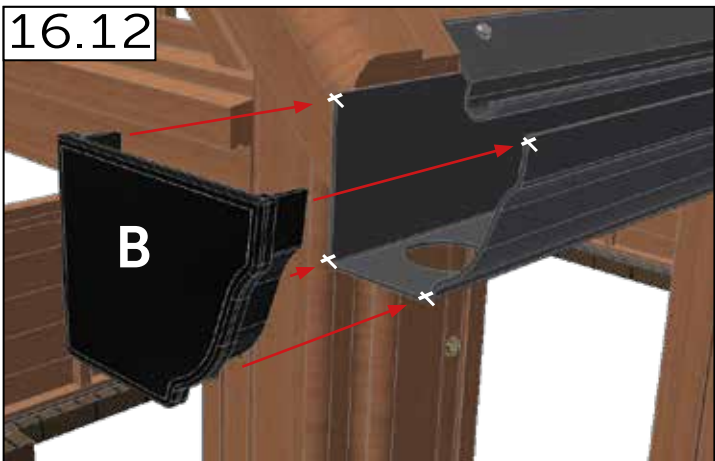

16.13

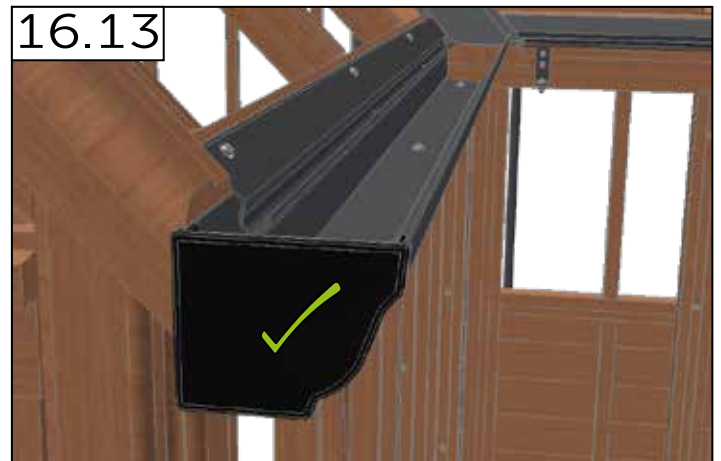

Trims - Trimmer - Trimmen - Garnitures - Versierungen - Trimmit  
 - Wykończenia - dornos

	#	mm
	B AL2014	-
	C AL2014	-
	D AL3018	-
	Silicone	-
	BL122	M6 x 16
	WA500	M6 x 16
	NU101	M6
	PT200	MALE FEMALE
	PT204	-

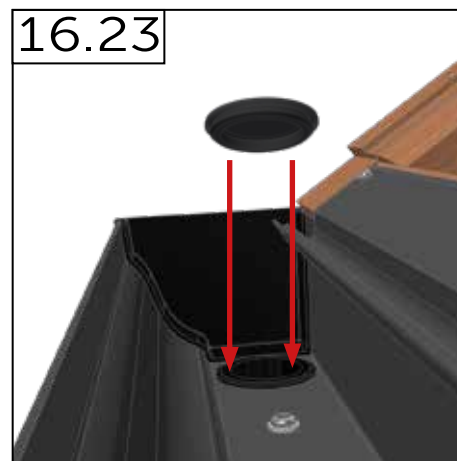
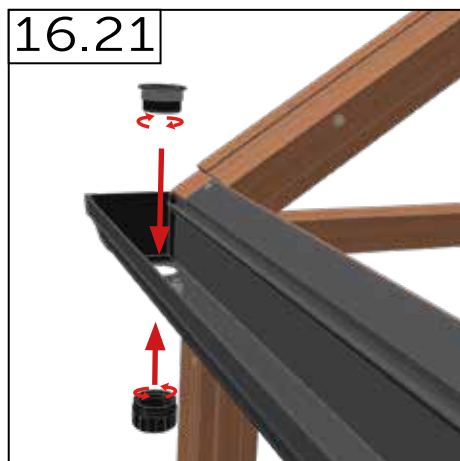
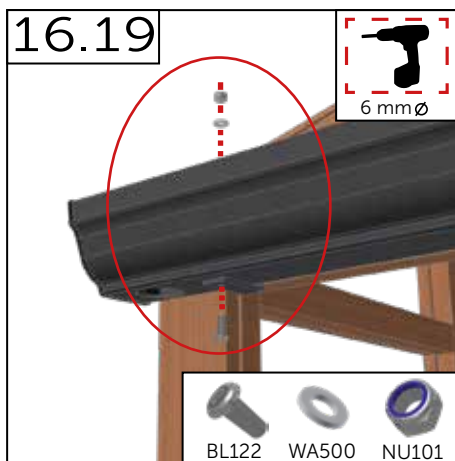
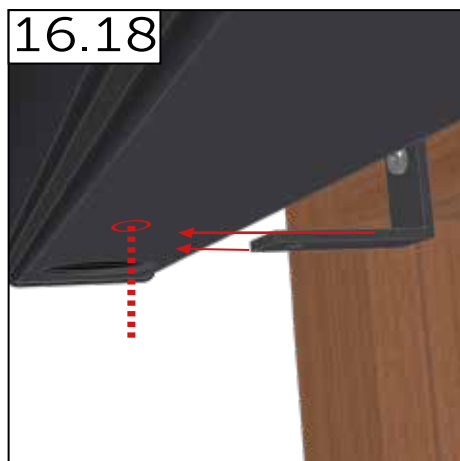
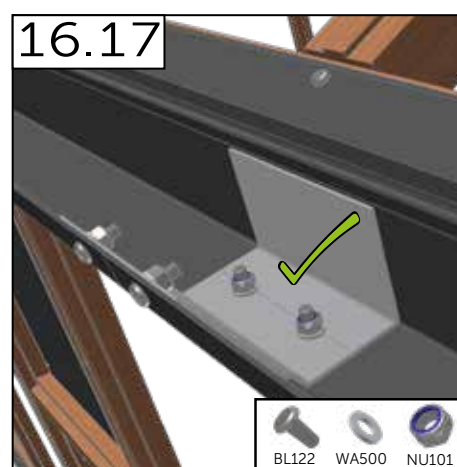
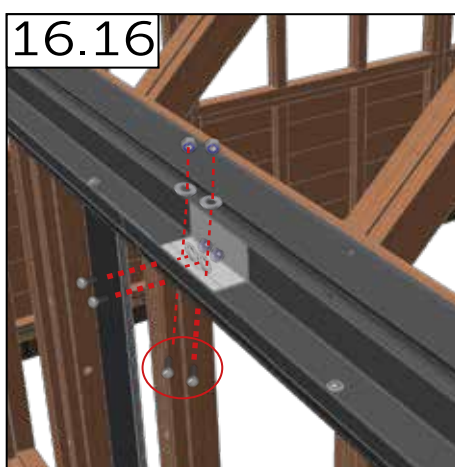
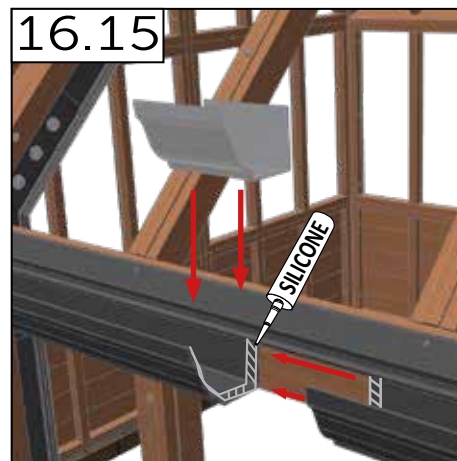
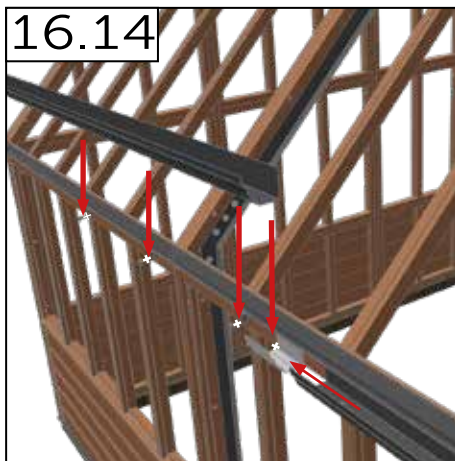

17.0

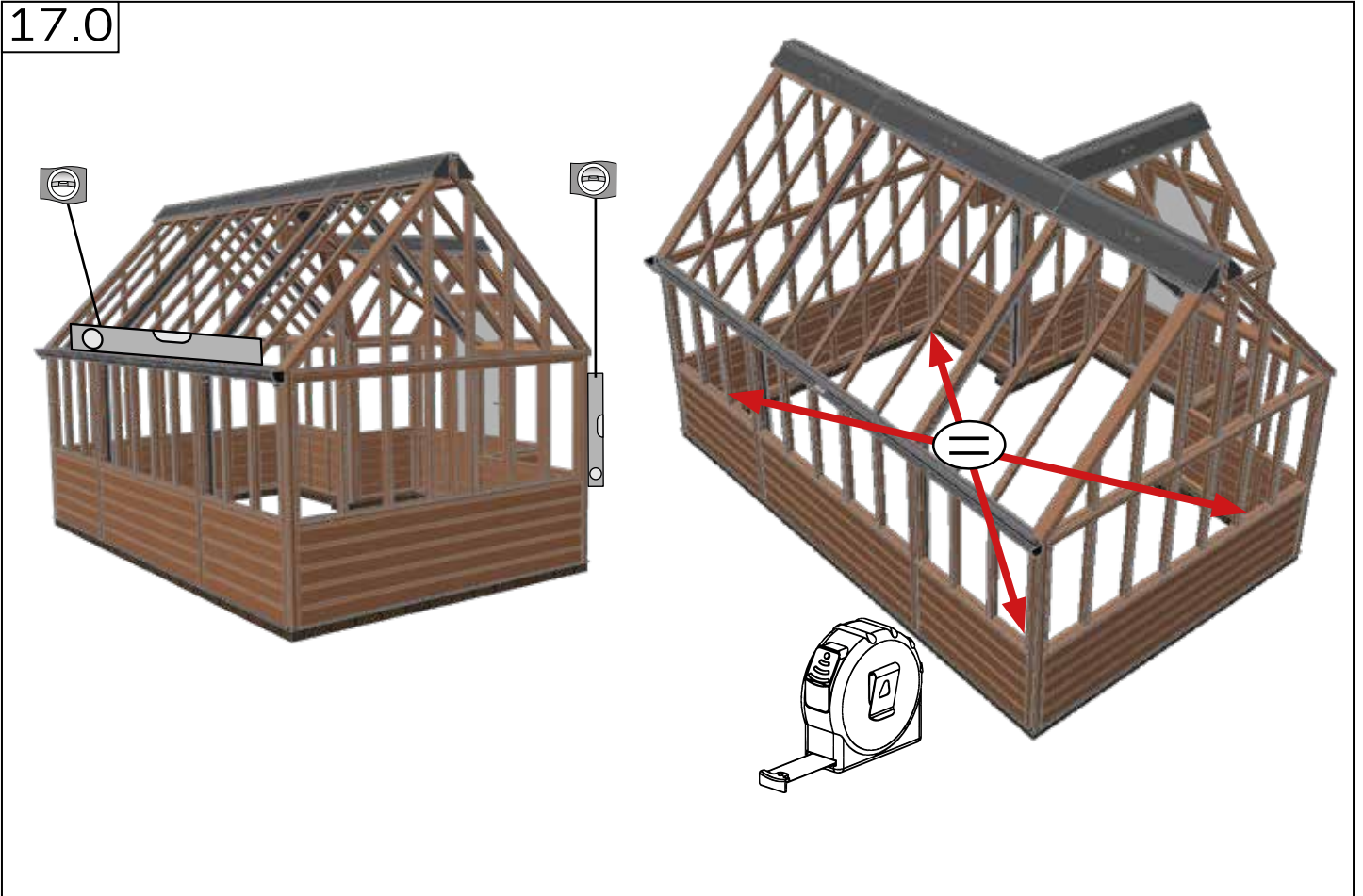

	#	mm
	SC058	4.8 x 100
	WA501	18 x 53
	FX200	8 x 40

17.1

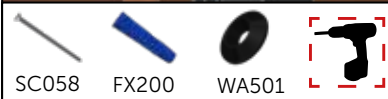
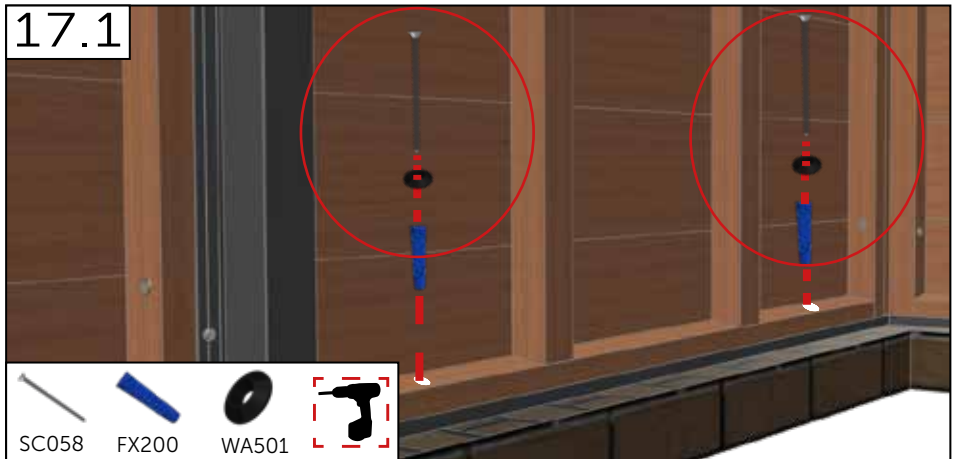

17.2

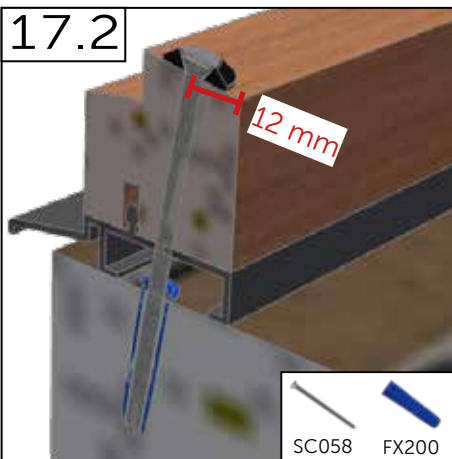

17.3

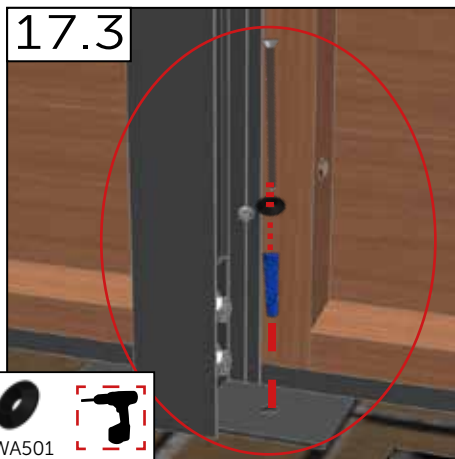

17.4

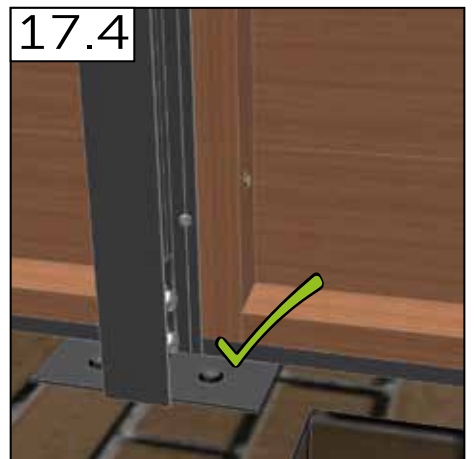



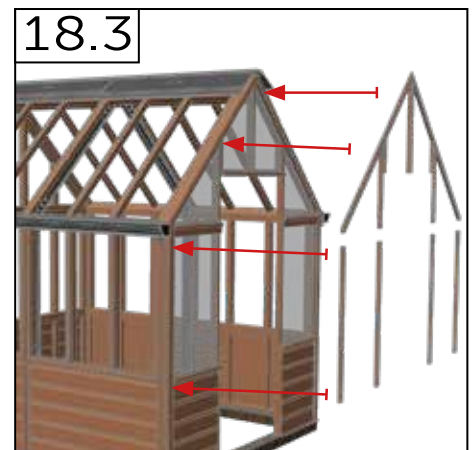
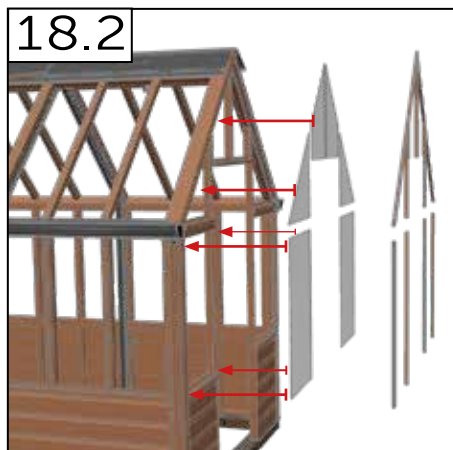
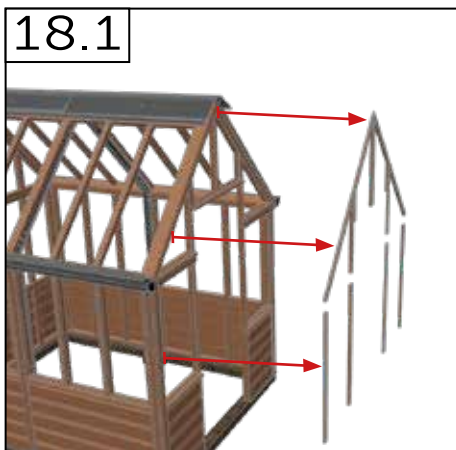
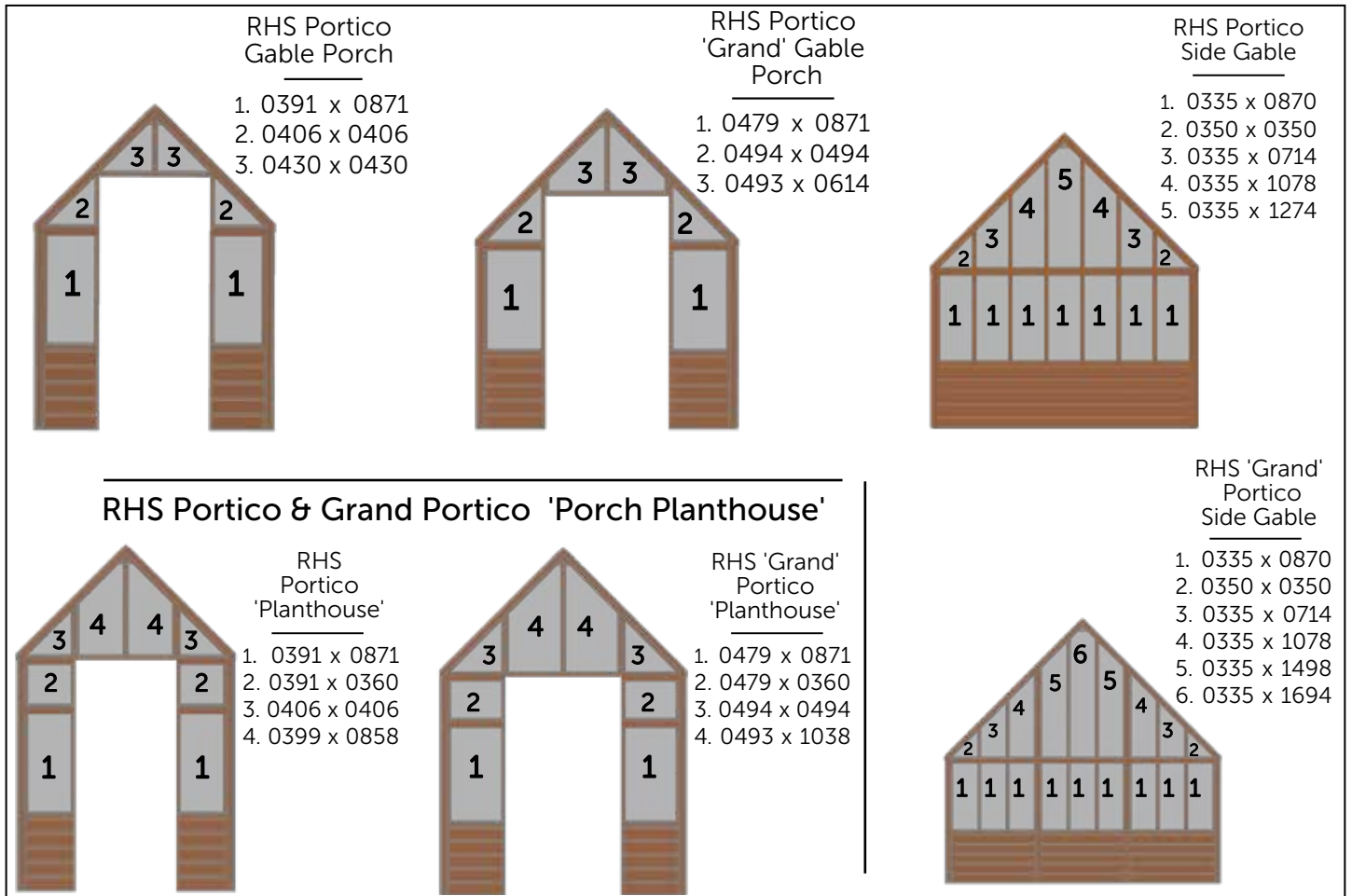

	#	mm
	GLASS	-
	A AL2009	-
	SC125	4.2 x 25
	SC305	3.5 x 32
	WA300	No. 6

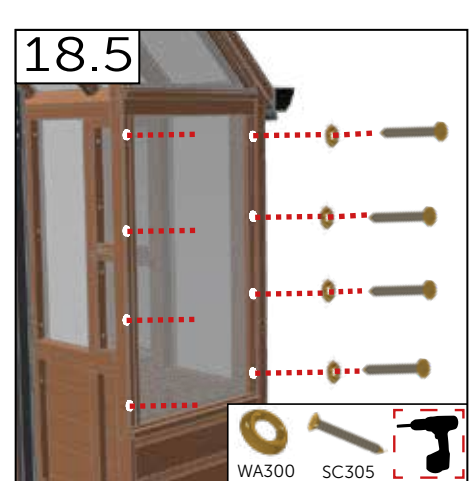
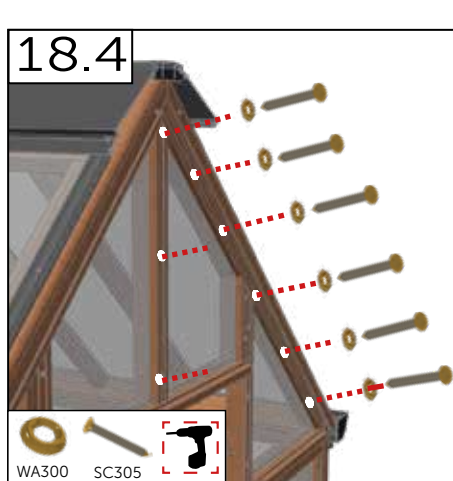

**19.0**

RHS 'Portico'

1. 0335 x 0870
2. 0405 x 1716
3. 0345 x 1716
4. 0373 x 1716

RHS 'Grand' Portico

1. 0335 x 0870
2. 0405 x 2310
3. 0345 x 2310
4. 0373 x 2310

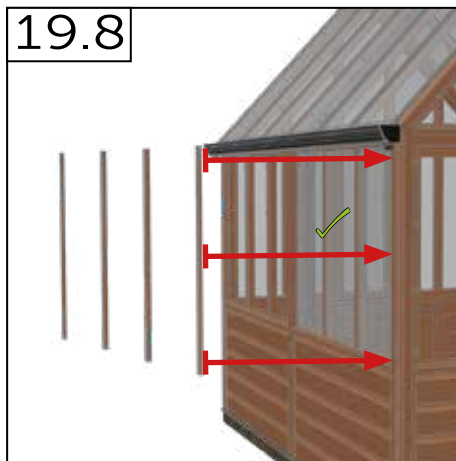
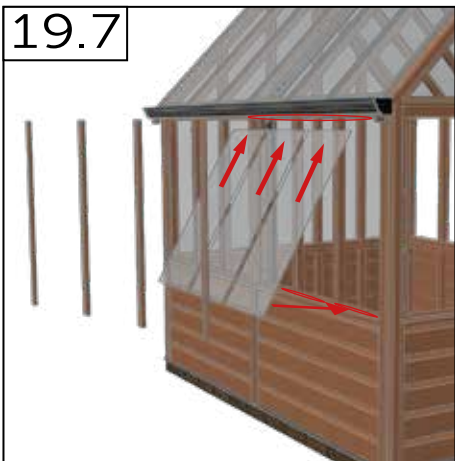
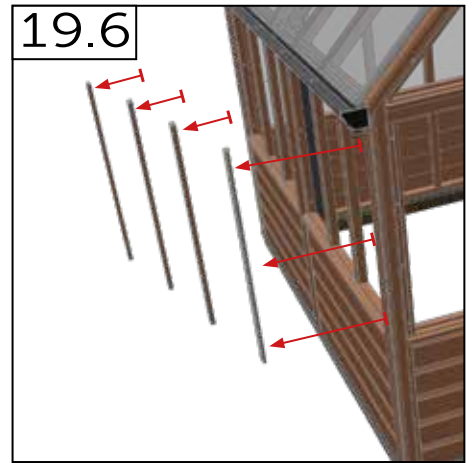
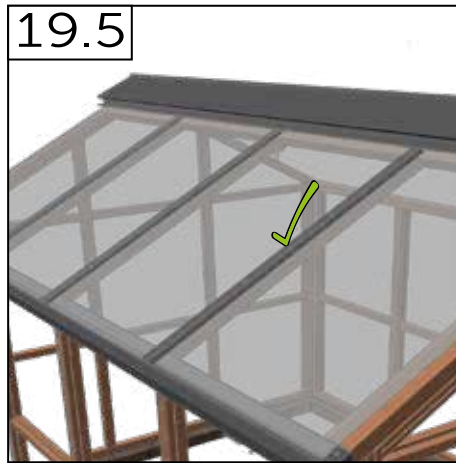
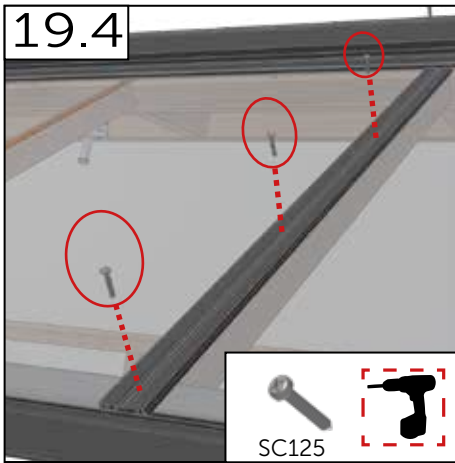
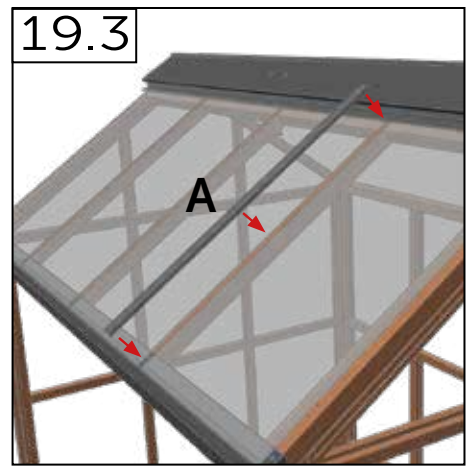
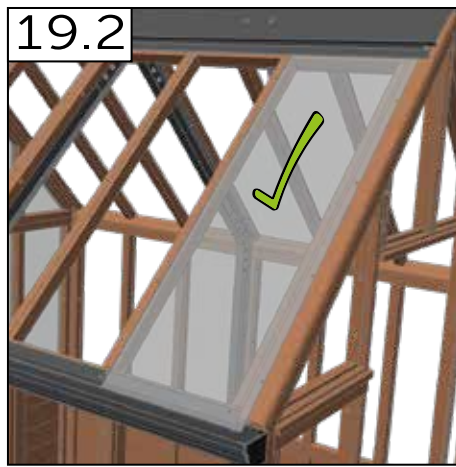
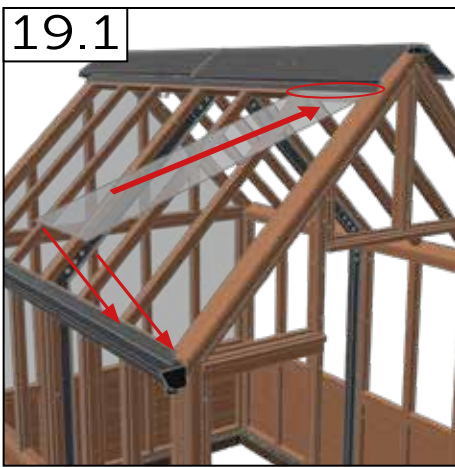

20.0

RHS Portico  
Porch

1. 0405 x 1716
2. 0345 x 1716
3. 0373 x 1716
4. 0373 x 1602
5. 0345 x 1048
6. 0339 x 0408
7. 0373 x 0345
8. 0373 x 1147
9. 0405 x 1147

RHS Grand  
Portico Porch

1. 0405 x 2310
2. 0345 x 2310
3. 0373 x 2310
4. 0373 x 2197
5. 0345 x 1642
6. 0345 x 0587
7. 0521 x 0737
8. 0373 x 1292
9. 0373 x 1405
10. 0405 x 1405

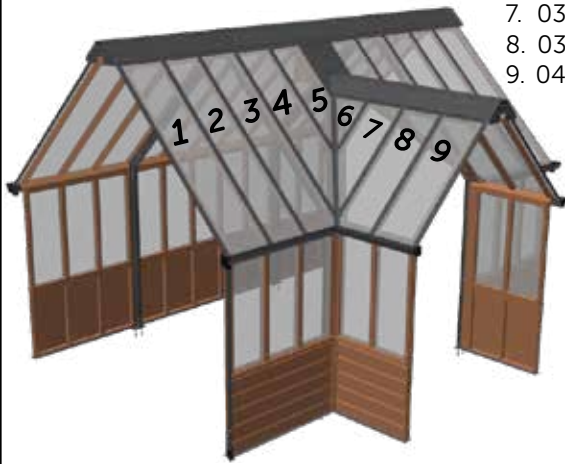

20.1

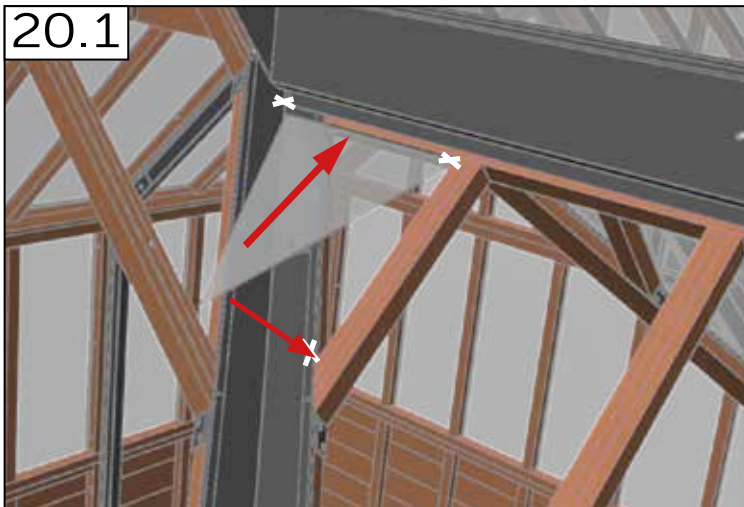

20.2

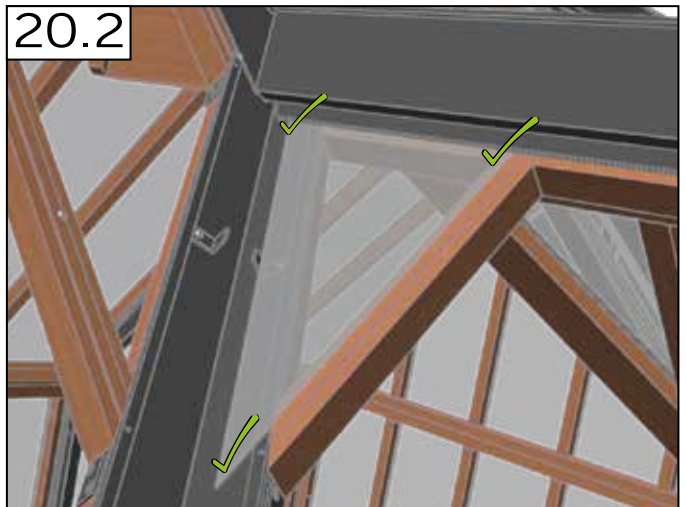

20.3

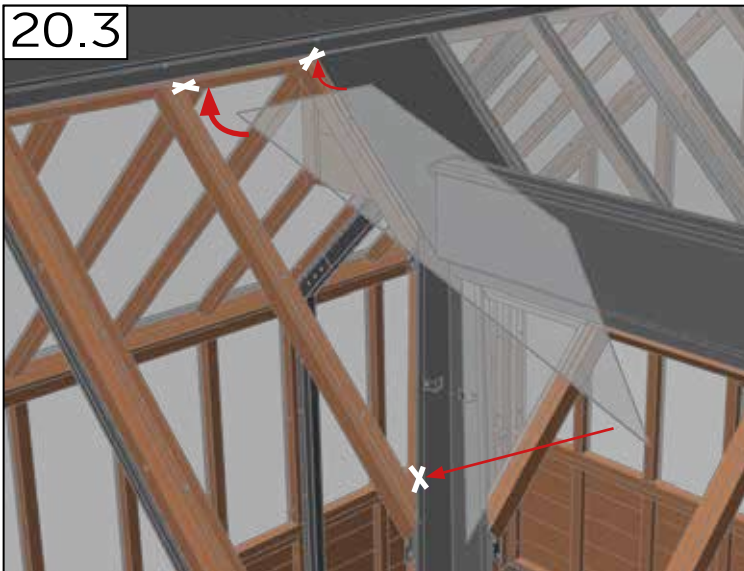

20.4

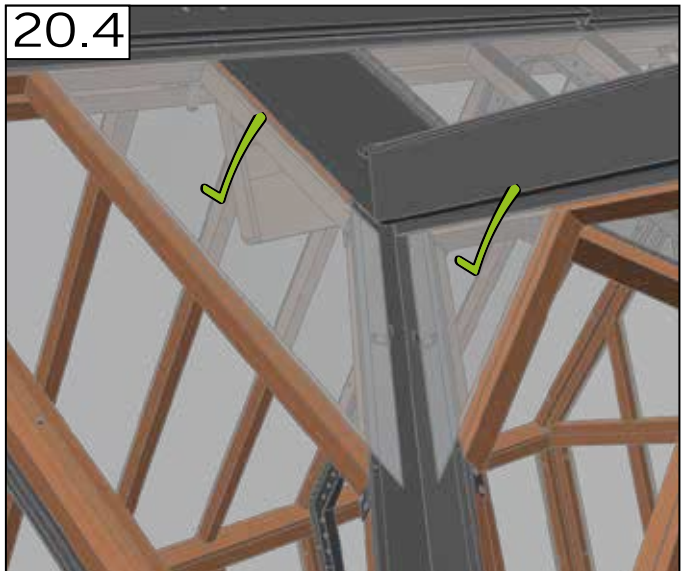

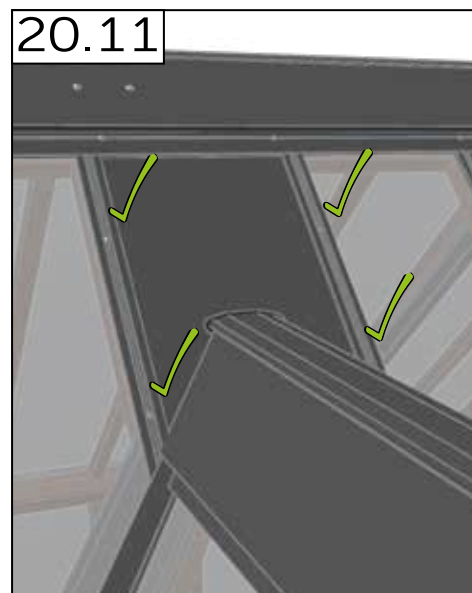
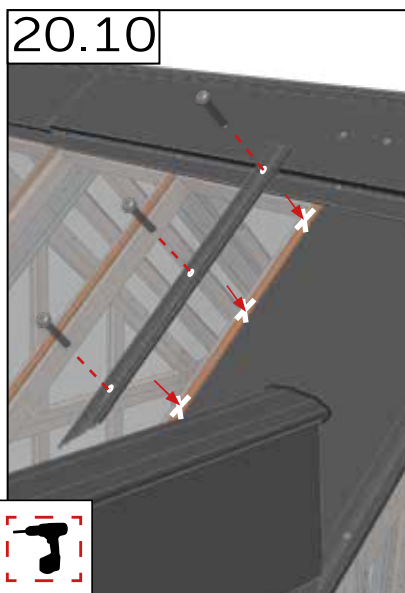
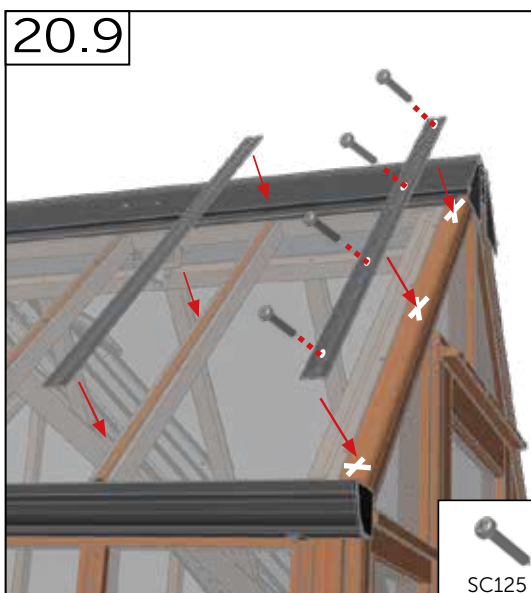
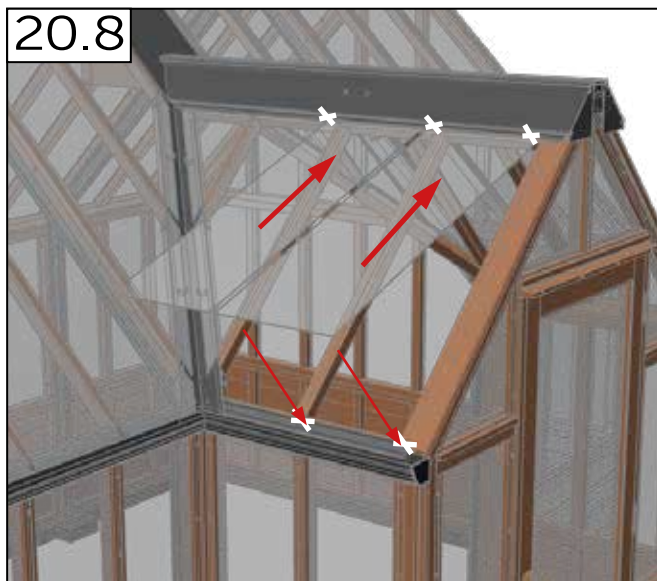
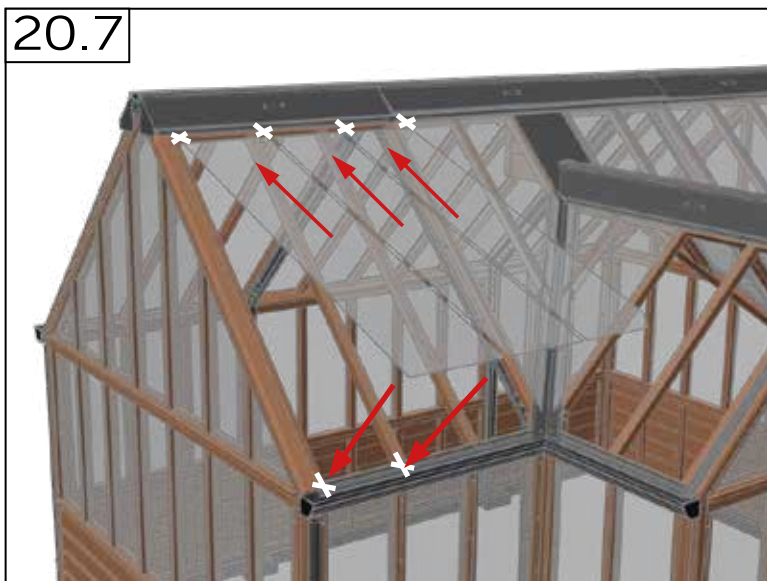
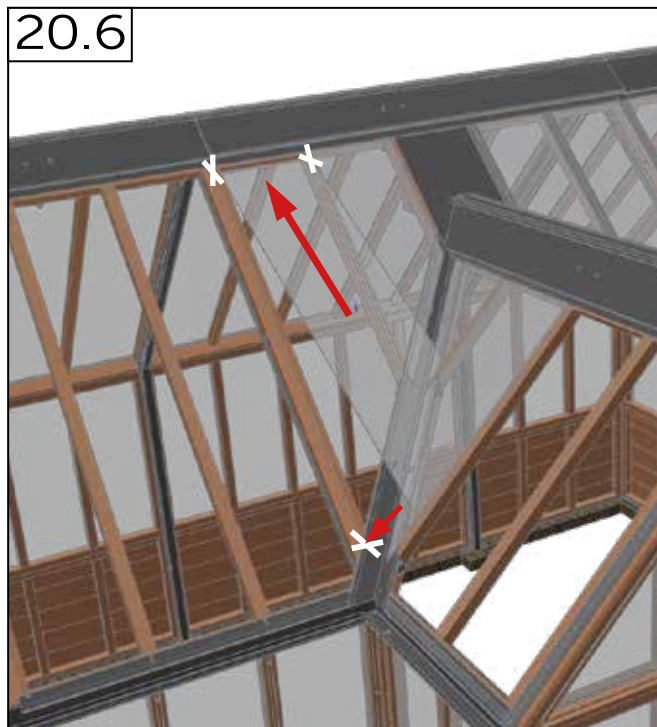
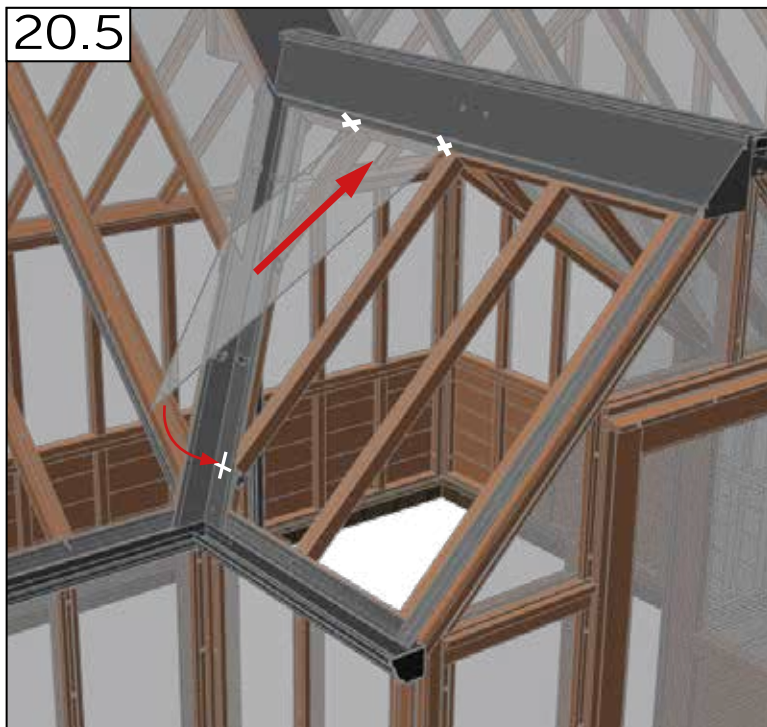

Finishing - Finition - Efterbehandling - Abschluss - Efterbehandling  
 - Refinamiento - Efterbehandling

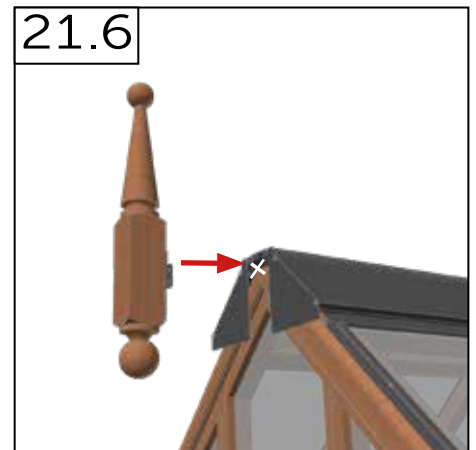
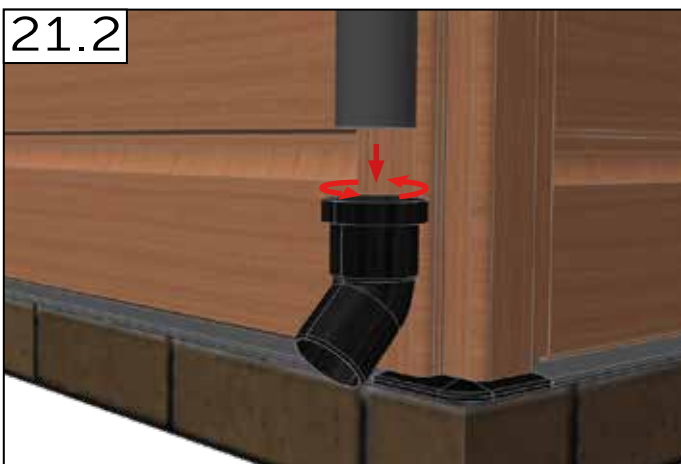
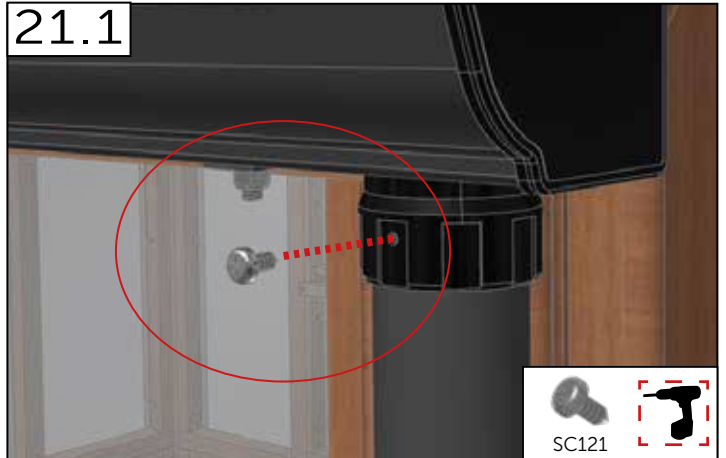
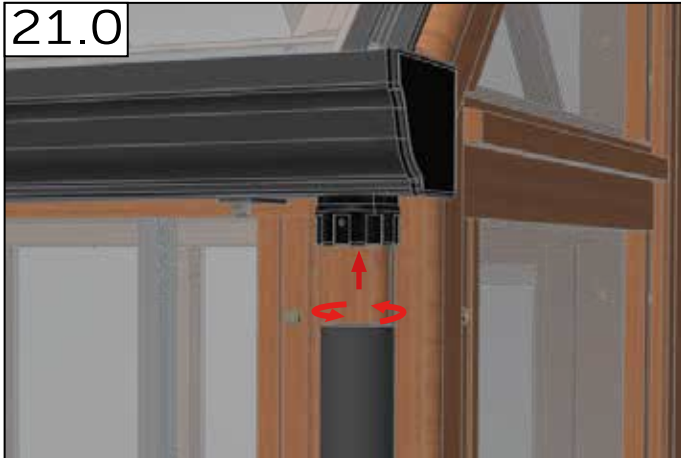

	#	mm
	SC121	4.2 x 9.5
	SC125	4.2 x 25
	SC024	4.2 x 38
	AL2016	1447
	PT201	-
	PT203	-
	W491	-

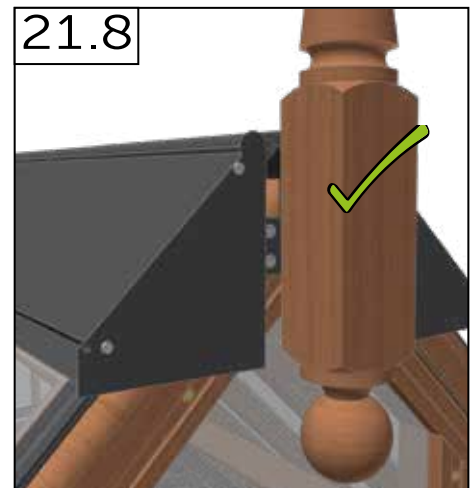
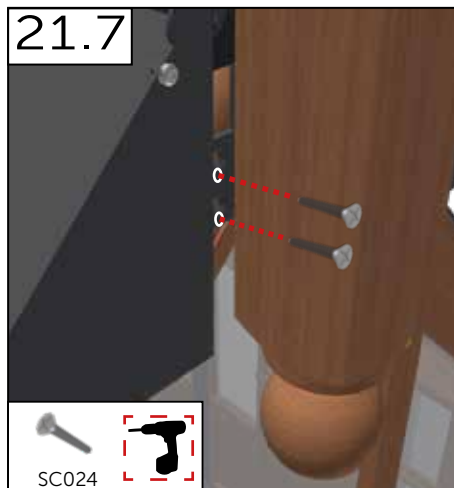







GABRIEL ASH

[www.gabrielash.com](http://www.gabrielash.com)

As part of our policy of continuous development and improvement.  
We reserve the right to modify any of the information set out within this document and any related documentation at any time without notice.

This product is delivered by a company in the Juliana Group - [www.juliana.com](http://www.juliana.com)

©The Royal Horticultural Society. The Royal Horticultural Society, and its logo, are trade marks of The Royal Horticultural Society.

(Registered Charity No. 222879/SC038262) and used under licence from RHS Enterprises Limited.